

Colour
is our nature



Installing and configuring LINEARdrive 100/S



A Mounting the LINEARdrive

⚠ Pay attention when connecting the LED groups: polarity reversal results in no light output and often damages the LEDs

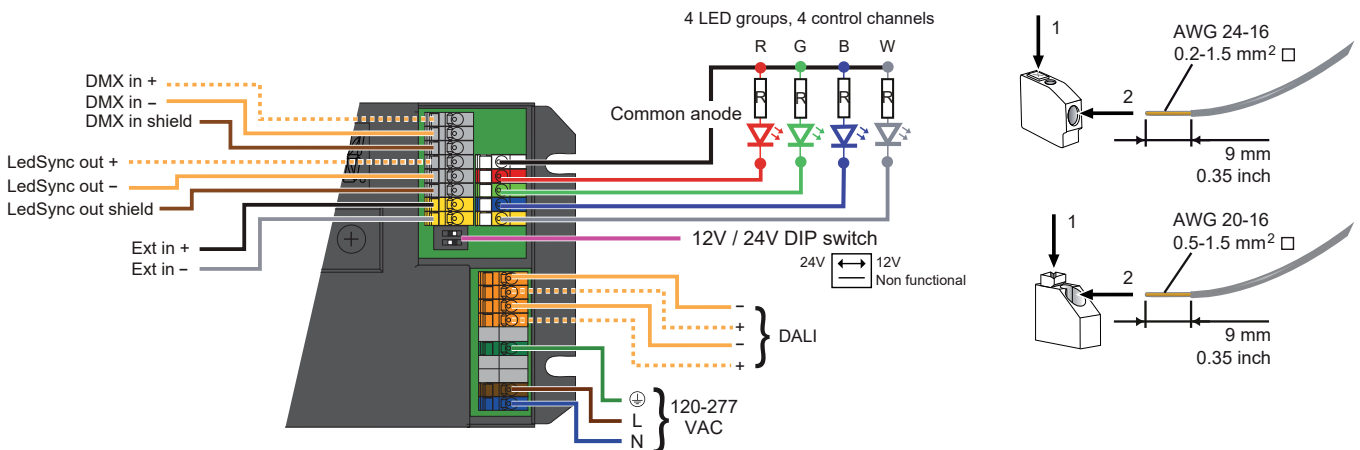

B Making the wire connections and setting the voltage



C Configuring the LINEARdrive

⚡ **WARNING:** Risk of electrical shock. May result in serious injury or death. Disconnect power before servicing or installing.

⚠ **CAUTION:** The device may only be connected and installed by a qualified electrician. All applicable regulations, legislation and building codes must be observed. Incorrect installation of the device can cause irreparable damage to the device and the connected LEDs.

Manual configuration

1. Select mode of operation

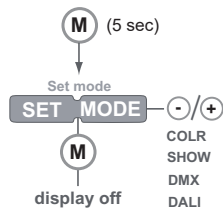

2. Set LED groups

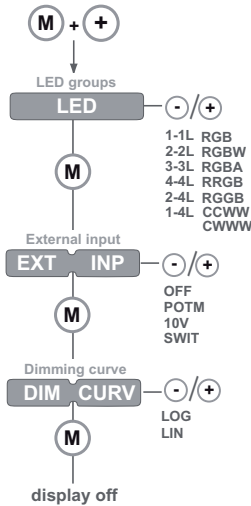

3. Standalone operation - Colour* -

or

Standalone operation - Show -

or

Networked operation - DMX or DALI -

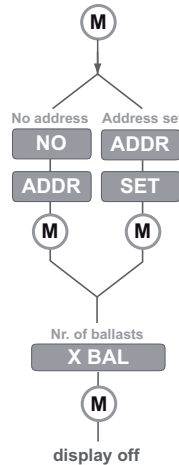
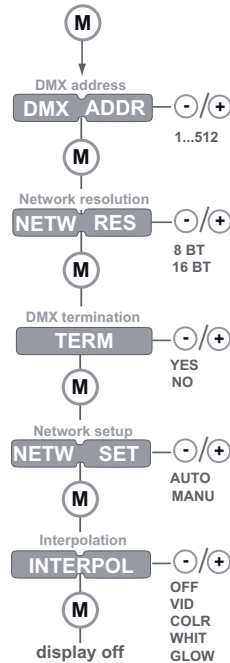
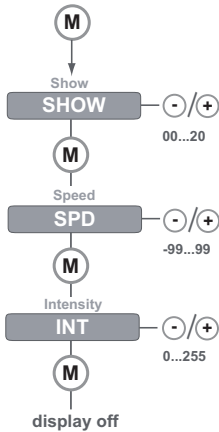
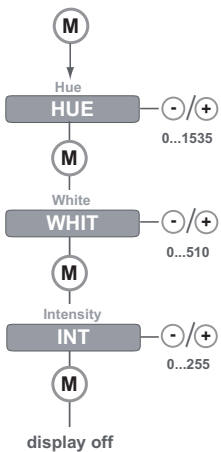

* The colour menu depends on the LED group settings you have selected in step 2.

Other features

Locking the configuration

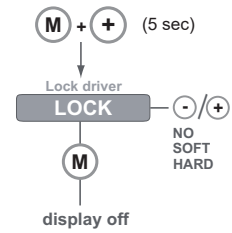

Visual test run

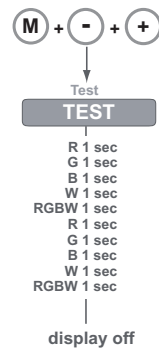

Reset to factory defaults

