

### Quick Start



<b>Panel Descriptions</b> .....	<b>2</b>
Front Panel .....	2
Rear Panel (Connecting the Equipment).....	2
<b>Getting Ready</b> .....	<b>4</b>
Getting Your Guitar/Bass Ready .....	4
Connecting the Equipment .....	4
Turning the Power On .....	4
Specifying the Device Connected to OUTPUT Jacks (OUTPUT SELECT).....	4
Making Pickup Settings (GK SETTING) .....	5
Adjusting the Volume .....	6
Using the Tuner.....	6
Selecting a Scene .....	6
About the Play Screen .....	6
<b>USING THE UNIT SAFELY</b> .....	<b>7</b>
<b>IMPORTANT NOTES</b> .....	<b>7</b>
<b>Main Specifications</b> .....	<b>8</b>

Before using this unit, carefully read “USING THE UNIT SAFELY” and “IMPORTANT NOTES” (the leaflet “USING THE UNIT SAFELY” and Quick Start ( p. 7)).After reading, keep the document(s) where it will be available for immediate reference.

© 2023 Roland Corporation

#### Quick Start (this document)

Read this first. It explains the basic things you need to know in order to use the GM-800.

#### PDF Manual (download from the Web)

- **Reference Manual**  
This provides even more details on the functions and operations of this unit.
- **Parameter Guide**  
This explains all parameters of the GM-800.
- **Sound List**  
This is a list of the sounds built into the GM-800.
- **MIDI Implementation**  
This is detailed information about MIDI messages.

#### To obtain the PDF manual

**1. Enter the following URL in your computer.**

[https://roland.cm/boss\\_om](https://roland.cm/boss_om)



**2. Choose “GM-800” as the product name.**

# Panel Descriptions

## Front Panel



### 1 [OUTPUT LEVEL] knob

Adjusts the overall volume.

### 2 PART [1]–[4], [R] buttons

Switches to the part settings screen.

When you press these buttons while the part settings screen is displayed, the buttons switch the parts on/off.

### 3 Display

Various information regarding the GM-800 is indicated here.

### 4 [1]–[4] knob, [SELECT] knobs

Use this to select or edit the value of the parameter that's shown in the display.

### 5 [EXIT] button

Used to return to previous screens and to undo operations.

### 6 [WRITE] button

Press this to save the scene settings or to copy.

### 7 [MENU] button

Switches to the MENU screen.

\* Hold down the [EXIT] button and press the [MENU] button to switch the knob lock function (\*) on/off.

(\*) When this is ON, knob operations are disabled on the play screen.

### 8 PAGE [◀][▶] buttons

Switches between pages.

### 9 [▲][▼] switches

Switch scenes.

### 10 [CTL1][CTL2] switches

These switches control the functions set for each scene.

## Rear Panel (Connecting the Equipment)

### 11 GK IN jack

Connect a guitar or bass equipped with the BOSS Divided Pickup (GK-5/GK-5B) to this connector.

\* **Never connect anything other than the dedicated serial GK cable.**

### 12 GK OUT jack

Use this jack to connect multiple GM-800s, or to connect to a compatible device with a GK IN jack.

### 13 OUTPUT jacks

Connect these jacks to your guitar amp, PA (LINE), or headphones (sold separately).

\* Connect your headphones to the L/PHONES jack.

\* If your system is mono, use only the R/MONO jack.

\* If you're using headphones, don't connect anything to R/MONO jack.

### 14 MIDI (OUT/IN) connectors

These connectors transmit and receive MIDI messages to/from connected external MIDI devices.

### 15 CTL3, 4/EXP1, CTL5, 6/EXP2 jacks

You can connect an expression pedal (EV-30, FV-500L, FV-500H, or Roland EV-5: sold separately) or footswitch (FS-5U, FS-6, FS-7: sold separately), and use it to control various functions.

➔ For details on the settings, refer to "Reference Manual" (Roland website).

### 16 USB (COMPUTER) port

Use a commercially available USB 2.0 cable to connect this port to your computer.

This port lets you use the dedicated editor software or transfer USB MIDI and USB audio data.

\* You must install the USB driver before connecting this unit to a computer. Download the USB driver from the BOSS website. For details, refer to Readme.htm which is included in the download.

**17 USB (MEMORY) port**

Connect a USB flash drive. Connect or disconnect the USB flash drive while the GM-800 is powered off.

\* Never turn off the power or remove the USB flash drive while the access indicator is blinking, or while the screen shows that an operation is in progress.

**18 DC IN jack**

Connect the included AC adaptor here.

\* The DC IN jack also serves as the power switch. The power turns on when you insert a plug into the DC IN jack, and the power turns off when you unplug the cable.

**19 Ground terminal**

Connect this to an external earth or ground if necessary.

\* To prevent malfunction and equipment failure, always turn down the volume, and turn off all the units before making any connections.

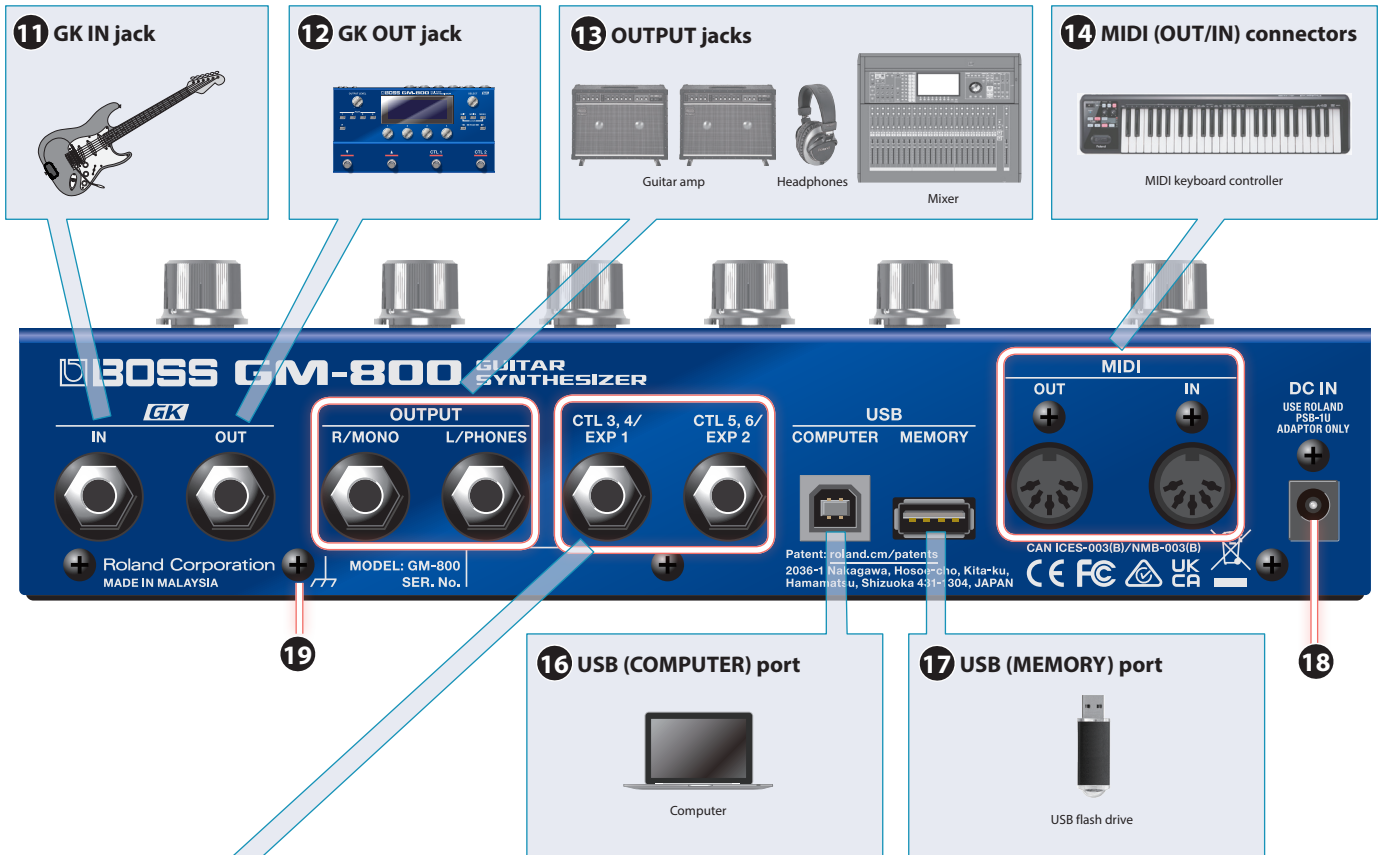

**15 CTL3, 4/EXP1, CTL5, 6/EXP2 jacks**

To use these as EXP 1, EXP 2 jacks  
Connect an expression pedal.

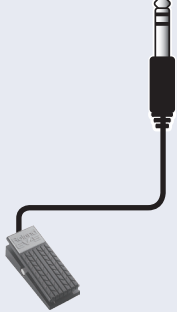

\* Use only the specified expression pedal (EV-30, FV-500L, FV-500H, or Roland EV-5; sold separately). By connecting any other expression pedals, you risk causing malfunction and/or damage to the unit.

To use these as CTL 3, 4 or CTL 5, 6 jacks  
Connect a footswitch.

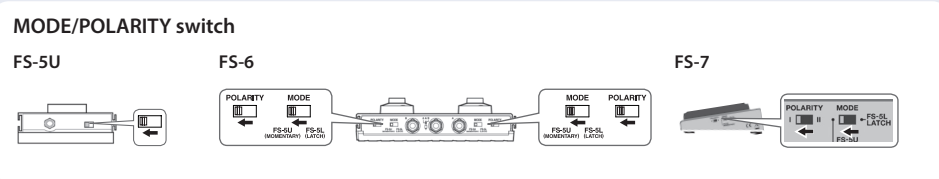
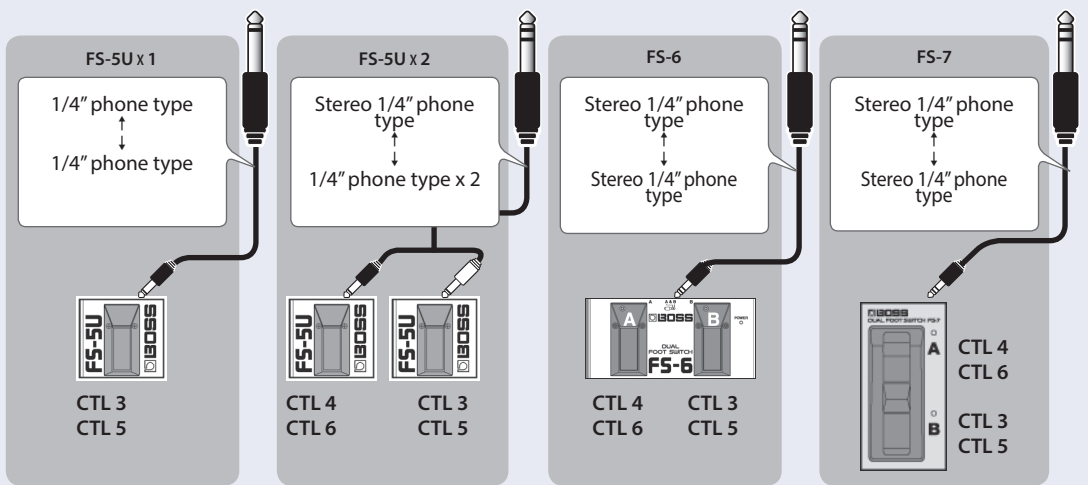

# Getting Ready

## Getting Your Guitar/Bass Ready

- To use the GM-800, your guitar or bass guitar must have a divided pickup (GK pickup) installed that can output independent signals for each separate string, such as the BOSS GK-5 or GK-5B.
- See the GK pickup Owner's Manual for instructions on how to install the GK pickup.
- Note that fret buzzing due to warping of the neck or worn-down frets, or discrepancies due to octave tuning may result in misrecognition of your playing.

## Connecting the Equipment

➔ Refer to "Rear Panel (Connecting the Equipment)" (p. 2)

### Attaching the Rubber Feet

You can attach the rubber feet (included) if necessary.

Attach them in the locations shown in the illustration.

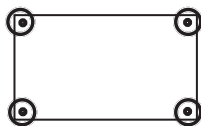

- \* Using the unit without rubber feet may damage the floor.
- \* When turning the unit over, be careful so as to protect the buttons and knobs from damage. Also, handle the unit carefully; do not drop it.

## Turning the Power On

- \* Before turning the unit on/off, always be sure to turn the volume down. Even with the volume turned down, you might hear some sound when switching the unit on/off. However, this is normal and does not indicate a malfunction.
- \* To turn the power off, reverse the order.

1. Turn the volume all the way down on your guitar amp and other devices connected to this unit.
2. Connect your equipment to the OUTPUT jack(s).
3. Connect your guitar, etc.
4. Plug the included AC adaptor into the DC IN jack of this unit.  
This turns the power on.
5. Turn on your guitar amp and other devices connected to this unit.

## Specifying the Auto Off function

The power to this unit will be turned off automatically after a predetermined amount of time has passed since it was last used for playing music, or its buttons or controls were operated (Auto Off function). If you do not want the power to be turned off automatically, disengage the Auto Off function.

- \* Any settings that you are in the process of editing will be lost when the power is turned off. If you have any settings that you want to keep, you should save them beforehand.
- \* To restore power, turn the power on again.

➔ For details on the settings, refer to "Reference Manual" (Roland website).

## Specifying the Device Connected to OUTPUT Jacks (OUTPUT SELECT)

1. Press the [MENU] button.
2. Use the PAGE [◀] [▶] buttons to access the "IN/OUT SETTING" icon.



3. Press the [4] knob.

The IN/OUT SETTING screen appears.



4. Turn the [SELECT] knob to move the cursor to the "OUTPUT SELECT".



5. Turn the [1] knob, and select the connected device.

OUTPUT SELECT	Explanation
LINE/PHONES	Choose this setting if you're using headphones, or if the GM-800 is connected to a keyboard amp, mixer, or digital recorder.
GUITAR AMP	Choose this setting if the GM-800 is connected to the input jack of the guitar amp.

- \* To use this unit with a bass guitar amp, use the LINE/PHONES setting.

## Making Pickup Settings (GK SETTING)

Make settings for the divided pickup in order to ensure that you'll always be playing the GM-800 in the optimal state. The GM-800 can save twenty types of these settings (GK SETTING).

Here we explain the example of saving pickup settings in GK SET: [01].

### MEMO

The GK SETTING is saved even when the power is turned off. You don't need to make this setting again each time you perform.

1. Press the [MENU] button.
2. Use the PAGE [◀] [▶] buttons to access the "GK SETTING" icon.



3. Press the [3] knob.

The GK SETTING screen appears.



4. Turn the [SELECT] knob to move the cursor to the first line.

5. Turn the [1] knob to select GK SET: [01].

The pickup settings will be saved in GK SET: [01].

### MEMO

Pickup settings are automatically saved in the number that you selected in step 5.

## Specifying the Pickup Type

Choose the type of pickup that's installed on your guitar (bass).

6. Turn the [SELECT] knob to move the cursor to the second line.



7. Turn the [1] knob to select the pickup type.

GK TYPE	Explanation
GK-5	Choose this if you're using a BOSS GK-5.
GK-3	Choose this if you're using a Roland GK-3. *1
GK-2A	Choose this if you're using a Roland GK-2A, or if you're using a (commercially available) guitar with a built-in divided pickup. *1
GC-1	Choose this if you're using a Roland V-Guitar GC-1. *1
PIEZO	Select this when using a guitar with a piezo pickup (flat response). *1
PIEZO F	Select this when using a guitar with a piezo pickup (Fishman). *1
PIEZO G	Select this when using a guitar with a piezo pickup (Graph Tech). *1
PIEZO L	Select this when using a guitar with a piezo pickup (L.R. Baggs). *1

GK TYPE	Explanation
PIEZO R	Select this when using a guitar with a piezo pickup (RMC). *1
GK-5B	Choose this if you're using a BOSS GK-5B.
GK-3B	Choose this if you're using a Roland GK-3B. *1
GK-2B	Choose this if you're using a Roland GK-2B, or if you're using a (commercially available) bass with a built-in divided pickup. *1
PIEZO(B)	Select this when using a bass with a piezo pickup (flat response). *1
PIEZO G(B)	Select this when using a bass with a piezo pickup (Graph Tech). *1
PIEZO R(B)	Select this when using a bass with a piezo pickup (RMC). *1

\*1 Use this in combination with the GKC-AD (sold separately).

## Specifying the Pickup Position (Bass Guitar Only)

Set the GK PU Pos according to where you've installed the divided pickup on your bass guitar.

8. Turn the [2] knob, and specify the GK PU Pos.

For a 4-string bass

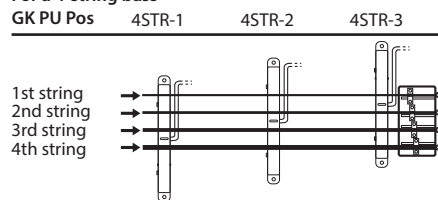

For a 5-string bass

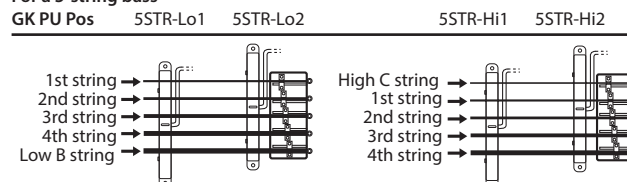

For a 6-string bass

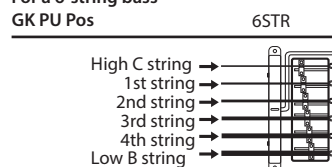

## Adjusting the Pickup Sensitivity

The volume will differ if the distances between each string and the divided pickup are different. Specify the sensitivity of the pickup to compensate for this volume difference.

9. Use the PAGE [◀] [▶] buttons to access the SENS screen.



10. Turn the [SELECT] knob to move the cursor to the string to set.

11. Turn the [4] knob to adjust the SENS value.

Play the string as strongly as you ever expect to play it in actual performance, and use the knob to adjust the sensitivity as high as possible without allowing the meter to reach the full-scale position.

If the level meter reaches the full-scale position, the level is excessive. Lower the sensitivity.

## Getting Ready

\* Depending on the guitar (bass) you're using, the level meter might reach full-scale even if the sensitivity is at minimum. If this is the case, adjust the distance between the divided pickup and the string so it's somewhat greater than the recommendation.

### 12. Check the volume balance of all the strings.

Play each of the strings at normal strength; if a string sound unusually loud, lower the sensitivity of that string to minimize any discrepancy in volume between the strings.

### 13. Press the [EXIT] button a number of times to return to the top screen.

These settings are required when you've newly installed a divided pickup on your guitar or bass, or when you've adjusted the height of the divided pickup.

For details on the other parameters, refer to "Reference Manual" (Roland website).

## Adjusting the Volume

Use [OUTPUT LEVEL] knob to adjust the overall volume of the GM-800.

## Using the Tuner

### 1. Press the [MENU] button.

### 2. PAGE [◀] [▶] buttons to access the "TUNER" screen.



### 3. Press the [2] knob.

The TUNER screen appears.



## Making Tuner Settings

To make tuner settings, use the [1], [2] knobs located below the display.

Parameter	Value	Explanation
[1] MASTER TUNE	435–445 Hz	Specifies the reference pitch.
[2] OUTPUT	MUTE	Sound will not be output while tuning.
	BYPASS	While tuning, the sound that's input to the GM-800 will be output without change.
	THRU	Allows you to tune while hearing the current effect sound.

## Playing

### Selecting a Scene

A collection of all part settings, Guitar to MIDI settings, scene effect settings and control function/assign settings is called a "scene".

#### 1. Use the [▲] switch or [▼] switch to select a scene.

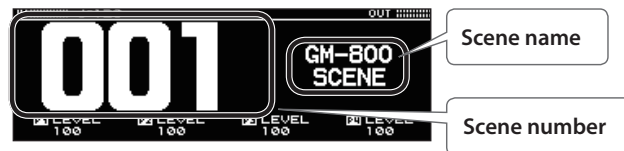

#### MEMO

You can also change scenes by turning the [SELECT] knob below the display.

### About the Play Screen

The screen that appears after you turn on the power is called the "Play screen".

The following four types of play screen are provided; use the PAGE [◀] [▶] buttons to switch between the types of display.

#### Large scene number



#### Large scene name



#### Show the tones selected for each part

PART	SCENE	NAME	LEVEL
1	0001	Acoustic Piano	100
2	0101	Reso Saw Bass	100
3	0201	Funky Reso Lead	100
4	0301	Magic Pad	100

#### Show functions assigned to switches of this unit



### About the Icons



Icon	Explanations
	Indicates the input level.
	Indicates the output level.
	Indicates the BPM.
	Indicates the page to which you navigate using the PAGE [◀] [▶] buttons (edit screen).

#### MEMO

You can change the parameters that are adjusted by knobs [1]–[4] when the play screen is shown.

For details, refer to the "Reference Manual" (Roland website).

# USING THE UNIT SAFELY

## WARNING

### Concerning the Auto Off function

The power to this unit will be turned off automatically after a predetermined amount of time has passed since it was last used for playing music, or its buttons or controls were operated (Auto Off function). If you do not want the power to be turned off automatically, disengage the Auto Off function (p. 4).



### Use only the supplied AC adaptor and the correct voltage

Be sure to use only the AC adaptor supplied with the unit. Also, make sure the line voltage at the installation matches the input voltage specified on the AC adaptor's body. Other AC adaptors may use a different polarity, or be designed for a different voltage, so their use could result in damage, malfunction, or electric shock.



### Use only the supplied power cord

Use only the attached power cord. Also, the supplied power cord must not be used with any other device.



## CAUTION

### Keep small items out of the reach of children

To prevent accidental ingestion of the parts listed below, always keep them out of the reach of small children.

- Included Parts
- Rubber feet (p. 4)



### Handle the ground terminal carefully

If you remove the screw from the ground terminal, be sure to replace it; don't leave it lying around where it could accidentally be swallowed by small children. When refastening the screw, make that it is firmly fastened, so it won't come loose.



# IMPORTANT NOTES

## Power Supply

- Place the AC adaptor so the side with the indicator faces upwards. The indicator will light when you plug the AC adaptor into an AC outlet.

## Placement

- Depending on the material and temperature of the surface on which you place the unit, its rubber feet may discolor or mar the surface.

## Repairs and Data

- Before sending the unit away for repairs, be sure to make a backup of the data stored within it; or you may prefer to write down the needed information. Although we will do our utmost to preserve the data stored in your unit when we carry out repairs, in some cases, such as when the memory section is physically damaged, restoration of the stored content may be impossible. Roland assumes no liability concerning the restoration of any stored content that has been lost.

## Additional Precautions

- Any data stored within the unit can be lost as the result of equipment failure, incorrect operation, etc. To protect yourself against the irretrievable loss of data, be sure to make a backup of the data stored within it; or you may prefer to write down the needed information.
- Roland assumes no liability concerning the restoration of any stored content that has been lost.
- Never strike or apply strong pressure to the display.

## Using External Memories

- Please observe the following precautions when handling external memory devices. Also, make sure to carefully observe all the precautions that were supplied with the external memory device.
  - Do not remove the device while reading/writing is in progress.
  - To prevent damage from static electricity, discharge all static electricity from your person before handling the device.

## Others

- Please be aware that in some countries or regions, it might not be possible to use Roland Cloud at this time.

## Intellectual Property Right

- The copyright of content in this product (the sound waveform data, style data, accompaniment patterns, phrase data, audio loops and image data) is reserved by Roland Corporation.
- Purchasers of this product are permitted to utilize said content (except song data such as Demo Songs) for the creating, performing, recording and distributing original musical works.
- Purchasers of this product are NOT permitted to extract said content in original or modified form, for the purpose of distributing recorded medium of said content or making them available on a computer network.
- ASIO is a trademark and software of Steinberg Media Technologies GmbH.
- This product contains eParts integrated software platform of eSOL Co.,Ltd. eParts is a trademark of eSOL Co., Ltd. in Japan.
- This Product uses the Source Code of  $\mu$ T-Kernel under T-License 2.0 granted by the T-Engine Forum ([www.tron.org](http://www.tron.org)).
- This product is using the open source software from a third party.
  - Copyright © 2009-2018 Arm Limited. All rights reserved. Licensed under the Apache License, Version 2.0 (the "License"); You may obtain a copy of the License at <http://www.apache.org/licenses/LICENSE-2.0>
  - Copyright © 2017 STMicroelectronics. All rights reserved. This software component is licensed by ST under BSD 3-Clause license, the "License"; You may obtain a copy of the License at <https://opensource.org/licenses/BSD-3-Clause>
- Roland and BOSS are either registered trademarks or trademarks of Roland Corporation in the United States and/or other countries.
- Company names and product names appearing in this document are registered trademarks or trademarks of their respective owners.

# Main Specifications

<b>Dimensions</b>	246 (W) x 134 (D) x 63 (H) mm (without rubber foot) 9-11/16 (W) x 5-9/32 (D) x 2-31/64 (H) inches (without rubber foot)
	246 (W) x 134 (D) x 65 (H) mm (including rubber foot) 9-11/16 (W) x 5-9/32 (D) x 2-9/16 (H) inches (including rubber foot)
<b>Weight (excluding AC adaptor)</b>	1.2 kg 2 lbs 9 oz
<b>Accessories</b>	AC adaptor Quick Start Leaflet "USING THE UNIT SAFELY" Rubber foot x 4
<b>Options (sold separately)</b>	Divided pickup: GK-5 (for guitar), GK-5B (for bass guitar) Serial GK cable: BGK-15 (15 ft./4.5 m), BGK-30 (30 ft./9 m) GK converter: GKC-DA, GKC-AD Footswitch: FS-5U, FS-5L, FS-6, FS-7 Expression Pedal: EV-30, FV-500L, FV-500H, Roland EV-5

\* 0 dBu = 0.775 Vrms

\* This document explains the specifications of the product at the time that the document was issued. For the latest information, refer to the Roland website.