

DEXIBELL



VIVO | S10 |

stage piano

Owner's Manual

HANDMADE
IN ITALY

Regulatory and Safety Information

Users in U.S.A

This product has been tested and found to comply with the limits for a Class B digital devices, pursuant to Part 15 of the FCC Rules. These limits are designed to provide reasonable protection against harmful interference in a residential installation. This equipment generates, uses, and can radiate radio frequency energy and, if not installed and used in accordance with the instructions, may cause harmful interference to radio communications. However, there is no guarantee that interference will not occur in a particular installation. If this equipment does cause harmful interference to radio or television reception, which can be determined by turning the equipment off and on, the user is encouraged to try to correct the interference by one or more of the following measures:

- Reorient or relocate the receiving antenna.
- Increase the separation between the equipment and receiver.
- Connect the equipment into an outlet on a circuit different from that to which the receiver is connected.
- Consult the dealer or an experienced radio/TV technician for help.

This device complies with part 15 of the FCC Rules. Operation is subject to the following two conditions:

- 1) This device may not cause harmful interference; and
- 2) This device must accept any interference received, including interference that may cause undesired operation.

FCC CAUTION: Any unauthorized changes or modifications not expressly approved by the party responsible for compliance could void the user's authority to operate the equipment.

NOTE: The manufacturer is not responsible for any radio or tv interference caused by unauthorized modifications to this equipment. Such modifications could void the user's authority to operate the equipment.

Radiation Exposure Statement

This product complies with the US portable RF exposure limit set forth for an uncontrolled environment and is safe for intended operation as described in this manual. Further RF exposure reduction can be achieved if the product is kept as far as possible from the user body or is set to a lower output power if such function is available.

This transmitter must not be co-located or operated in conjunction with any other antenna or transmitter.

Users in Canada

This device complies with Industry Canada's licence-exempt RSSs. Operation is subject to the following two conditions:

- (1) this device may not cause interference, and
- (2) this device must accept any interference, including interference that may cause undesired operation of the device.

Le présent appareil est conforme aux CNR d'Industrie Canada applicables aux appareils radio exempts de licence. L'exploitation est autorisée aux deux conditions suivantes: (1) l'appareil ne doit pas produire de brouillage, et (2) l'utilisateur de l'appareil doit accepter tout brouillage radioélectrique subi, même si le brouillage est susceptible d'en compromettre le fonctionnement.

Radiation Exposure Statement

The product complies with the Canada portable RF exposure limit set forth for an uncontrolled environment and are safe for intended operation as described in this manual. The minimum separation distance for portable use is limited to 15mm assuming use of antenna with 2 dBi of gain. The further RF exposure reduction can be achieved if the product can be kept as far as possible from the user body or set the device to lower output power if such function is available.

Le produit est conforme aux limites d'exposition pour les appareils portables RF pour les Etats-Unis et le Canada établies pour un environnement non contrôlé. La distance de séparation minimale pour l'utilisation portative est limitée à 15mm en supposant l'utilisation de l'antenne avec 2 dBi de gain. Le produit est sûr pour un fonctionnement tel que décrit dans ce manuel. La réduction aux expositions RF peut être augmentée si l'appareil peut être conservé aussi loin que possible du corps de l'utilisateur ou que le dispositif est réglé sur la puissance de sortie la plus faible si une telle fonction est disponible.

Users in EU

This device complies with Industry Canada's licence-exempt RSSs. Operation is subject to the following two conditions:

This device complies with the essential requirements of the 2014/53/EU – Radio Equipment Directive (RED). The following test methods have been applied in order to prove presumption of conformity with the essential requirements of the 2014/53/EU – Radio Equipment Directive (RED):

- EN 62368-1:2014/A11:2017
Safety requirements for audio/video, information, and technology equipment
- EN 300 328 v2.2.2 (2019-07)
Wideband transmission systems; Data transmission equipment operating in the 2,4 GHz band; Harmonized Standard for access to radio spectrum
- EN 62311:2008 | EN 50385:2017
RF exposure
- EN 301 489-1 v2.2.0 (2017-03)
Electromagnetic compatibility and Radio Spectrum Matters (ERM); ElectroMagnetic Compatibility (EMC) standard for radio equipment and services; Part 1: Common technical requirements
- EN 301 489-17 V3.2.0 (2017-03)
Electromagnetic compatibility and Radio spectrum Matters (ERM); ElectroMagnetic Compatibility (EMC) standard for radio equipment and services; Part 17: Specific conditions for 2,4 GHz wideband transmission systems and 5 GHz high performance RLAN equipment
- EN 301 893 v2.1.1 (2017-05)
5 GHz RLAN; Harmonized Standard covering the essential requirements of article 3.2 of Directive 2014/53/EU
- EU 2015/863 (RoHS 3)
Declaration of Compliance – EU Directive 2015/863; Reduction of Hazardous Substances (RoHS)

VIVO | S10 |

stage piano

Owner's Manual

Welcome to the reference manual of the VIVO S10 and congratulations for purchasing this instrument.

VIVO S10 stage piano is the top-class of the VIVO PREMIUM digital piano series. A realism never heard before, thanks to the latest technology managed of a most powerful processor equipped with 3.2 GB size of memory for sounds.

*All sounds was recorded with **holophonic** method for an amazing 3D listening experience and reproduced using the new technology called **T2L (True to Life)**, based on interaction between Sampling and Modelling methods. Moreover, the sound quality has been raised-up to **24 bit - 48KHz** with an average of 5 times longer ever recorded samples (15" on lower piano notes).*

*The realistic **88 keys hammer action keyboard**(enhanced with real wood parts) contributes to simulate the realistic responsiveness of a real acoustic piano.*

A dedicated sections with powerful real-time controls give you maximum expression on stage.

*The **organ section with nine motorised draw-faders** and many effects as rotary , percussion, vibrato, chorus, allows you to enjoy full-fledged organ sounds in your performances. Furthermore, the sound section allows you to select the best selection of Pianos, Brass, Synths sounds with undeniable Dexibell sound quality.*

All this and more makes the **VIVO S10** the ideal all-in one solution for performing keyboard players.

To ensure that you obtain the maximum enjoyment and take full advantage of the organ functionality, please read all sections of this owner's manual carefully.

Keep this manual handy for future reference.



Start to take advantage of valuable benefits available simply registering your product on www.dexibell.com.

- You can benefit of DEXIBELL's **3 years** extended warranty (*The extended warranty is subject to terms and conditions. Please refer to the related section*).
- Keeps you updated on special offers.
- You can be updated on any new software release and new sounds.

For European countries



	<p>This Symbol indicates that in EU countries, this product must be collected separately from household waste, as defined in each region. Products bearing this Symbol must not be discarded together with household waste.</p>		<p>Tento symbol vyjadruje, že v krajinách EÚ sa musí zber tohto produktu vykonávať oddelene od domového odpadu, podľa nariadení platných v konkrétnej krajine. Produkty s týmto symbolom sa nesmú vyhazovať spolu s domovým odpadom.</p>
	<p>Questo simbolo indica che nei paesi della Comunità europea questo prodotto deve essere smaltito separatamente dai normali rifiuti domestici, secondo la legislazione in vigore in ciascun paese. I prodotti che riportano questo simbolo non devono essere smaltiti insieme ai rifiuti domestici. Ai sensi dell'art. 13 del D.Lgs. 25 luglio 2005 n. 151.</p>		<p>Ez a szimbólum azt jelenti, hogy az Európai Unióban ezt a terméket a háztartási hulladéktól elkülönítve, az adott régióban érvényes szabályozás szerint kell gyűjteni. Az ezzel a szimbólummal ellátott termékeket nem szabad a háztartási hulladék közé dobni.</p>
	<p>Ce symbole indique que dans les pays de l'Union européenne, ce produit doit être collecté séparément des ordures ménagères selon les directives en vigueur dans chacun de ces pays. Les produits portant ce symbole ne doivent pas être mis au rebut avec les ordures ménagères.</p>		<p>Tämä merkintä ilmaisee, että tuote on EU-maissa kerättävä erillään kotitalousjätteistä kunkin alueen voimassa olevien määräysten mukaisesti. Tällä merkinnällä varustettuja tuotteita ei saa hävittää kotitalousjätteiden mukana.</p>
	<p>Dieses Symbol bedeutet, dass dieses Produkt in EU-Ländern getrennt vom Hausmüll gesammelt werden muss gemäß den regionalen Bestimmungen. Mit diesem Symbol gekennzeichnete Produkte dürfen nicht zusammen mit den Hausmüll entsorgt werden.</p>		<p>Το σύμβολο αυτό υποδηλώνει ότι στις χώρες της Ε.Ε. το συγκεκριμένο προϊόν πρέπει να συλλέγεται χωριστά από τα υπόλοιπα οικιακά απορρίμματα, σύμφωνα με όσα προβλέπονται σε κάθε περιοχή. Τα προϊόντα που φέρουν το συγκεκριμένο σύμβολο δεν πρέπει να απορρίπτονται μαζί με τα οικιακά απορρίμματα.</p>
	<p>Este símbolo indica que en los países de la Unión Europea este producto debe recogerse aparte de los residuos domésticos, tal como está regulado en cada zona. Los productos con este símbolo no se deben depositar con los residuos domésticos.</p>		<p>See sümbol näitab, et EL-i maades tuleb see toode olemprügist eraldi koguda, nii nagu on igas piirkonnas määratletud. Selle sümboliga märgitud tooteid ei tohi ära visata koos olmeprügiga.</p>
	<p>Dit symbool geeft aan dat in landen van de EU dit product gescheiden van huishoudelijk afval moet worden aangeboden, zoals bepaald per gemeente of regio. Producten die van dit symbool zijn voorzien, mogen niet samen met huishoudelijk afval worden verwijderd.</p>		<p>Ta simbol označuje, daje treba proizvod v državah EU zbirati ločeno od gospodinjiskih odpadkov, tako kot je določeno v vsaki regiji. Proizvoda s tem znakom ni dovoljeno odlagati skupaj z gospodinjiskimi odpadki.</p>
	<p>Este símbolo indica que nos países da UE, a recolha deste produto deverá ser feita separadamente do lixo doméstico, de acordo com os regulamentos de cada região. Os produtos que apresentem este símbolo não deverão ser eliminados juntamente com o lixo doméstico.</p>		<p>Šis simbols norāda, ka ES valstīs šo produktu jāievāc atsevišķi no mājsaimniecības atkritumiem, kā noteikts katrā reģionā. Profuktus ar šo simbolu nedrīkst izmest kopā ar mājsaimniecības atkritumiem.</p>
	<p>Dette symbol angiver, at i EU-lande skal dette produkt opsamles adskilt ffa husholdningsaffald, som defineret i hver enkelt region. Produkter med dette symbol må ikke smides ud sammen med husholdningsaffald.</p>		<p>Šis simbolis rodo, kad ES šalyse šis produktas turi būti surenkamas atskirai nuo buitinių atliekų, kaip nustatyta kiekviename regione. Šiuo simboliu paženklininti produktai neturi būti išmetami kaitų su buitiniemis atliekomis.</p>
	<p>Dette symbolet indikerer at produktet må behandles som spesialavfall i EU-land, iht. til retningslinjer for den enkelte regionen, og ikke kastes sammen med vanlig husholdningsavfall. Produkter som er merket med dette symbolet, må ikke kastes sammen med vanlig husholdningsavfall.</p>		<p>Symbolen anger att i EU-länder måste den här produkten kasseras separat från hushållsavfall, i enlighet med varje regions bestämmelser. Produkter med den här symbolen får inte kasseras tillsammans med hushållsavfall.</p>
	<p>Symbol oznacza, że zgodnie z regulacjami w odpowiednim regionie, w krajach UE produktu nie należy wyrzucać z odpadami domowymi. Produktów opatrzonych tym symbolem nie można utylizować razem z odpadami domowymi.</p>		<p>Tento symbol udává, že v zemích EU musí být tento výrobek sbírán odděleně od domácího odpadu, jak je určeno pro každý region. Výrobky nesoucí tento symbol se nesmí vyhazovat spolu s domácím odpadem.</p>

1 Important Safety Instructions

PLEASE READ CAREFULLY BEFORE PROCEEDING



WARNING

Always follow the following precaution listed below to avoid user to the risk of serious injury or even death from electrical shock, fire or other hazard.

Only use non-tropical weather

This unit and its AC adaptor can only be safely used in non-tropical weather. The operating temperature range is 5° - 40°C (41° - 104°F).



Do not repair, modify or replace parts by yourself

Do not attempt to repair the unit, modify or replace parts of the product. Please contact all the nearest Dexibell Service Center.



Do not disassemble or modify by yourself

Do not open the unit or its AC adaptor or attempt to disassemble or modify the internal component in any way.



Use only the supplied AC adaptor (DEXIBELL DYS602-240250W or DEXIBELL DYS865-240250W).

Use only the AC adaptor included with the unit. Connecting a different AC adaptor can cause serious damage to the internal circuitry and may even pose a shock hazard.



Use only the supplied power cord

Use only the AC power cord supplied with the AC adaptor included in the package.



Do not excessively bend the power cord

Do not excessively twist or bend the power cord otherwise you damage it. Damaged cords may cause fire and shock hazards!



Do not place the unit in an unstable location

Do not place the unit in a unstable position where it might accidentally fall over.



Take care not to allow liquid or foreign objects to enter unit; Do not place containers with liquid on unit

Do not place object filled with liquid (glass of water on this product. Never allow foreign objects (e.g., flammable objects, coins, wires) or liquids (e.g., water or juice) to enter this product. Doing so may cause short circuits, faulty operation, or other malfunctions.



Never place or store the product in the following types of locations

- Exposed to extreme cold or heat (such as in direct sunlight, near a heater, or in a car during the day).
- Subject to steam or smoke.
- Damp (such washroom, baths, on wet floors).
- Subject to salt water exposure.
- Exposed to rain.
- Dusty or sandy.
- Subject to extreme changes of temperature or humidity (The condensation may occur and water may collect on the surface of the instrument. Wooden parts may absorb water and be damaged).
- Subject to high levels of vibration and shakiness.



Do not drop the unit or subject it to strong impact

Do not drop the unit. Protect it from strong impact!



Do not connect the unit to an outlet with an unreasonable number of other devices

Do not connect the unit's power-supply cord to an electrical outlet with an unreasonable number of other devices. This could cause the outlet to overheat and possibly cause a fire.



Adults must provide supervision in places where children are present

When using the unit in locations where children are present, never leave the unit unattended. Keep a special watch over any children so that they don't mishandling of the unit can take place.



Avoid extended use at high volume

This unit, either alone or in combination with an amplifier and headphones or speakers, may be capable of producing sound levels that could cause permanent hearing loss. DO NOT operate for a long period of time at a high volume level, or at a level that is uncomfortable. If you experience any hearing loss or ringing in the ears, you should immediately stop using the unit, and consult an audiologist.



If you notice any abnormality turn off the unit immediately

Turn off the unit and remove the AC adaptor from the outlet when:

- If the AC adaptor, the power-supply cord, or the plug has been damaged.
- If smoke or unusual smells occurs.
- If the product has been exposed to rain.
- If objects have fallen into, or liquid has been spilled into the unit.
- If the unit does not operate or exhibits a marked change in performance.
- If the unit has been dropped, or the enclosure of the product has been damaged.



Contact the nearest qualified Service Center.



CAUTION

Always follow the following precaution listed below to avoid user to the risk of serious injury or even death from electrical shock, fire or other hazard .

Grasp the plug connecting or disconnecting the AC adaptor

When removing the electric plug from the instrument or an outlet, always hold the plug itself and not the cord. Pulling by the cord can damage it.



Do not use wet hands to connect or disconnect AC adaptor

Never handle the AC adaptor or its plugs with wet hands when plugging into, or unplugging from, an electrical outlet.



Keep clean the AC adaptor's plug

At regular intervals, unplug the AC adaptor and using a dry cloth clean the adaptor's plug.

If the unit will be unused for an extended period of time, unplug the AC power cord from the AC outlet.



Keep cables from getting entangled

Try to prevent cords and cables from becoming entangled. Place all cords and cables away from children.



Before cleaning the unit, unplug the AC adaptor from the outlet

To avoid electric shock or damage the unit, before cleaning the unit, turn it off and unplug the AC adaptor from the outlet (p. 21).



If there is a possibility of lightning strike in your area, disconnect the AC adaptor from the outlet

If you know a thunderstorm is predicted in your area, disconnect the AC adaptor from the outlet.



Do not rest your weight on or place heavy objects on the unit

Avoid to climb on top of, nor place heavy objects on the unit.



Cautions when moving this unit

- The unit should be handled carefully, all the while keeping it level.
- Disconnect the power cord and all connected cables.



Place in a well ventilated location

The unit and the AC adaptor should be located so their location or position does not interfere with their proper ventilation.



Do not use in tropical climates

Use the unit and the AC adaptor only in a moderate climates (not in tropical climates).



Place near the socket outlet

This equipment should be installed near the socket outlet and disconnection of the device should be easily accessible.



2 Relevant Indications

In addition to the items listed under "Important Safety Instructions" on p. 5, please read and observe the following:



Power supply related

- Do not plug this unit into the same electrical outlet used same by an electrical appliance that is controlled by an inverter or a motor (such as a refrigerator, washing machine or air conditioner). Doing so, can result an audible noise.
- The power adapter may become warm after long hours of consecutive use. It can be a normal dissipation of heat through the adapter casing. To reduce the possibility of overheating place the power adapter on the floor in a well-ventilated location.
- Before connecting the unit to other equipment, turn off the power to all equipment. Otherwise, electrical shock or damage to the equipment may occur.
- If the unit is not operative for 120 minutes (2 hours), to prevent unnecessary power consumption, this unit features an "AUTO OFF" function that automatically turns the unit off. If you don't want the unit to turn off automatically, change the "AUTO OFF" setting to "OFF" as described on p. 77.

NOTE

The "AUTO OFF" setting is memorized when you switch off the unit.



Maintenance related

- To clean the unit, put a soft cloth in lukewarm water, squeeze it well, then wipe the entire surface using an equal amount of strength. Rubbing too hard in the same area can damage the finish.
- Dust should be removed using a soft feather or wool-type duster. Care should be taken not to apply pressure to the finish or to drag the dust across the finish, which can create fine scratches in the surface. Fingerprints or similar marks can be cleaned with a dampened soft cloth, followed by a dry cloth. In cases of stubborn greasy dirt, using a small amount of mild detergent (such as mild dishwashing liquid) on the damp cloth may help. Do not use any cleaners or detergents, since they might deteriorate the surface of the cabinet, and produce cracks. Do not use dusting cloths that contain chemicals.
- Do not wipe this unit with benzene, alcohol or solvent of any kind. Doing so may result in discoloration and/or deformation of the unit.



Related to appropriate location

- Do not place the unit near power amplifiers (or other equipment containing large power transformers) to avoid induced hum. In case of hum, to reduce the problem, change the orientation of your unit or place it away from the source of interference.
- Do not use this unit in the vicinity of a TV or radio. This unit may interfere with radio and television reception.
- When using this unit along with application on your iPhone/iPad, we recommend that you set "Airplane Mode" to "ON" on your iPhone/iPad in order to avoid noise caused by communication.
- Noise may be produced if cell phones are operated in the vicinity of this unit. In case of noise you should relocate such wireless devices so they are at a greater distance from this unit, or switch them off.
- Do not expose the unit to extreme cold or heat, to direct sunlight or near devices that radiate heat. Do not leave the unit inside a vehicle during the day. Extreme temperature can damage the unit.
- Take care when move the unit from one location to another with drastic changes in ambient temperature. Condensation can occur in the unit due to drastic change of temperature. Using the device while condensation is present can cause damage. If there is reason to believe that condensation might have occurred, leave the device for several hours until the condensation has completely dried out.
- Do not place, for long periods of time, vinyl, plastic or rubber objects on this unit. Such objects can discolor or otherwise harmfully affect the finish.
- Do not place objects for long period of time on top of the keyboard. This can be the cause of malfunction of the keys of the keyboard.
- Do not apply any stickers, decals or self-adhesive material to this unit. The glue is difficult to remove and solvents are damaging the exterior finish.
- Do not place object filled with liquid (glass of water on this unit. Avoid to use alcohol, perfume, hairspray, nail polish, etc., near the unit. In the event of liquid spill on the unit, swiftly wipe away the surface using a dry, soft cloth.



Related to repairs

- Always back up your data on a USB memories before you send this unit for repair to an authorized center. All data contained in the unit's memory may be lost. Important data should always be backed up, or written down on paper (when possible). Dexibell assumes no liability concerning such loss of data.



Related to external memories

- Insert the USB Memory (commercially available) into the slot with care and at the correct angle.
- Take particular care when handling USB Memory:
 - Always ground yourself to something metal before handling an USB Memory.
 - Do not touch the pins of the USB Memory connector, or allow them to become dirty.
 - Do not subject the USB Memory to temperature extremes (e.g., direct sunlight in an enclosed vehicle)-
 - Do not allow the USB Memory to become wet-
 - Do not drop or subject it to excessive shock or vibration.
- Do not disconnect the USB Memory while writing and reading data (i.e., while the USB Memory indicator blinks).
- Never use USB hub to connect USB Memory to the unit.
- This unit allows you to use commercially available USB Memory. You can purchase such devices at a computer store, a digital camera dealer, etc.
- The audio recording require a USB storage device to support high sustained transfer rates. Not all USB devices will guarantee flawless performance.



Other precautions

- The contents of memory could be lost due to malfunction or improper operation. To help prevent the loss of your data, we highly recommend that you periodically save a backup copy of important data you have stored in the unit's memory on another storage device. (e.g., USB memories).
- Unfortunately, an error may occur during the data restore previously stored in the USB memories. Dexibell shall not be liable for loss of profits or any consequential loss, loss of data.
- Do not use excessive force when handling unit's buttons, switches, sliders and controls and when use connectors and jacks. Rough handling can cause damage o malfunctions.
- Always pull by the connector when disconnecting a cable, never pull the cable Not doing so you will cause shorts, or damage to the cable's internal elements.
- Keep the unit's volume levels down. The instrument should be used at a reasonable volume, to avoid disturbing neighbours, especially at night and in the early morning. Use headphones if you want to play your music loud or late at night.
- When you need to transport the unit, put it in its original packaging with padding in the box. Otherwise, you will need to use equivalent packaging materials. When transporting or moving the unit always use two or more people.
- To prevent possible damage, avoid applying excessive force to the music stand.
- For connecting this unit use cable low impedance cables. The use of cables that contain resistor can cause the sound level to be extremely low, or impossible to hear.



Related to copyright and trademarks

- Dexibell do not assume legal liability regarding any infringements of the user through the use of this unit.
- Recording, copying, distribution of copyrighted material (songs, live performance, etc.) belonging to a third party in part or in whole without the permission of the copyright owner is forbidden by law.
- iPad® and iPhone® are registered trademarks of Apple Inc.
- App Store™ is an Apple's Service Mark.
- The **Bluetooth**® word mark and logos are registered trademarks owned by Bluetooth SIG, Inc. and any use of such marks by PROEL is under license.

Conventions Used in This Manual

The following symbols are used.

- NOTE** It indicates an important note; be sure to read it.
- MEMO** It indicates a memo regarding the setting or function; It's up to you read it.
- TIPS** It indicates a useful hint for operation; read it as necessary.

Contents

Important Safety Instructions	5
Relevant Indications	7
Panel Description	10
Connections Quick Guide	13
Quick Guide	14
Before You Start to Play	17
Connecting the AC Adaptor	17
Connecting External Audio Amplifier	17
Connecting the Pedals	17
Listening Through Headphones	18
Connecting Digital Player Devices	18
Connecting the VIVO S10 to Your Computer	18
Connecting the VIVO S10 to an USB MIDI Keyboard (USB host function)	19
Connecting the VIVO S10 to MIDI devices	19
Connecting an USB Memory (commercially available)	19
How to Format the USB Memory	20
Safely Remove the USB Memory	20
Installing Music Rest	20
Ground Terminal	20
Turning the Power On	20
Turning the Power Off	21
Demo of the VIVO S10	21
Basic Operation	22
About the Display and Cursor Operation	22
Main Page	22
Moving the Cursor and Setting Parameter Values	23
Assigning the Name You Specify	23
Selecting Tones	24
Grand Piano Mode	24
How to Customize and Save Your Grand Piano Mode Configuration	24
How to Select a Part	24
How to Select Tones	24
Most Frequently Used Tones (Favorite Tone)	25
Playing Two Sounds Over the Entire keyboard (Layer)	25
Splitting the Keyboard Range and Playing Two Different Tones (LOWER)	26
Adding the PEDAL Part	26
Special Pedalboard Tones: "Pedal Bass" and "Pedal DoubleBs"	26
Play All Parts in Layer Mode	26
How to change the Split Point	27
Adjust the Volume and Reverb for Each Part by the Draw Faders	27
How to Reorder the Tone List	27
Tone MIDI Information	28
Organ Section	29
Selecting Various Organ Types	29
Selecting Presetted Organ Sounds	29
Motorised Draw-faders	30
Altering the Sound using Draw-faders	30
Assigning the Draw-faders (TW ASSIGN)	30
Useful Draw-faders Movement Functions (Morphing)	30
Applying Vibrato/Chorus Effect	31
Adding Overdrive Effect	31
Editing Overdrive Parameter	32
Adding Harmonic Percussion	32
Adding Rotary Effect	32
Adding Effects to Orchestral Sound	33
Going Around Sound Effects	33
FX Real-time Controls	33
Selecting a Sound Effect	33
Adding Reverb to the Sound	34
Adjust the Reverb for Each Part by the Draw Faders	34
Other Functions	35
Transposing the pitch of the keyboard	35
Shifting the Tuning of a Keyboard Part in Octave Steps	35
Aftertouch	35
Assigning a function	35
Performing Musical Chords	36
Chord Enhancer	36
Chord Freeze	36
Adjusting the Keyboard Response (Key Touch)	36
Customize the Global Keyboard Response (Key Touch)	36
Adjusting the AUDIO IN Input Level	37
Specifying the Audio Output for Each Part	37
Restoring the Factory Settings (Factory Reset)	38
Restore the Factory Sounds	38
How to Protect Your Settings, Contents and Sounds List (Backup)	38
Backup Your Settings, Contents and Sounds List	38
Restore Your Settings, Contents and Sounds List	38
Panic Function	39
Additional Sound (Sound Library)	40
Remove and Add Sound Libraries	40
Removing a Sound Library	41
How To Load Sound Libraries in a USB Memory	41

Adding a Library	41
How to Select USER Sounds	42
How to Select USER Organ Sounds	43
How to Select USER Orchestral Sounds	43
Sound Setup (Export/Import)	44
Exporting a Sound Set ("EXPORT SETUP")	44
Importing a Sound Set ("IMPORT SETUP")	44
Personalizing Your Sounds (T2L)	45
Making Slight Additions or Sound Alterations	45
Parameters to be edited	45
Orchestral Sounds Parameters	46
TW Organ Sound Parameters	47
Adjusting the Keyboard Velocity Response According to the Sound	49
Working with the Memories	50
About the Memories and Memory Set structure	50
Saving Your Settings in the Internal Memory	50
Recalling your Settings from Internal Memory	50
How to Rearrange the Order of Memories	50
Saving Your Settings in the USB Memory (commercially available)	51
Recalling your settings from an USB Memory	52
Renaming a Memory	53
Exporting a Memory Set in the USB Memory	53
Importing a Memory Set from the USB Memory	53
Deleting a Memory Set	54
How to Automatically Recall Your Favorite Setting at the Power On	54
How to Customize the Grand Piano Mode	54
Playing a Music Audio File	55
Before Playing Songs	55
Copying Audio Files to an USB Memory	55
Selecting and Playing a Song	55
Useful Song Controls	56
How to Rename or Remove Songs on a USB Memory (Song Explorer)	56
Recording Your Performance	58
Recording Your Music as Audio Data (WAVE)	58
How to Record your Performance over an Existing Audio Song (Overdub)	58
Master Keyboard Zone	59
Programmable Four MIDI zones	59
Configure the MIDI zones	59
Playing with Audio Backing Tracks	61
Connecting your Mobile Device	61
Playing with X MURE Application	61
Wireless Function	62
Bluetooth® Audio and MIDI Connectivity	62
Turning on the VIVO S10's Bluetooth® Functions	62
Connecting with the Mobile Device	62
Connecting an Already Paired Mobile Device	63
Using Bluetooth® Audio	63
Transferring Bluetooth® MIDI Data	63
Master Equalizer	65
Real Time Control	65
Master Equalizer Adjusting	65
Master Equalizer Preset	65
Saving Your User Preset	66
MENU Options (Advanced Section)	67
General procedure	67
SETTING Parameters Group	68
T2L EDITOR	69
EFFECTS	69
OUTPUT	69
MIDI ZONE (A, B, C, D)	69
CONTROL	70
TUNING	72
MEMORY	74
USB MEMORY	74
USB AUDIO	74
AUDIO INPUT	74
BLUETOOTH	74
MIDI	75
GLOBAL	77
SOUND LIBRARY	78
SOUND SETUP	78
SOUND LIST	78
FACTORY RESET	78
FACTORY SOUND	78
BACKUP	78
PANIC	78
VERSION INFO	78
Appendix	79
Effects Types and Parameters List	79
VIVO S10's Tone List	82
VIVO S10's Organ Preset List	83
Draw-faders MIDI Controls	84
Troubleshooting	85
Specifications	86
Index	87

3 Panel Description

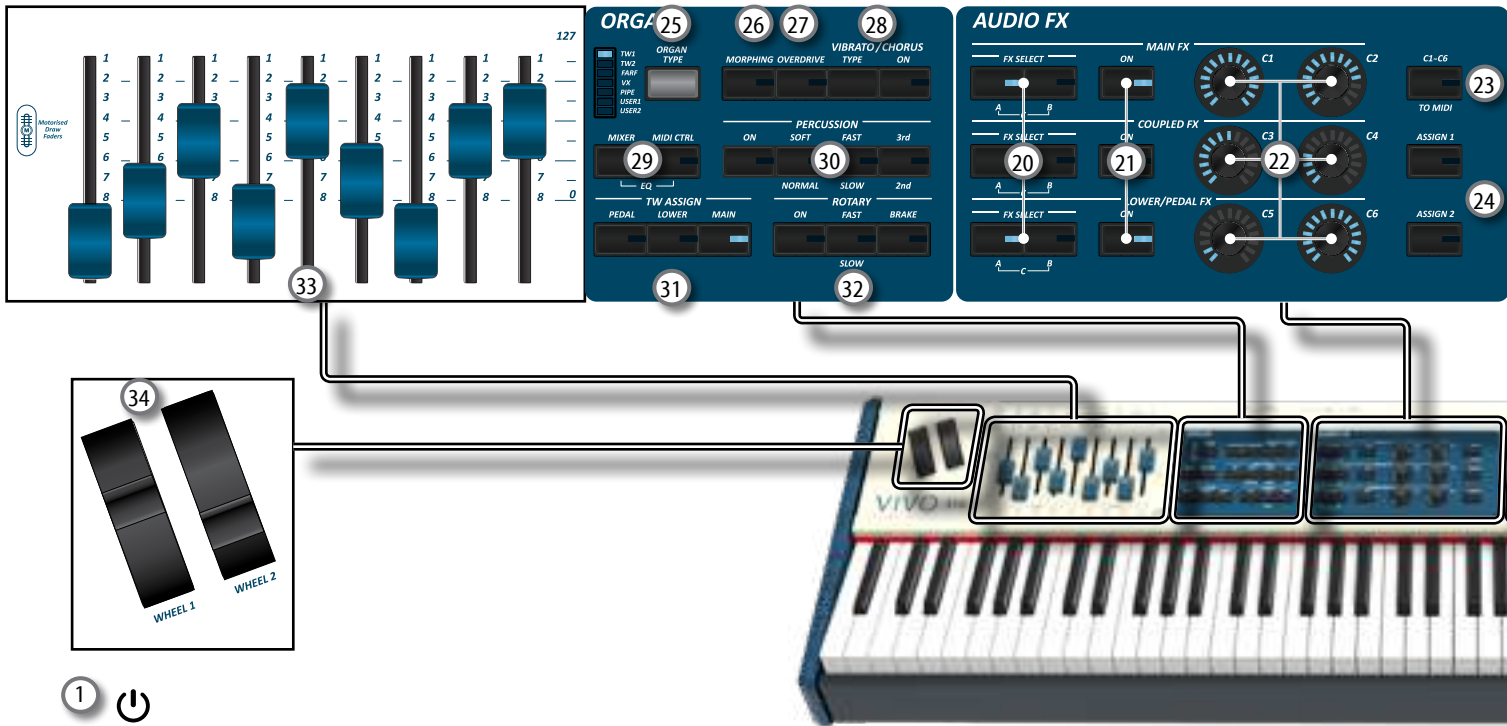

1

Turns the power on or off (p. 20).

With the factory settings VIVO S10's power will automatically be switched off 120 minutes after you stop playing or operating the VIVO S10.

If VIVO S10's power has been turned off automatically, you can use the switch to turn the VIVO S10 back on. If you don't want the power to turn off automatically, set the "AUTO OFF" parameter to "OFF" (p. 77).

NOTE

To avoid malfunctions, never disconnect the AC/DC adapter while the instrument is turned on.

2 **VOLUME**

Use this knob to set VIVO S10's overall volume.

3 **SOUND LIBRARY**

Press this button to access the Sound Libraries environment.

4 **CHORD ENHANCER and CHORD FREEZE**

The [ENHANCER] button enable the Enhancer function. This function improve the sound adding notes to the played chord. See "Performing Musical Chords" (p. 36). The [FREEZE] button to enable the Freeze function and memorize the chord played in the keyboard in that moment. From now on and until the function is active, whenever you press a note in the keyboard the chord memorized will be reproduced with the same tonality of the played note. For details see p. 32.

NOTE

The Chord Enhancer function works when a not percussive tone is selected. See the sounds table "VIVO S10's Tone List" (p. 82).

5 **PLAYER section**

Press the [SONG] button to switch in Song Mode. See p. 55. Press it together with the button to listen the demo song. Press the button to start playing. Press it again to stop playing (See p. 61). Press the button to start recording of your song (See p. 58).

6 **OCTAVE**

This button calls up the octave function. See p. 35.

7 **TRANPOSE**

This button calls up the transposition function. See p. 35. If the button indicator doesn't light the instrument use its normal pitch.

8 **AFTERTOUCH**

Press this button to enable the aftertouch function. This function lets you modify the sound by applying additional pressure to the key. Press and hold this button to open the Aftertouch page and edit the parameters. See p. 35.

9 **SOUND**

When this button is active (it's lit), you can select sounds by the bank and number buttons.

10 **MEMORY/WRITE**

When this button is active (it's lit), you can select memories by the bank (Family Tone buttons) and number buttons. Press and hold this button to write a memory. See p. 50.

11 **BANK/NUMBER buttons**

These buttons allow you to select sounds and memories. When the [SOUND] button is active (it's lit), the first row select the sounds families and the second row select the sound number. See p. "How to Select Tones" (p. 24).

When the [MEMORY] button is active (it's lit), the first row select the bank of memories and the second row select the number. See "Working with the Memories" (p. 50).

12 **Keyboard Mode Section**

Use the [PEDAL] and the [LOWER] buttons to split the keyboard and to play the relative part with your left hand. Use the [MAIN] button to select the Main part. Use the [COUPLED] button to add the coupled part.

13 **MASTER KEYBOARD ZONE (A, B, C, D)**

These buttons allows you to manage the Master Keyboard Zone functions. See p. 59.

Press and hold one of the buttons to access the edit page.

14 **T2L**

Press this button to open the T2L page and personalize the tones of the instrument.

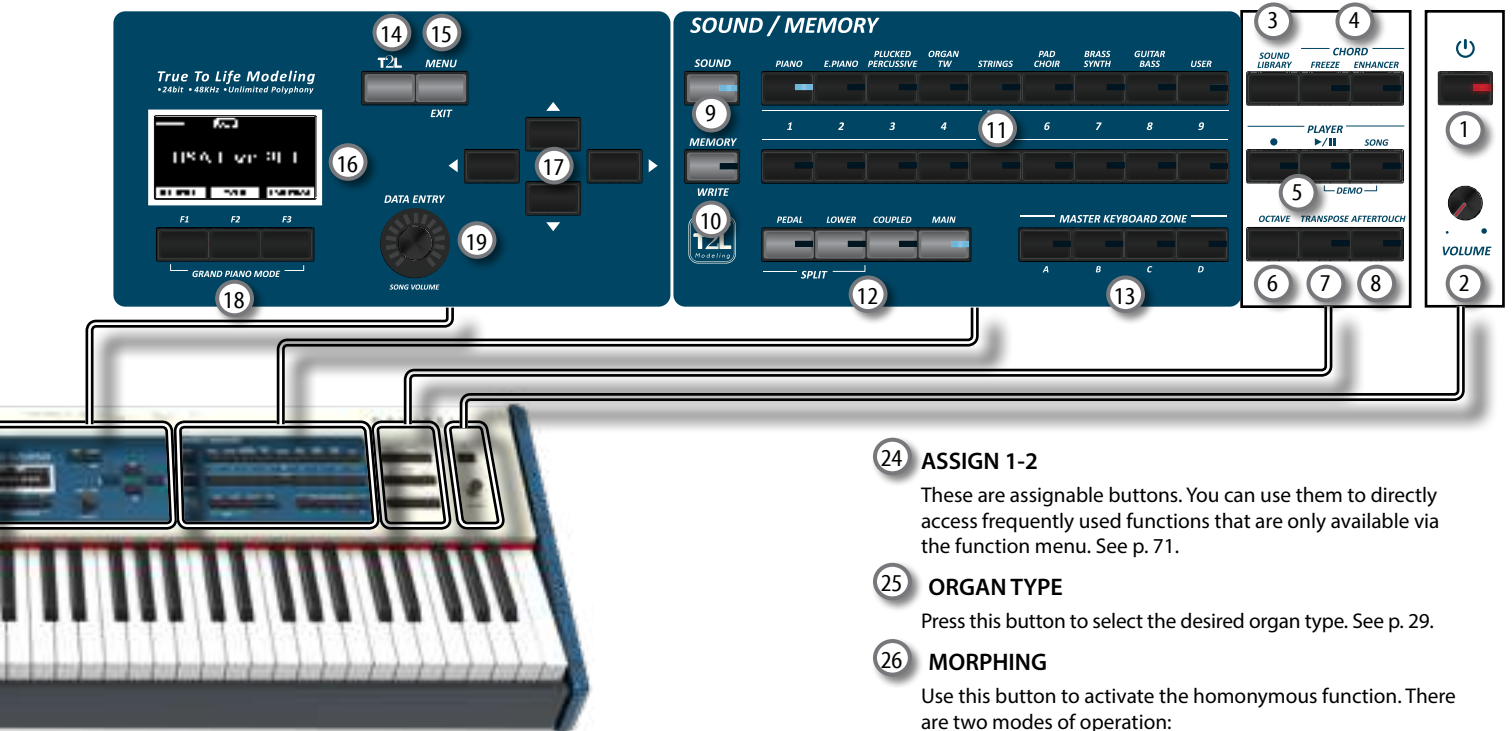

15 MENU/EXIT

This button allows you to open and close the menu page where you can view and select all available functions.

16 DISPLAY

This display shows information related to your operation. The last row of the display shows the functions that you can recall pressing one of three function button (F1, F2, F3) below the display.

17 Arrow buttons

These buttons are used to navigate around the various menus, adjust the parameters value.

18 Function buttons (F1, F2, F3)

These buttons are used to select one of three functions/options shows at the bottom of the display.

19 DATA ENTRY/SONG VOLUME

When a parameter is selected this knob works as Data Entry. When the instrument is in song mode this knob allows you to set the volume of the song player.

20 FX SELECT A/B (Main FX Coupled FX, Lower/Pedal FX)

Use the buttons [FX SELECT A] and [FX SELECT B] to select which AUDIO FX processor (A, B or C) you want to control for the Main, Coupled and Lower/Pedal part. To select the AUDIO FX C processor, press the buttons [A] and [B] at the same time. The [ON] buttons and the (C1-C2, C3-C4, C5-C6) control knobs are assigned to the AUDIO FX processor selected (A, B or C).

21 ON (Main FX, Coupled FX, Lower/Pedal FX)

Use these buttons to switch ON/OFF the AUDIO FX processors for the relative parts (Main, Coupled and Lower/Pedal). Use the [FX SELECT A] and/or the [FX SELECT B] buttons to select the AUDIO FX processor you want to control (A, B or C).

22 C1-C2, C3-C4, C5-C6 control knobs

Use these control knobs to adjust the parameter value of the effect related to the current tone. Use the [FX SELECT A] and/or the [FX SELECT B] buttons to select the AUDIO FX processor you want to control (A, B or C).

23 C1~C6 / TO MIDI

This button allows you to enable the control knobs C1~C6 to send MIDI messages to control external MIDI devices.

24 ASSIGN 1-2

These are assignable buttons. You can use them to directly access frequently used functions that are only available via the function menu. See p. 71.

25 ORGAN TYPE

Press this button to select the desired organ type. See p. 29.

26 MORPHING

Use this button to activate the homonymous function. There are two modes of operation:

- **AUTO** - When you recall a tonewheel, the position of the draw-faders is not achieved immediately, but within a specific time. See p. 30.
- **PEDAL** - The transition between two different combinations of draw-faders (FROM, TO) is performed by the movement of the expression pedal connected to the ASSIGN 3 (morphing) socket. See p. 30.

27 OVERDRIVE

Press this button to active a natural-sounding distortion typical of a vacuum tube amplifier. You can modify some parameters related to this effect. See p. 31.

28 VIBRATO/CHORUS section

Use this section to adjust the vibrato and chorus effect.

Press [TYPE] to select the type of effect.

Press [ON] button to enable or disable the effect.

29 MIXER, MIDI CTRL

Use these button to selects the groups of parameters (Mixer, MIDI or EQ) that is controlled by the 9 draw faders.

By pressing these two buttons simultaneously, you can control the EQ parameters.

30 PERCUSSION section

Use this section to add the classic crisp attack unique to the vintage organ. See p. 32.

31 TW ASSIGN section

Here you can select which part (PEDAL/LOWER/MAIN) is assigned to the draw-faders. This selection is useful while editing or playing live.

32 ROTARY section

Use this section to simulate the sound of classic rotary speakers from the past. See p. 32.

33 Motorised Draw-faders

The 9 draw-faders are used to adjust the volume of each footage. Each draw-fader is labelled with the numbers 1 - 8 along the flat part of the draw-fader. When recalling a presetted tonewheel or a memory, the draw-faders physically will move to reach the new position. See p. 30.

34 WHEEL 1, WHEEL 2

Move these wheel forward or backward to modify the value of the assigned parameter. At default the WHEEL 1 is assigned to the Pitch and the WHEEL2 to the Modulation. To assign another parameter to these controllers see p. 71.

Rear Side

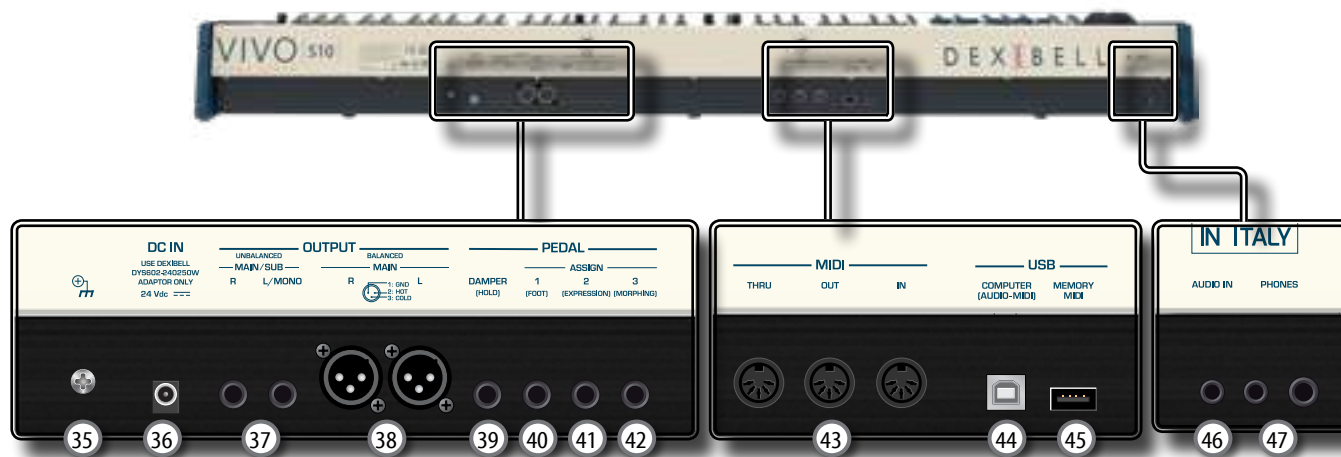

35 Ground terminal

Depending on the circumstances of a particular setup, you could feel a tingling sensation at the point where you touch this device.

You can eliminate this sensation connecting the ground terminal with an external ground. For details see p. 20.

36 DC IN socket

Connect the supplied AC/DC adaptor here (p. 17).

NOTE

Be sure to use only the AC adaptor (DEXIBELL DYS602-240250W or DEXIBELL DYS865-240250W) supplied with the unit. Also, make sure the line voltage at the installation matches the input voltage specified on the AC adaptor body. Other AC adaptors may use a different polarity, or be designed for a different voltage, so their use could result in damage, malfunction, or electric shock.

37 UNBALANCED MAIN/SUB OUTPUT R, L/MONO sockets

These TS sockets allow you to connect powered speakers or amp (p. 17). All parts of the instrument can be routed to the different outputs (MAIN or SUB) as desired. You can set this output as MAIN (default) or SUB. For details see "Specifying the Audio Output for Each Part" (p. 37).

38 BALANCED OUTPUT R, L sockets

These XLR sockets allow you to connect mixer, powered speakers or amp (p. 17). This output is always works as MAIN.

39 DAMPER (HOLD) pedal

Use this pedal to sustain the sound (p. 17).

NOTE

We suggest to connect at this socket a continuous pedal controller. In this way you can appreciate all the musical nuances of a continuous controller.

40 ASSIGN 1 [FOOT] pedal

Connecting an optional foot switch to this socket allows you to control an assignable function by foot. See p. 17

41 ASSIGN 2 [EXPRESSION] pedal

Connecting a commercially available pedal to this socket allows you to control an assignable function by foot (p. 70).

This socket automatically recognize an expression pedal connected setting the Expression function, regardless of the current function assigned.

42 ASSIGN 3 [MORPHING] pedal

Connecting a commercially available pedal to this socket allows you to control an assignable function by foot (p. 70).

At default, you can use this pedal to drive the transitions between two different combinations of draw-faders (MORPHING). See p. 17.

43 MIDI THRU/OUT/IN sockets

These sockets allow you to connect the VIVO S10 to external MIDI devices to transmit and receive MIDI messages. See p. 19.

The IN socket allows you to connect a commercial available pedal unit so as to play the pedal section with your feet. If you connect a pedal unit here, the PEDAL section becomes polyphonic.

44 USB Computer Port

Use an A→B-type USB cable to connect the VIVO S10 to your computer via this connector p. 18. You'll be able to use your AUDIO/MIDI DAW software to record and play audio data.

The VIVO S10 can transmit/receive MIDI messages and audio streaming at 24 bit 48 KHz.

45 USB Memory Port

Connect an commercially available USB Memory here.

If you connect to this port an USB MIDI keyboard or modules you can exchange MIDI data without a computer and without using two MIDI cables. See "Connecting the VIVO S10 to an USB MIDI Keyboard (USB host function)" (p. 19).

NOTE

* Carefully insert the USB Memory making sure that the connector on the device is appropriate and that it is connected in the proper direction.

* Dexibell does not recommend using USB hubs, irrespective of whether they are active or passive.

46 AUDIO IN socket

This mini jack allows you to connect the audio outputs of an external signal source (CD/mp3 player, etc.).

47 PHONES outputs

This is where you can connect one or two pairs of optional headphones.

4 Connections Quick Guide

Peripheral Devices

NOTE

Before to connect any external device to Audio IN socket, rotate the [VOLUME] knob counterclockwise to minimize the volume.

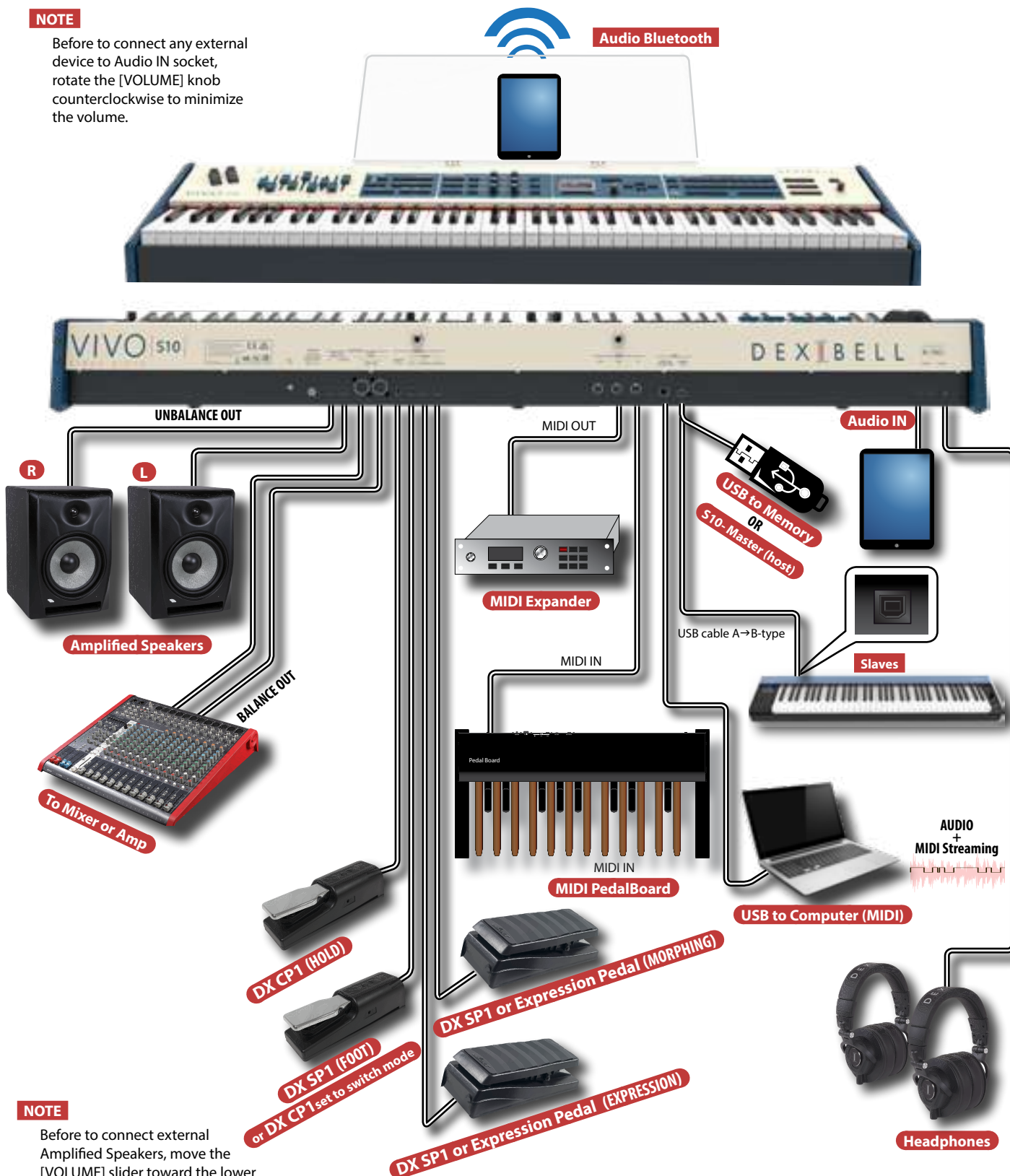

NOTE

Before to connect external Amplified Speakers, move the [VOLUME] slider toward the lower position to minimize the volume.

5 Quick Guide



The Motorised Draw-faders

Use these draw-faders in real time to create a variety of tonalities sliding them up and down. When recalling a presetted tonewheel or a memory, the draw-faders physically will move to reach the new current position. The display shows the numbers of each footage.

Select an Organ Type

The VIVO S10 reproduces the tonal characteristics of famous vintage organs. The "USER 1" and "USER 2" allow you to import sounds set downloadable from www.dexibell.com site.

1. Press the button repeatedly until the indicator of the desired organ type lights.

Add Overdrive Distortion

This function add a natural-sounding distortion as heard from a tube amp.

1. Press the [OVERDRIVE] button to activate the distortion. Its indicator lights.

Add Vibrato & Chorus

1. Press the [ON] button to activate the effect.
2. Press the [TYPE] button to select type of effect (V1, C1, V2, C2, V3, C3 and TREMULANT 1 ~ 6 only for the pipe organ sound).

Add Percussion to the Sound

The VIVO S10 give you the possibility to emulate the percussive sounds typical of vintage organ.

1. Press the [ON] button to activate percussion to the sound.
2. Pressing the "SOFT" button the percussion sound will be softer.
3. Pressing the "FAST" button the percussion sound will decay immediately, producing a sharper attack.
4. Press the [3rd/2nd] button to select between the third (the indicator lights) or second harmonics

Add Rotary Effect to the Sound

By this section you turn it on or off the Rotary effect. This effect simulates the typical sound modulation generated by a cabinet with rotating loudspeakers.

1. Press the [ON] button to add the rotary effect. Its indicator lights.
2. Press the [FAST/SLOW] button to select between the fast (the indicator lights) or slow speed.
3. Press the [BRAKE] button to stop the rotation of the rotary.

Adjusting by Draw-faders

You can control groups of parameters (Mixer, MIDI or EQ) by the Draw-faders.

1. Press the [MIXER] or [MIDI CTRL] button to control the related parameters group by Draw-faders.
2. To control the Master Equalizer parameters group press these two buttons simultaneously.

Assigning the Draw-faders

You can select organ sounds for the MAIN, LOWER and PEDAL keyboard parts. It's evident that only one part at the time can be assigned to the draw-faders section.

1. Press the [MAIN], [LOWER] or [PEDAL] button to assign the keyboard part to the draw-faders section.

Morphing Function

By this button you can manage some useful functions related to the movement of the draw-faders.

1. Press the [MORPHING] button to activate the function. For details please refer to the appropriate section.

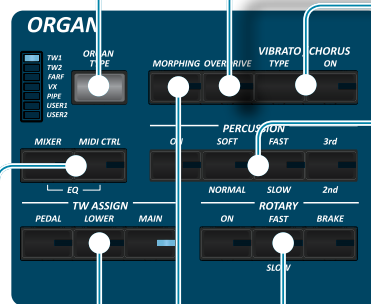
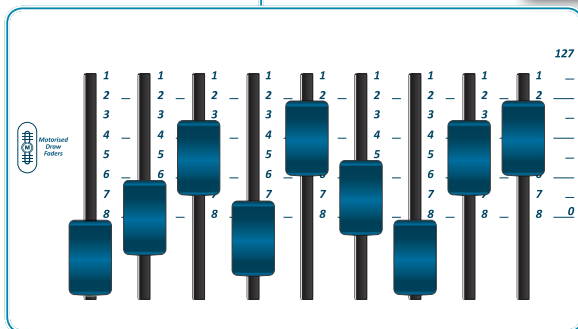



Effects for Orchestral Sounds

You have three AUDIO FX processor for each part (MAIN, COUPLED, LOWER and PEDAL).

1. Use the [FX SELECT] buttons to select which AUDIO FX processor (A, B or C) you want to control for the Main, Coupled, Lower and Pedal part. To select the AUDIO FX C processor, press the buttons [A] and [B] at the same time. The buttons [ON] and the control knobs (C1-C2, C3-C4, C5-C6) are assigned to the AUDIO FX processor you selected (A, B or C).
2. Use the [ON] buttons to switch ON/OFF the AUDIO FX processors for the relative parts (Main, Coupled and Lower/Pedal).
3. Use the C1/C2, C3/C4, C5/C6 control knobs to adjust the parameter value of the effect related to the current tone.

Controlling External Devices

1. Press the [C1~C6 / TO MIDI] button to control external MIDI devices by the control knobs C1-C6.

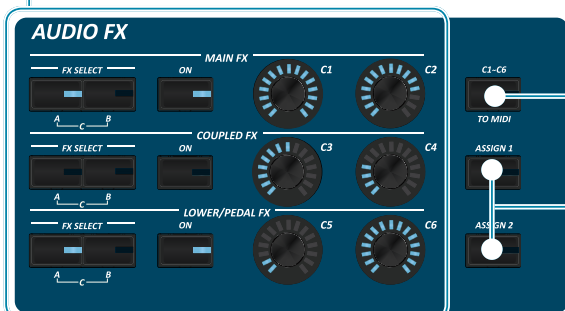

Assignable buttons

You can use them to directly access frequently used functions that are only available via the function menu.

Selecting a Tone

1. Press [SOUND] button.
2. Press one of buttons of the sounds family to recall a new tone.
3. Press one of the [1] to [9] button to select another sound in same the family.

HOW TO SET THE SELECTED TONE AS FAVORITE

1. Press and hold the same Sound number button previously pressed.

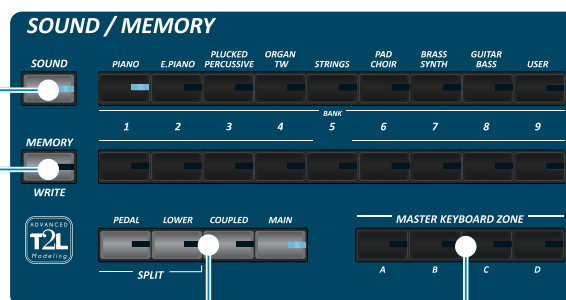

Favorite Settings

HOW TO MEMORIZE YOUR FAVORITE SETTING

The VIVO S10 allows you to memorize your favorite settings for easy recall whenever they're needed. Up to 81 complete setups can be saved.

1. Press and hold the [MEMORY/WRITE] button to call up the memories page (its indicator flashes).
2. Use the bank (Sound Families) and number buttons to select the position you want to replace the Memory.
3. Press the function button that shows "SAVE" at the bottom of the display.
4. Use the [DATA ENTRY] and [◀] [▶] buttons to enter the desired name.
5. To confirm press the function button that shows "OK" at the bottom of the display.

HOW TO RECALL YOUR FAVORITE SETTING

1. Press the [MEMORY] button to call up the memories page.
2. Use the bank (Sound Families) and number buttons to select the memory location.

Specifying the Keyboard Part

1. Press the relative button to specify the part you wish to assign to the keyboard.

If you press the [PEDAL] or [LOWER] button the keyboard is automatically splitted. See the parameter "SPLIT OFF" to use all parts in layer mode..

Master Keyboard Function

The VIVO S10 has four programmable separated MIDI zones. For each zone you can select the MIDI channel, the keyboard range, adjust the octave, transpose and many other parameters.

1. Press the relative button to specify the zone you wish to assign to the keyboard.
2. Press and hold one of the KEYBOARD ZONE buttons to access the edit page

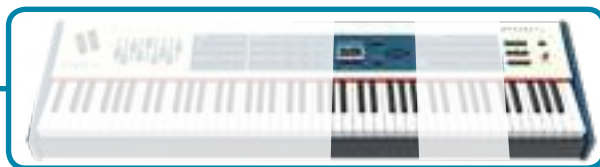

Managing the Sound Library

The VIVO S10 give you the possibility to install new sounds and manage existing ones.

1. Press the [SOUND LIBRARY] button to access the Sound Libraries environment.

CHORD ENHANCER and CHORD FREEZE

[CHORD ENHANCER]

This function improves the sound of the adding notes to the played chord. The Chord Enhancer function works when a not percussive tone is selected. See the Orchestral Sound List.

1. Select a not percussive sound. See the sounds table "VIVO S10's Tone List" (p. 82).
2. Press the CHORD [ENHANCER] to activate the function (its indicator lights).
3. Play a chord on the keyboard. The Chord Enhancer function adds notes to the chord you played.

[CHORD FREEZE]

The Chord Freeze allows you to memorize a complex chord and play it in different tonality on the keyboard using a finger only.

1. Playing and holding the chord (at least two notes) on the keyboard that you want "Freeze", press the CHORD [FREEZE] button. Its indicator lights.
2. Play a note on the keyboard with the desired tonality. The chord previously memorized is reproduced with the same tonality of the played note.

Record and Playback a Song

1. Press the [RECORD] button to start recording.
2. Play your song.
3. Press the [RECORD] button to stop recording.
4. Press the [PLAY/PAUSE] button to listen your recording.
5. Press the [PLAY/PAUSE] button again to pause the song.

Song Mode

1. Press the [SONG] button to enter in SONG mode (Its indicator lights).
2. Press the "SONG LIST" F2 function button. The display shows the contents of the Song internal memory.

Change the Keyboard Octave

The Octave function allows you to change the pitch of the selected part in octave steps.

1. Press the [OCTAVE] button.

Transposing the Keyboard

1. Press the [TRANPOSE] button to calls up the page where you can change the transposition value.
2. Use the [DATA ENTRY] knob or the [LEFT] [RIGHT] buttons to change the value.

Managing the Aftertouch

This function that lets you modify the sound by applying additional pressure to the key.

1. Press the [AFTERTOUCH] button to enable the Aftertouch function. Its indicator lights.
2. Press and hold the [AFTERTOUCH] button to open the Aftertouch page to edit the parameters.

T2L Editor

1. Press this button to open the T2L page and personalize the sounds of the instrument.

Menu/Exit button

1. Press this button to open and close the menu page where you can view and select all available functions.

Function Buttons

1. Press these buttons to select functions/options shows at the bottom of the display.

Data Entry/Song Volume

When a parameter is selected this knob works as Data Entry. When the instrument is in song mode, this knob allows you to set the volume of the song player.

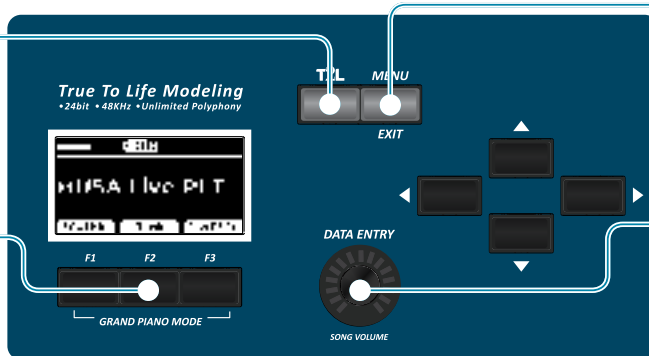

6 Before You Start to Play

Connecting the AC Adaptor

1. Rotate the [VOLUME] knob toward the left position to minimize the volume.
2. Connect the included power cord to the AC adaptor.
The indicator will light once you plug the AC adaptor into a wall outlet.



NOTE

Depending on your area, the included power cord may differ from the one shown above.

NOTE

Be sure to use only the AC adaptor (DEXIBELL DYS602-240250W or DEXIBELL DYS865-240250W) supplied with the unit. Also, make sure the line voltage at the installation matches the input voltage specified on the AC adaptor body. Other AC adapters may use a different polarity, or be designed for a different voltage, so their use could result in damage, malfunction, or electric shock.

NOTE

If you won't be using the VIVO S10 for an extended period of time, disconnect the power cord from the electrical outlet.

NOTE

To avoid malfunctions, never disconnect the AC/DC adaptor while the instrument is turned on.

3. Connect the AC adaptor to the VIVO S10's DC IN jack positioned to the rear bottom panel. Secure it manually screwing the ring nut to the DC IN socket.

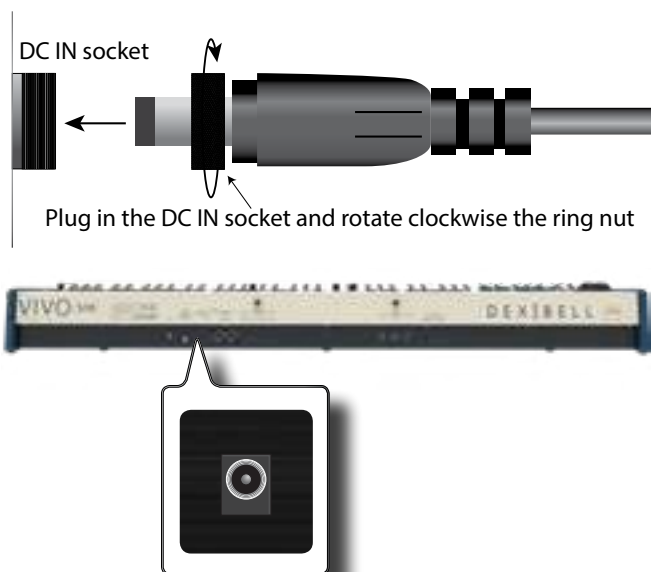

Connecting External Audio Amplifier

You can connect the unbalanced or balanced OUTPUT R L/MONO jacks to an external amplifier, mixing consoles, etc. All parts of the instrument can

be routed to the different outputs (MAIN or SUB) as desired. For details see "Specifying the Audio Output for Each Part" (p. 37).

NOTE

If you want to use only one channel on your external amplifier, connect the L/MONO TS socket. For optimum sound quality, we recommend working in stereo, though.

1. Rotate the [VOLUME] knob toward the left position to minimize the volume.
2. Connect the VIVO S10's OUTPUT jacks to the inputs of your external audio device.

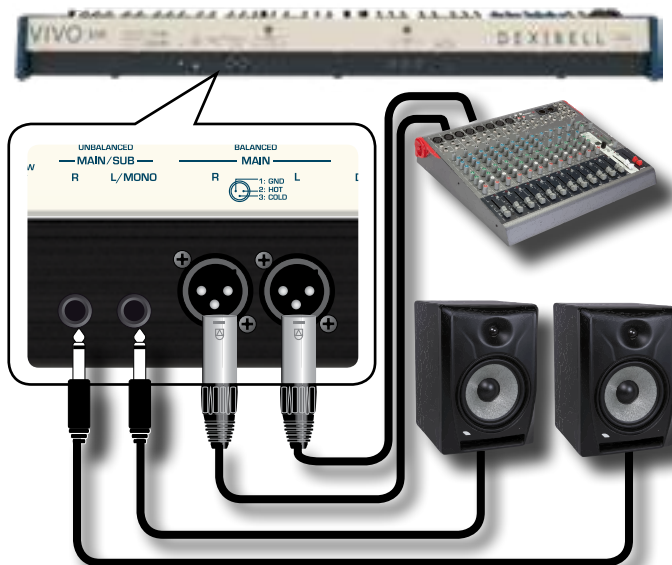

Connecting the Pedals

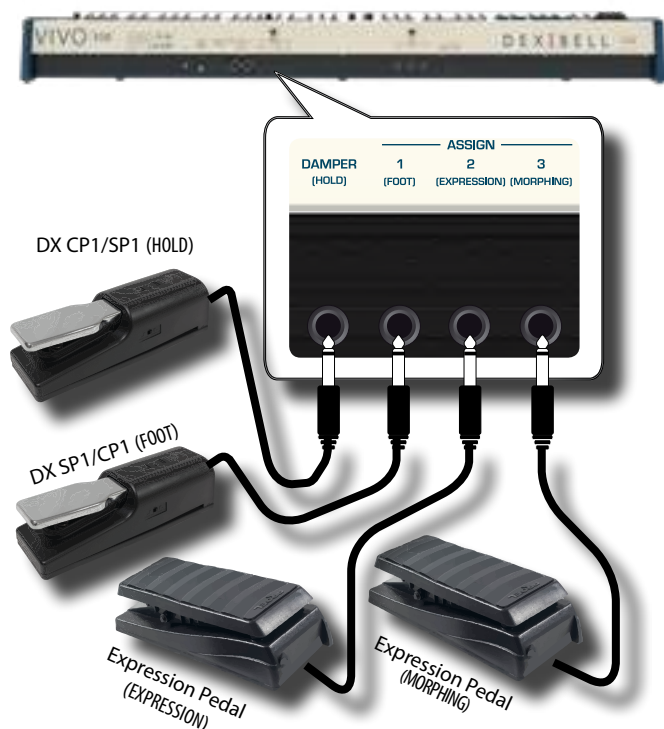

1. Connect a sustain pedal to the DAMPER (HOLD) socket.

This is the most commonly used pedal in percussive instruments. When the pedal is pressed, all notes played will continue to sound until the vibration naturally ceases.

It's possible to choose which parts the pedal acts on. See "DAMPER PEDAL" (p. 70).

NOTE

We suggest to connect at this socket a continuous pedal controller (DX CP1 set in continuous mode). In this way you can appreciate all the musical nuances of a continuous controller.

2. Connect a foot-switch to the ASSIGN 1 socket.

An optional foot-switch connected to the ASSIGN 1 socket can be used to perform various functions. For detail see "ASSIGN 1 PEDAL" (p. 70).

NOTE

The ASSIGN 1 socket accepts foot-switches ON/OFF type only. You can use a DX SP1 or a DX CP1 set in switch mode.

3. Connect an expression pedal to the ASSIGN 2 (EXPRESSION) socket.

The ASSIGN 2 socket is assignable in a way that various functions can be assigned to it.

If you connect a continuous control pedal and the "Expression" function is active (default), you can control the volume of the Organ, Orchestra and Piano sections. To assign other functions, please refer to "EXPRESSION PEDAL" (p. 71).

If you connect a foot-switches ON/OFF type see "ASSIGN 2 PEDAL" (p. 70).

4. Connect an expression pedal to the ASSIGN 3 (MORPHING) socket.

The ASSIGN 3 socket is assignable in a way that various functions can be assigned to it.

If you connect a continuous control pedal and the Morphing function is active (default), you can use an expression pedal to drive the transitions between two different combinations of draw-faders (MORPHING). See "Useful Draw-faders Movement Functions (Morphing)" (p. 30)

If you connect a foot-switches ON/OFF type see "ASSIGN 3 PEDAL" (p. 70).



2. Rotate the VIVO S10's [VOLUME] knob to adjust the volume of the headphone.

Cautions when using headphones

- To prevent damage to the cord's internal conductors, avoid rough handling. When using headphones, mainly try to handle either the plug or the headset.
- Your headphones may be damaged if the volume of a device is already turned up when you plug them in. Minimize the volume before you plug in the headphones.
- Excessive input will not only damage your hearing, but may also strain the headphones. Please enjoy music at a reasonable volume.

Connecting Digital Player Devices

You can connect the INPUT mini jack to an audio playback device.

- 1. Rotate the [VOLUME] knob toward the left position to minimize the volume.**
- 2. Connect the VIVO S10's AUDIO IN mini jack to the output of an external signal source.**



- 3. To adjust the input level the VIVO S10's AUDIO IN, press the [MENU] button and select the AUDIO INPUT function.**

Connecting the VIVO S10 to Your Computer

If you use a USB cable (commercially available) to connect the USB COMPUTER port on the VIVO S10's rear panel to your computer's USB connector, you can record and play audio and/or MIDI data by your MIDI software (DAW software).

Listening Through Headphones

You can use headphones to enjoy the VIVO S10 without disturbing those around you.

- 1. Here you can connect stereo headphones. The VIVO S10 has two headphones jacks. Two people can use headphones simultaneously.**

Connecting the VIVO S10 to an USB MIDI Keyboard (USB host function)

NOTE

To use the USB audio streaming you need of a computer equipped with MAC OSX or LINUX.

NOTE

The VIVO S10 does not support GM/GS standard.

1. Use a standard USB cable (A→B-type connectors, commercially available) to connect the VIVO S10 to your computer as shown below.

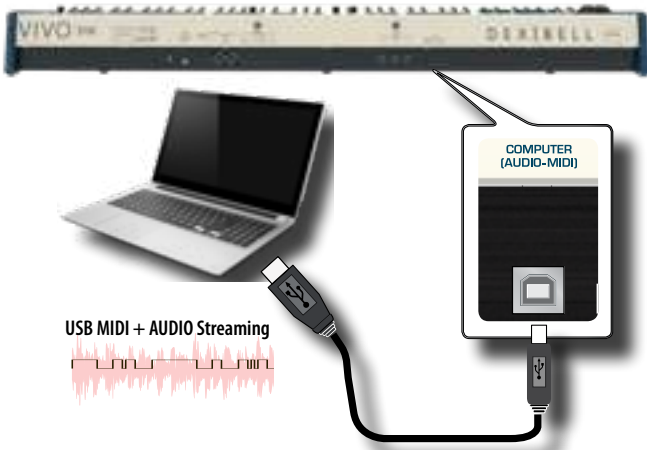

NOTE

- Switch on the VIVO S10 before you start up the DAW software on your computer.
- Before to connect any other equipment, move the [VOLUME] knob counterclockwise to minimize the volume.

To adjust the USB audio level see "USB AUDIO" (p. 74).

Connecting the VIVO S10 to an USB MIDI Keyboard (USB host function)

Using the following connection, your keyboard becomes a master (host). You can connect other keyboards or modules from any brand directly to the DEXIBELL USB "Memory" port and exchange MIDI data without a computer and without using two MIDI cables.

The connection consists of the following main components:

- Your DEXIBELL keyboard.
- One slave MIDI USB Devices as a keyboards.
- A physical bus represented by the USB cable that links the devices with the host.

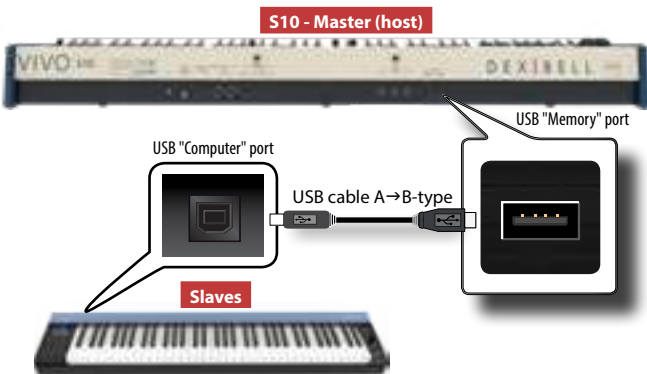

Connecting the VIVO S10 to MIDI devices

MIDI is an universal standard, which means that musical data can be sent to and received by instruments of different types and manufacturers. MIDI allows you to connect your instrument to another devices as an MIDI

sound module.

Here below an example of MIDI connection:

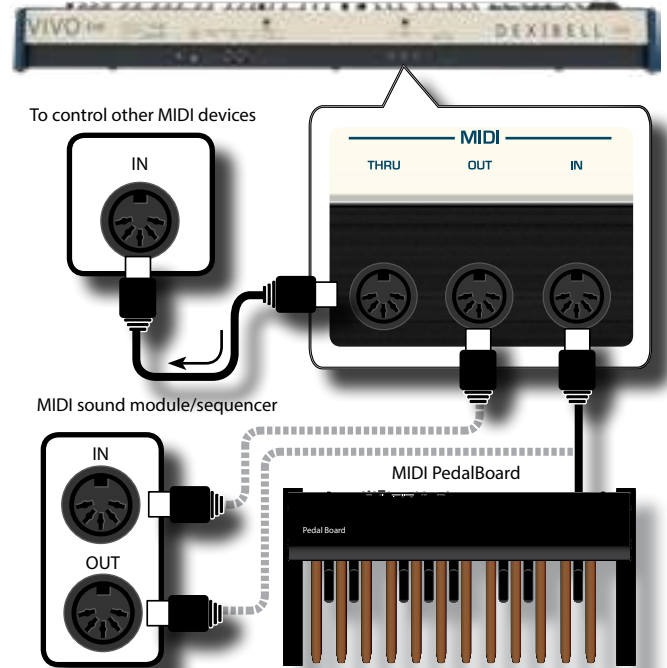

1. Use an optional standard MIDI cable (code: CHL400LU15) to connect the VIVO S10 MIDI OUT socket to the MIDI IN socket of the external MIDI device.
2. If necessary, use an optional standard MIDI cable (code: CHL400LU15) to connect the MIDI OUT socket of the external device to the VIVO S10 MIDI IN socket.
3. If you need to re-send the MIDI messages received by the VIVO S10 IN socket to another device, connect the THRU socket using an additional MIDI cable (code: CHL400LU15) to the relative MIDI IN socket.

For details on MIDI settings of the external device, refer to its owner's manual.

Connecting an USB Memory (commercially available)

1. As shown in the illustration, connect an USB Memory to the MEMORY port.

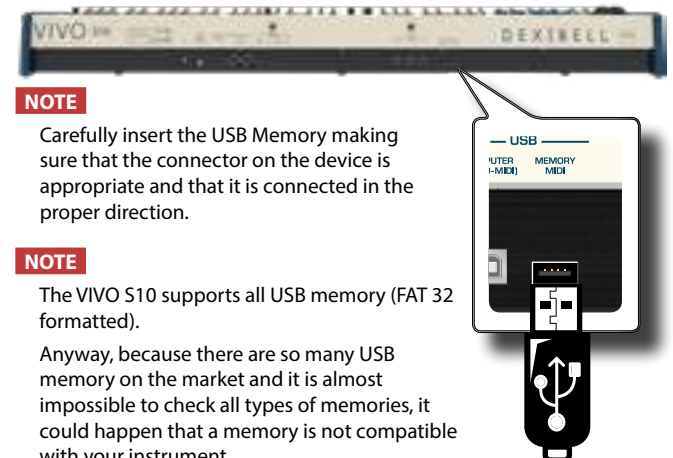

NOTE

Carefully insert the USB Memory making sure that the connector on the device is appropriate and that it is connected in the proper direction.

NOTE

The VIVO S10 supports all USB memory (FAT 32 formatted).

Anyway, because there are so many USB memory on the market and it is almost impossible to check all types of memories, it could happen that a memory is not compatible with your instrument.

How to Format the USB Memory

1. Press the "MENU" button.



2. Use the [▲] [▼] buttons to select the "USB MEMORY" functions group and press the [▶] button to access them.



3. Use the [▲] [▼] buttons to select "FORMAT" and press the [EXECUTE] Function button to access the function.

The display shows:

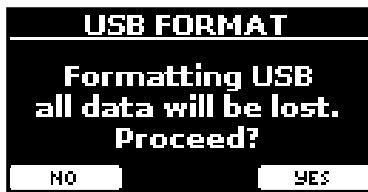

1. Press the "YES" Function button to format the USB Memory.

A confirmation message informs you that the USB memory has been formatted.

Safely Remove the USB Memory

IMPORTANT

You should always safely eject the USB Memory before physically unplugging it from USB socket. Before to unplug the USB Memory use the "USB REMOVE" function.

1. Press the [MENU/EXIT] button.
2. Use the [▲] [▼] buttons to select the "USB MEMORY" functions group and press the [▶] button to access them.
3. Use the [▲] [▼] buttons to select the "REMOVE" function and press the [EXECUTE] function button to access the function.

The display shows:



1. Press the "YES" Function button to safely remove the USB Memory.

Now you can unplug the USB Memory safely.

Installing Music Rest

Install the included music rest as shown in the illustration below.

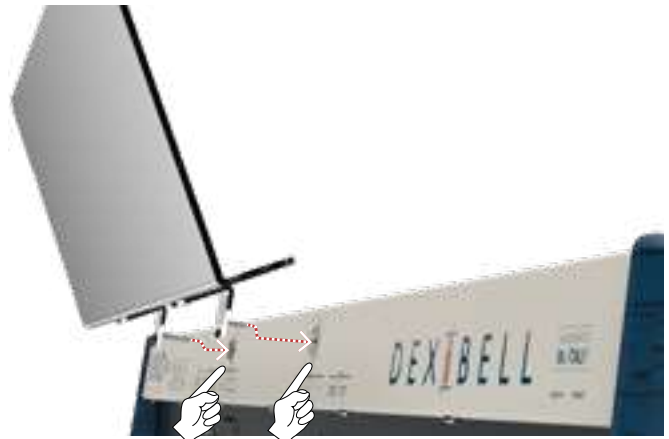

Ground Terminal

Depending on the circumstances of a particular setup, you could feel a tingling sensation at the point where you touch this device.

You can eliminate this sensation connecting the ground terminal with an external ground.



1. Use the screw-type ground terminal to connect to ground or to connect to the chassis of the mixer, preamp, or other device in your system.

Turning the Power On

Once everything is properly connected, be sure to follow the procedure below to turn on their power.

1. Rotate the [VOLUME] knob toward the left position to minimize the volume.

NOTE

Before turning the VIVO S10 on/off, always be sure to turn the volume down. Even with the volume turned down, you might hear some sound when switching the VIVO S10 on/off.

However, this is normal and does not indicate a malfunction.

2. Press the VIVO S10's [⏻] button located on the right panel to switch it on.



The power will turn on, a progress bar appear in the VIVO S10's display.



After a brief interval, the main page will appear. and VIVO S10 will be ready to produce sound.



3. Use the [VOLUME] knob to adjust the volume.

NOTE

This unit is equipped with a protection circuit. A brief interval (a few seconds) after power up is required before the unit will operate normally.

Turning the Power Off

1. Rotate the [VOLUME] knob toward the left position to minimize the volume.

NOTE

To avoid malfunctions, never disconnect the AC/DC adapter while the instrument is turned on.

2. Press the VIVO S10's [] switch.

A power off confirmation message appears:



3. Press the "YES" Function button to confirm.

The display shows the following message:



and the unit will turn off after few seconds.

If you do not want power off press the "NO" Function button.

NOTE

If you need to turn off the power completely, first turn off the instrument, then unplug the power cord from the power outlet. Refer to "Connecting the AC Adaptor" (p. 17).

If you do not operate the unit for a certain period of time while the power is on, this unit turns off automatically.

If you don't want the power to turn off automatically, turn the "AUTO OFF" setting off!

With the factory settings, the unit's power will automatically be switched off 120 minutes after you stop playing or operating the unit.

Shortly before the VIVO S10 shuts down automatically, the display starts counting down the seconds. If you want to keep using the VIVO S10 at this stage, press any button.

If you don't want the power to turn off automatically, change the "AUTO OFF" setting to "OFF" as described on p. 77.

Demo of the VIVO S10

Your VIVO S10 contains a demo that introduces all the best of its tones.

1. To start playback of all demo songs simultaneously press the [] and [SONG] buttons.

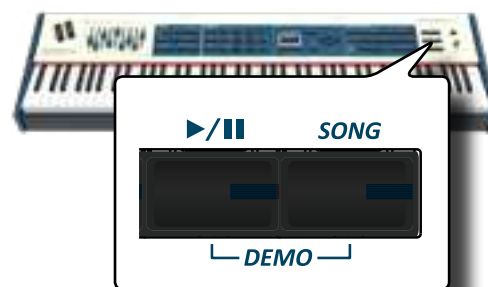

Playback starts automatically with the demo song.

2. Press the [MENU/EXIT] button to leave the demo function.

NOTE

No data for the music that is played back will be output from MIDI OUT.

NOTE

All rights reserved. Unauthorized use of this material for purposes other than private, personal enjoyment is a violation of applicable laws.

7 Basic Operation

About the Display and Cursor Operation

This section introduces the information that appear on the main page. Moreover this section illustrates how to navigate the menu.

Main Page

The main page contains many useful information.

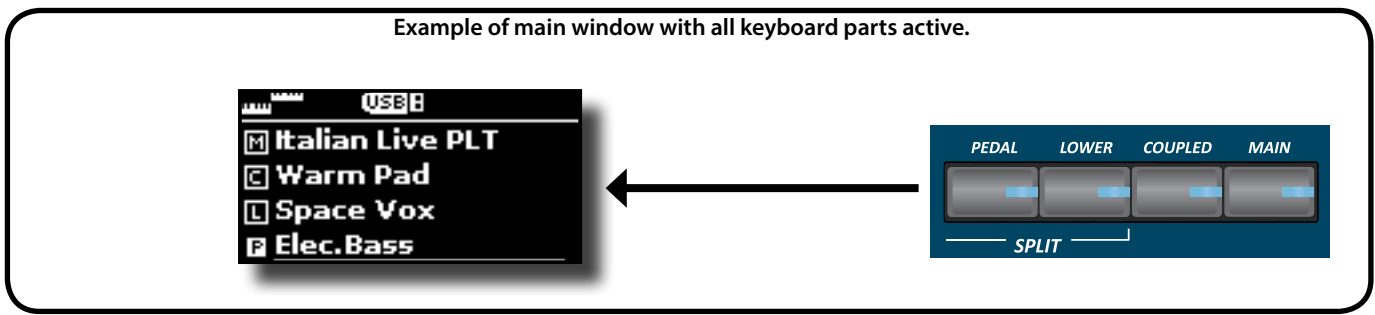
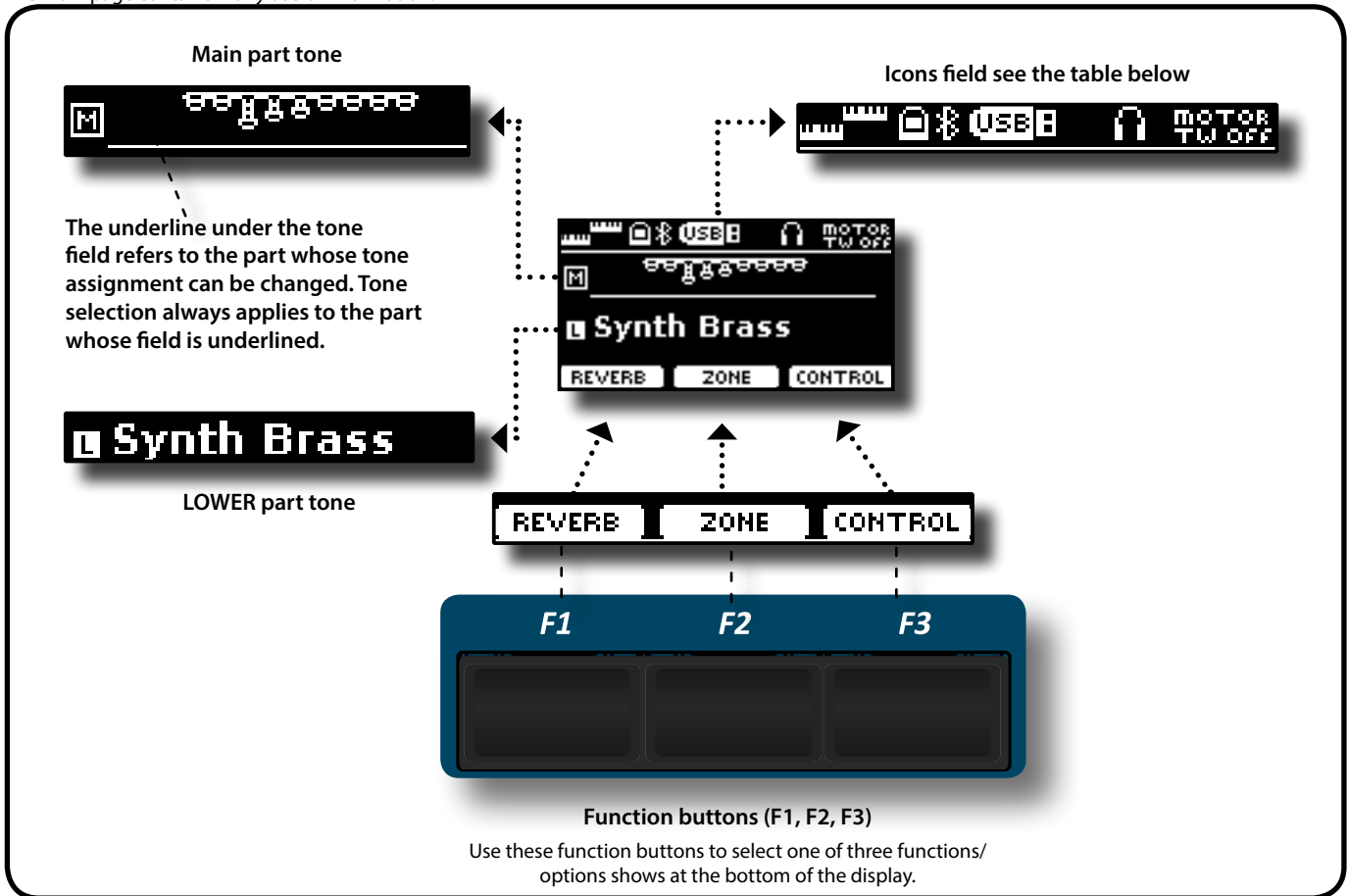

Icons Field	Explanation	Icons Field	Explanation
	Keyboard Mode:		Bluetooth indicator • Steady icon: Connected to a device.
	• No SPLITED		A USB memory is connected to your unit.
	• SPLITTED (PEDAL or/and LOWER)		An headphone is plugged into the PHONES output jack.
	A computer is connected to the VIVO S10's USB "COMPUTER" port.		The "Motor Slider" parameter is set to "Off". See "Motor Slider" (p. 77).

Moving the Cursor and Setting Parameter Values

1. Press the [MENU/EXIT] button to access to the available function groups.

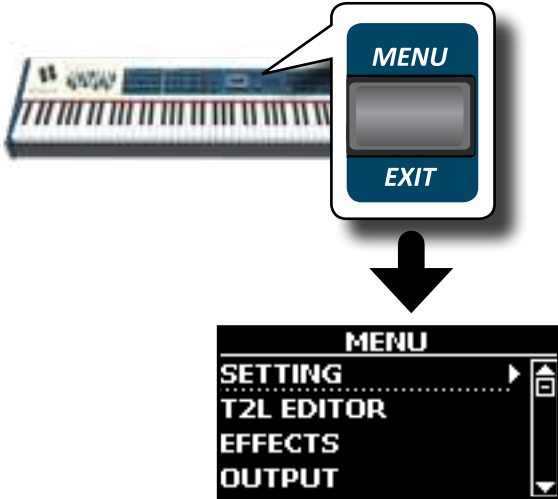

2. Use the [DATA ENTRY] knob or the [▲][▼] buttons to select the entry of the desired function group.

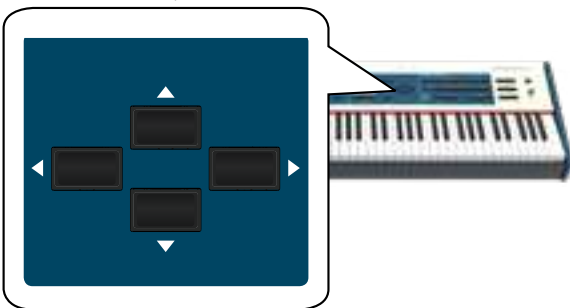

3. Press the [▶] button to enter in the selected function group.



4. Use the [DATA ENTRY] knob or the [▲][▼] buttons to scroll the list of settings and press the [▶] button to enter in the selected setting.
5. Use the [▲][▼] buttons to scroll the list of parameters. The selected parameter field is displayed in reverse
6. Use the [DATA ENTRY] knob or the [◀][▶] buttons to set the desired value.



7. Press the [MENU/EXIT] button to return to the main page.

Assigning the Name You Specify

In many cases you'll have to assign a name to a file. In the following example, we will learn how to give a Memory name.

After the selection of saving a Memory, the display looks as follows:



A Memory name is suggested by the VIVO S10.

1. Use the [DATA ENTRY] knob or the [▲][▼] buttons to select a different character.
2. Use the [◀][▶] buttons to select the next character position you want to change, then select the new character using the [DATA ENTRY] knob or the [▲][▼] buttons.
3. You can press the [A/a/#] F2 Function button to switch between Main- and lower-case characters as well as numbers.

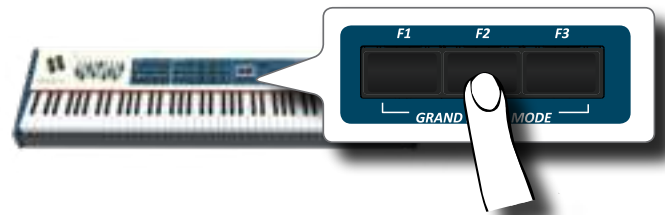

4. To delete the selected character, simultaneously press the F2 and F3 Function button.

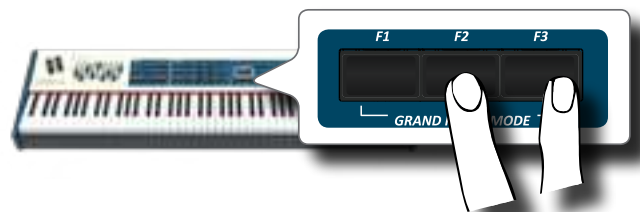

5. To insert a character, simultaneously press the F1 and F2 Function button.



8 Selecting Tones

VIVO S10 has a wide selection of high quality tones arranged in nine categories. In particular, thanks to new sound engine, the Piano tones are faithfully reproduced with all the subtle nuances of a real acoustic piano. VIVO S10 also includes a section that simulates famous electric organs. Some organ sounds are preset by factory and you will find them in the "ORGAN TW" family. For more details see "Organ Section" (p. 29). The VIVO S10 allows you to assign any of the available tones to any of the four real-time parts. Tone selection always applies to the part (Main, Coupled, Lower or Pedal) whose field is currently underlined in the main page.

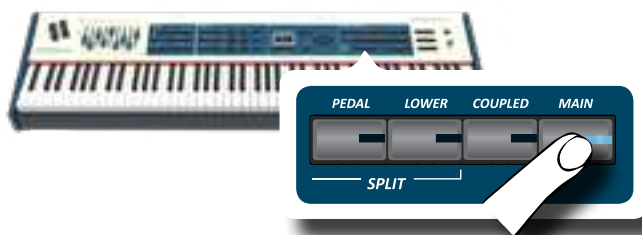

Grand Piano Mode

NOTE

At power-on, the instrument is automatically selected in Grand Piano Mode.

1. From the Main page, simultaneously press the first and last Function button.



The "Grand Piano" tone is called and all various parameters are modified to play the best piano sound.

2. Play the keyboard to enjoy the piano sound.

All keyboard play piano sound.

Main Part



How to Customize and Save Your Grand Piano Mode Configuration

You have the possibility to customize the configuration of the Grand Piano mode by changing the tone and the various parameters of the instrument and save your configuration through the "SAVE AS G.P. MODE function.

For more information, please see "How to Customize the Grand Piano Mode" (p. 54).

How to Select a Part

Your VIVO S10 provides four parts (Main, Coupled, Lower, Pedal) that allow you to play different sounds on the keyboard.

Before to operate a tone change you need to select on which part you want to do it.

At power-on, the Main part is automatically switched on and assigned to the entire keyboard.

How to Select Tones

If you want to select the [TW/ORGAN] sounds, please refer to the "Organ Section" (p. 29).

1. If the [SOUND] button is not already lit, press it to enable the nine family and number buttons to select tones.



The [SOUND] button lit.

2. Press the desiderate Family Tone button to select the sound category that you want to play.

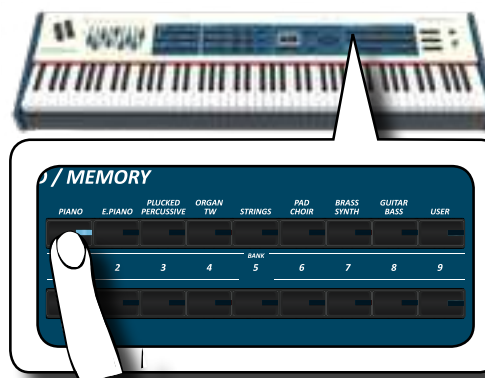

The last sound you selected for that category is recalled.

The button indicator lights and a temporary window shows the list of tones where the recalled sound is underlined:



In the example was pressed [PIANO] button.

MEMO

While the tone window is active, use the [DATA ENTRY] knob or the [▲] [▼] buttons to select a tone in the same category. If during normal operation the window closes automatically, press the tone family buttons again.

3. Press the desiderate [1 ~ 9] Tone button to select a tone in the same category.

Most Frequently Used Tones (Favorite Tone)

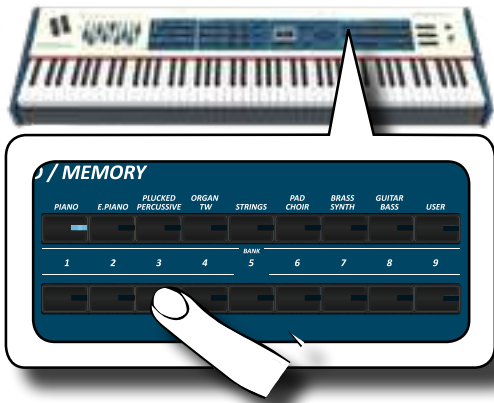

The tone is selected and the window highlight you the name of the tone. After few seconds of inactivity of the change tone operation, the Main page is shown.

See page 82 for a list of available Tones.

4. Play the keyboard.

You'll hear the sound of the selected instrument.

MEMO

The last sound you select in each category is memorized temporarily and will be recalled every time you press the corresponding Family Tone button

MEMO

While the tone window is active, press the [◀] [▶] buttons to select the previous or next tone category. After few seconds of inactivity of the change tone operation, the Main page is shown.

TIPS

A quick way to change a tone from the Main page: use the [◀] [▶] buttons to select a next or previous tone in the same category.

Most Frequently Used Tones (Favorite Tone)

The "Favorite Tone" function lets you an easy recall of most frequently used sounds. You can memorize a Favorite Tone for each of nine categories and recall it simply pressing the tone button. It will be helpful in a live performance situation.

1. Select a tone you prefer. See "How to Select Tones" (p. 24).
2. Press and hold the Family Tone button that contains the selected tone to memorize it.

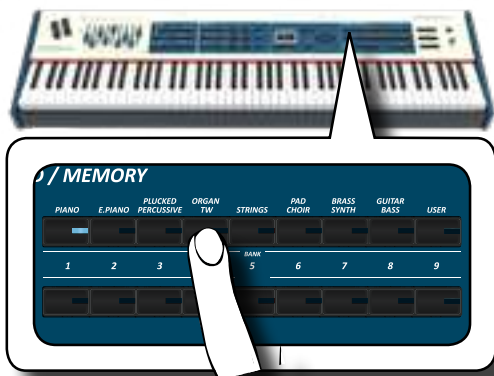

The display shows a confirmation message.

The position of the sound you selected is memorized and will be recalled every time you press the corresponding Tone button.

The instrument will remember your choice at the next power on.

NOTE

This function is not available for the "TW/ORGAN" family tone.

Playing Two Sounds Over the Entire keyboard (Layer)

In the previous paragraph "How to Select Tones", you learned how to select a Tone. Below you'll learn how to add a second sound over the entire keyboard (Main + Coupled part).

1. Press the [COUPLED] button to add a second tone (Coupled Part) over the entire keyboard.



The Coupled part [C] is automatically selected.

If the main page is displayed shows:



The Coupled part [C] field in the main page is underlined to inform you that the tone selection is applied on this part.

NOTE

For Tone selection, it would be a good idea to check on the main page which part is currently selected to ensure that you don't select a Tone for the wrong part.

NOTE

Note that you cannot select a tonewheel preset for the Coupled part. This because the Coupled part is not a typical organ part. The organs have only three keyboard parts: Main, Lower and Pedal.

2. Play the keyboard.
You'll hear the tones of Main part [M] and Coupled part [C] playing together.
3. To adjust the overall volume use the VOLUME knob.
4. To adjust the volume for the Main and Coupled keyboard see "Adjust the Volume and Reverb for Each Part by the Draw Faders" (p. 27).
5. To change a tone of the Coupled part, see "How to Select Tones" (p. 24).
6. To select the Main part, from the main page, use the [DATA ENTRY] knob or the [▲] [▼] buttons to select it.
7. To change a tone of the Main part, see "How to Select Tones" (p. 24).

Splitting the Keyboard Range and Playing Two Different Tones (LOWER)

Split mode enables you to play two different voices on the keyboard, one with the left hand (LOWER) and another with the right hand (MAIN).

1. If you want to use your left and right hands to play different Tones, press the [LOWER] button.



The Keyboard is divided into two sections. The region of the keyboard to the left of the split point becomes the LOWER part while the region of the keyboard to the right of the split point becomes the MAIN part.

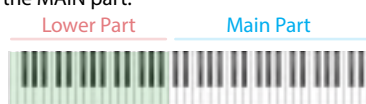

If the main page is displayed shows:



The Lower part [L] field in the main page is underlined to inform you that the tone selection is applied on this part.

2. Play the keyboard.

Turn the VOLUME slider to adjust the volume.

NOTE

Setting the "SPLIT" parameter in "OFF" you can play the Lower part in layer mode with the Main and Coupled parts. See "Play All Parts in Layer Mode" (p. 26).

MEMO

The default split point is set between keys B3 and C4. To change the split point see "How to change the Split Point" (p. 27).

3. To adjust the volume for the Main and Lower keyboard part see "Adjust the Volume and Reverb for Each Part by the Draw Faders" (p. 27).
4. To change a tone of the Lower part, see "How to Select Tones" (p. 24).
5. To select the Main part, from the main page, use the [DATA ENTRY] knob or the [▲] [▼] buttons.
6. To change a tone of the Main part, see "How to Select Tones" (p. 24).

Adding the PEDAL Part

The Pedal part can be played via the keyboard, or by an commercially available MIDI pedalboard.

1. Press the [PEDAL] button to add the pedal part on the keyboard. Its indicator lights.



The Keyboard is divided into two halves. The region of the keyboard to the left of the split point becomes the Pedal part, while the region of the keyboard to the right of the split point becomes the Main part.

If the Lower part is active, the pedal part is monophonic and the leftmost note played on the keyboard is added. In all other cases the Pedal part is polyphonic.

2. To change a tone of the PEDAL part, see "How to Select Tones" (p. 24).

3. Play the keyboard.

Turn the VOLUME knob to adjust the volume.

MEMO

The default split point is set between keys F3 and F#3. To change the split point see "How to change the Split Point" (p. 27).

4. To adjust the volume for the Main and Pedal keyboard part see "Adjust the Volume and Reverb for Each Part by the Draw Faders" (p. 27).

Special Pedalboard Tones: "Pedal Bass" and "Pedal DoublBs"

In the sounds set of the VIVO S10 there are two special sounds that came in handy when you play bass note in rapid succession like jazz. The "Pedal Bass" and "Pedal DoublBs" sounds were sampled with a little bit sustain. In this way, lengthening the release of the sound, allows the organist to play the "walking" bass line.

Play All Parts in Layer Mode

The VIVO S10 give you the possibility to play the Lower and Pedal in layer with the Main and the Coupled part. To do this you need to set a parameter in off, this parameter is called "Split"



1. Press and hold the [LOWER] or the [PEDAL] button until the display shown the following page.



- Use the [▲] [▼] buttons to select the "Split" parameter.
- Use the [DATA ENTRY] knob or the [◀] [▶] buttons to set the "Split" parameter to OFF.

Parameter	Setting
Split	OFF, ON Default: ON

Now all parts will play in layer.

MEMO

To play the keyboard in split mode set again the "SPLIT" parameter to "ON".

How to change the Split Point

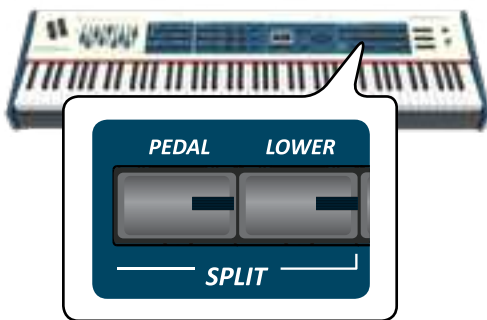

- Press and hold the [LOWER] or the [PEDAL] button until the display shown the following page.



- Use the [▲] [▼] buttons to select the "Split Point" parameter.
- Use the [DATA ENTRY] knob or the [◀] [▶] buttons to change the split point value.

Parameter	Setting
Split Point	F1 ~ E7 Default: C4

MEMO

The "Split Point" parameter works when the keyboard is in split mode (Lower or Pedal part is selected) and the "Split" parameter is set to "ON" (default).

Adjust the Volume and Reverb for Each Part by the Draw Faders

By the draw faders you can adjust the volume for each part.



- Press [MIXER] button to assign the 9 draw faders to adjust the volume or/and reverb for each part.
- You can adjust the volume for each part moving the corresponding draw faders. On the panel, below each one of draw fader, is indicated the assigned part.
- You can adjust the reverb for each part moving the corresponding draw faders. On the panel, below each one of draw fader, is indicated the assigned part.

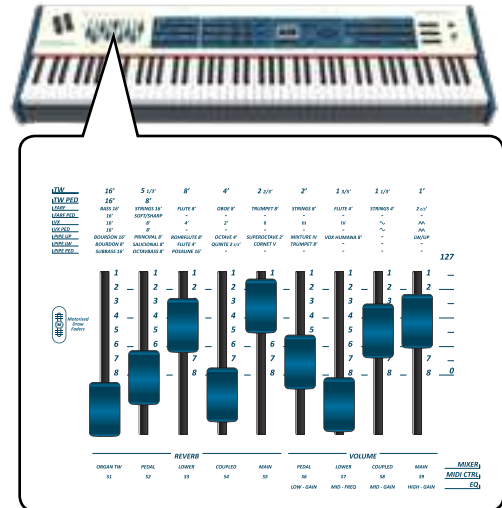

How to Reorder the Tone List

Use this function if you need to reorder the tones list. If you wish, you can move the position of the individual tone in the list.

- Press the [MENU/EXIT] button and select SOUND LIST.



The display shows the tone list.



- Use the the [DATA ENTRY] knob or the [▲] [▼] buttons to select the tone you want to reorder.



- Press the "MOVE" function button.

An  symbol appears to the left of the selected tone.



- Use the [DATA ENTRY] knob or the [▲][▼] buttons to select the new position where you want to move the selected tone. If you want move the tone in another category use the [◀][▶] buttons.

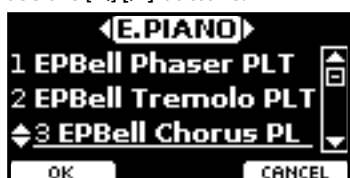

- Press the "OK" Function button to confirm the operation. Press "CANCEL" Function button to cancel the operation.

Tone MIDI Information

Tones can also be selected via MIDI. To this effect, they use an "internal" address, which is not usually displayed. For MIDI applications involving sequencers or external controllers, knowing the "official" address may come in handy. The VIVO S10 has a handy system that provides this information instantly—there is thus no need to look up the MIDI address in the tones list at the end of this manual.

- Select a tone. See "How to Select Tones" (p. 24).

The following temporary page is showed:

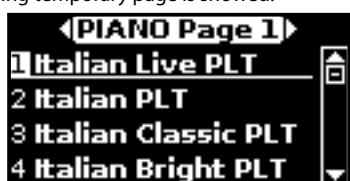

In the example above we selected "VIVO Live" tone.

- Press one of the Function buttons located below the display



The tone MIDI information are temporary showed:



9 Organ Section

The VIVO S10 has a section that simulates famous electric organs. You can select many presetted organ sound and by sliding the nine motorised draw-faders you can create a wide variety of tonalities and save them in the instrument's internal memory. You can add various typical effects of an electric organ as a Leslie speaker.

Selecting Various Organ Types

The VIVO S10 comes with various organ models that reproduce the tonal characteristics of both tonewheel and transistor types organ: TW1, TW2, FARF, VX and PIPE. Moreover you have two user organ memory location (USER 1, USER 2) that allows you to expand the tonal resources of the instrument. You can download this selection of sounds from the www.dexibell.com website. See "How To Load Sound Libraries in a USB Memory" (p. 41).

The modification of the sound within the Organ section is primarily done through the use of Draw-faders. You can recall various position setting of them by the selection of bank and number buttons in the SOUND/MEMORY section.

1. Repeatedly press the [ORGAN TYPE] button until the indicator of the desired selection lights.

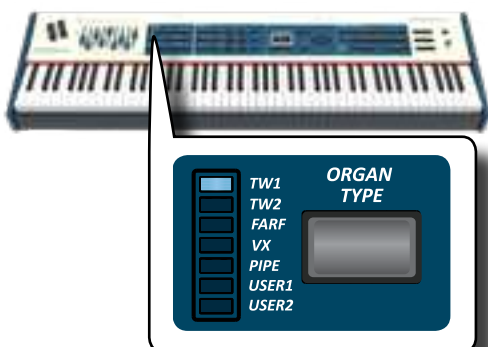

Organ Type	Explanation
TW1	It's a simulation of a organ style cabinet that use an tonewheel apparatus for generating electric musical note.
TW2	It's a simulation of an "home organ" style cabinet with some built-in speakers" that use an tonewheel apparatus for generating electric musical note.
FARF	This is a simulation of a portable transistors-based organ.
VX	This is a simulation of transistor-based combo organ.
PIPE	This simulate a pipe organ. It's a musical instrument that produces sound by driving pressurized air through organ pipes.
USER1	You can download sounds from the www.dexibell.com website. See "Additional Sound (Sound Library)" (p. 40).
USER2	

The organ type selection is now available.

2. See "Selecting Presetted Organ Sounds" (p. 29) to select a tonewheel for that organ type.

Selecting Presetted Organ Sounds

1. Select the organ model you desired. See "Selecting Various Organ Types" (p. 29).
2. If the [SOUND] button is not already lit, press it to enable the nine family and number buttons to select tones.



The [SOUND] button lit.

3. Press the [TW ORGAN] button to select the tonewheel organ family.

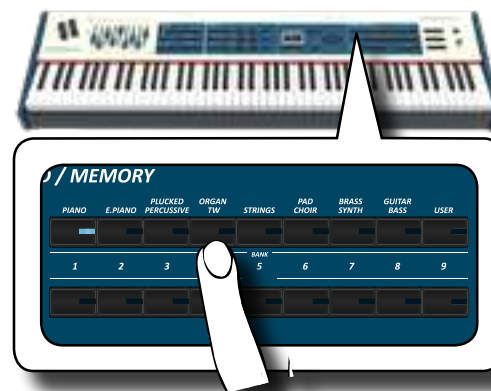

The last sound you selected for the organ category is recalled and the draw-faders move to reach the new footage value.

The button indicator lights and a temporary window shows the list of draw-faders where the recalled combination is underlined:



"Manual" indicate the current position of draw-faders.

The other items of the list indicate the most used combinations. Each number is the indication of the single draw-faders position value. For example, the "00 5320 000" corresponds to the following position of draw-faders:

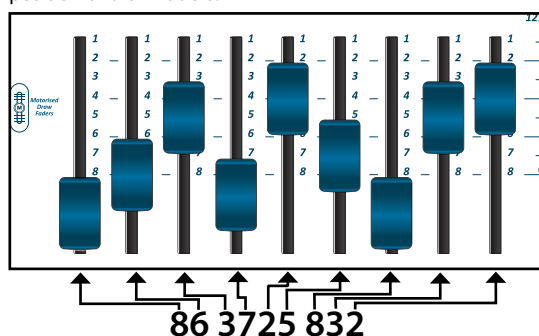

MEMO

While the tone window is active, use the [▲] [▼] buttons to select a tone in the same category. If during normal operation the window closes automatically, press the tone family buttons again.

4. Press the desiderate [1 ~ 9] button to select the organ preset in the same category.

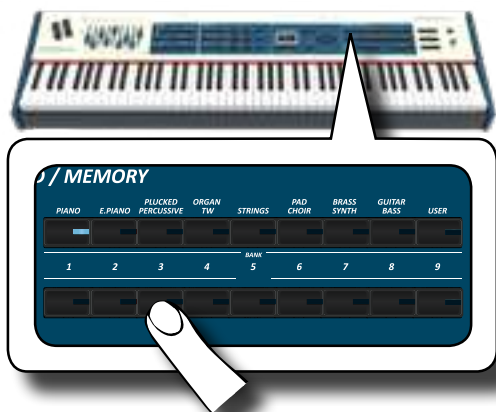

The tonewheel is selected and the window highlight the configuration of the draw-faders. The draw-faders move to reach the new footages position.

After few seconds of inactivity of the change tone operation, the Main page is shown. The main page shows the current position of each draw-faders and the footage indication.

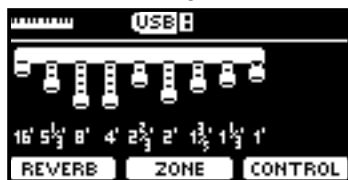

On the instrument panel, under or above each draw-fader, the feet used for each type of organ are listed.

5. Play the keyboard to enjoy the organ sound.
6. Use the draw-faders to change in real time the volume of each footage (See "Altering the Sound using Draw-faders" (p. 30)) or select another tonewheel.

volume).

2. Move the draw-fader up to decreases the volume of that footage.

The main page shows the current position of each draw-faders and the footage indication.

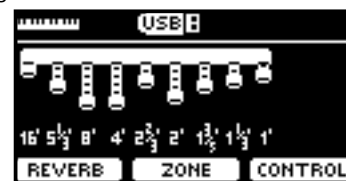

Assigning the Draw-faders (TW ASSIGN)

You can select organ sounds for the MAIN, LOWER and PEDAL keyboard parts. It's evident that only one part at a time can be assigned to the draw-faders section.

There are three buttons (MAIN, LOWER and PEDAL) that allow you to specify which keyboard part is assigned to the draw-faders section.

1. Press [MAIN], [LOWER] or [PEDAL] bottom to assigned the keyboard part to the draw-faders section.

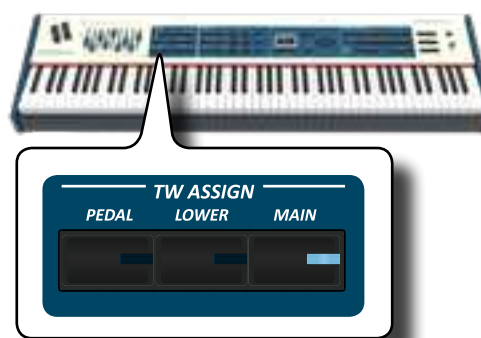

Motorised Draw-faders

The draw-faders are the heart and soul of the sound of your organ. You can change the variety of sound through the manipulation of draw-faders.

The VIVO S10 has a powerful section of draw-faders. The motorized draw-faders are always in the right position ready for immediate use in real time. This solve the common problem in every Organ Keyboard: the draw-fader position that does not change after a preset/memory call.

Altering the Sound using Draw-faders

There are nine motorised draw-faders, each of them is coupled with one footage.

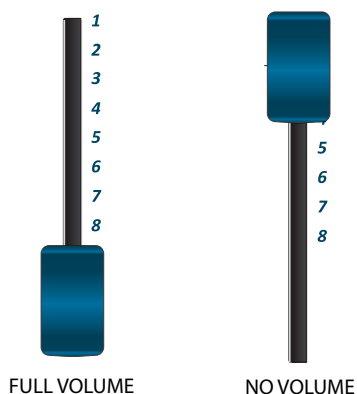

1. Move a draw-fader down to increase the volume in incremental steps from 0 (no sound) to 8 (maximum

Useful Draw-faders Movement Functions (Morphing)

By this button you can manage some useful functions related to the movement of the draw-faders.



Morphing

This function acts on the automatic movement of draw faders. There are two modes of operation:

- **AUTO** - When you recall a preset of tonewheel, the position of the draw-faders is not achieved immediately, but within a specific time.
- **PEDAL** - The transition between two different combinations of draw-faders (FROM, TO) is performed by the movement of the expression pedal connected to the "ASSIGN 3 (MORPHING)" socket. See "Connecting the Pedals" (p. 17).

Activating Morphing Function

1. Press the [MORPHING] button to activate the function. Its indicator lights.

Selecting the AUTO Mode

1. Press and hold the [MORPHING] button until the MORPHING page appears:



2. Set the "Auto" mode. See "Moving the Cursor and Setting Parameter Values" (p. 23).
3. Select the time value you want for the movement of the draw faders: Slow, Medium and Fast.

Selecting the PEDAL Mode

1. Press and hold the [MORPHING] button.
2. Set the "PEDAL" mode. See "Moving the Cursor and Setting Parameter Values" (p. 23).

The display changes as follow:



Now you can set the following parameters:

Parameter	Value	Steps
Part	Main, Lower, Pedal	3. Select the keyboard part on which the function act.
From	Draw faders position	Starting position of draw faders. 4. Select the "From" parameter and move the draw faders to set the desired "From" position.
To	Draw faders position	Destination position of draw faders 5. Select the "To" parameter and move the draw faders to set the desired "To" position.

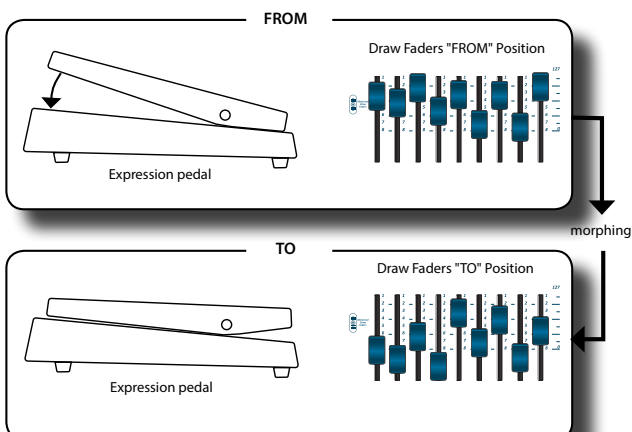

6. Moving the expression pedal from up to down, the draw faders will move gradually from the "FROM" to the "TO" combination.

MEMO

The morphing's settings can be saved in the memories. See "Working with the Memories" (p. 50).

Applying Vibrato/Chorus Effect

The VIVO S10 has a vibrato effect and a chorus effect to enrich your performances. The vibrato and chorus system consists of six settings, V1, V2, V3, C1, C2 and C3 (i.e., 3 vibrato and 3 chorus), which can be selected via the [TYPE] button.



1. Press the [ON] button to activate the effect. Its indicator lights.
2. Press the [TYPE] button to open the VIBRATO/CHORUS page and change effect.
3. Use the [DATA ENTRY] knob or the [◀] [▶] buttons to set the desired effect and depth.
4. You can press also the [TYPE] button to select the next effect.

Setting	Explanation
V1,C1	Vibrato or Chorus light depth effect
V2, C2	Vibrato or Chorus standard depth effect
V3,C3	Vibrato or Chorus deepest effect
TREMULANT 1 ~ 6	It's a characteristic effect of the pipe organ that produces a fluctuation of the amplitude and pitch of the sound, producing a tremolo and vibrato effect. NOTE This effect can be selected in the presence of an pipe organ sound.

Adding Overdrive Effect

This is the typical effect of vacuum tube amplifier and it is achieved by "overdriving" the valves.



1. Press the [OVERDRIVE] button to add overdrive effect. Its indicator lights.
The display shows the overdrive value.
2. Use the [DATA ENTRY] knob or the [◀] [▶] buttons to set the desired value.

Parameter	Setting
DRIVE	1~100

Editing Overdrive Parameter

1. Press the [OVERDRIVE] button to open the "OVERDRIVE" page.
2. Press the "EDIT" F3 function button to access the "OVERDRIVE EDIT" page.
3. You can adjust the following parameter:

Parameter	Setting	Explanation
Drive	1~100	Adjust the amount of effect. Also changes the volume.
Tone	1~100	Adjusts the tonal quality of the sound.
Level	1~100	Use this parameter to compensate for exaggerated level differences resulting from the settings you made.
Eq Low freq	80 ~ 400 Hz	Selects the frequency of the low range.
Eq Low gain	-12dB~0~12dB	Gain of the low frequency range.
Eq High freq	800Hz ~ 8KHz	Selects the frequency of the high range.
Eq High gain	-12dB~0~12dB	Gain of the high frequency range.

4. Press the [MENU/EXIT] button to come back to main page.

Adding Harmonic Percussion

It's the classic crisp attack unique to the vintage organ. This effect was designed to emulate the percussive sounds of the harp, xylophone and marimba. When the percussion is selected, this feature adds a decaying second- or third-harmonic overtone when a key is pressed.

NOTE

The harmonic percussion feature is available for the TW1 and TW2 organ type and only on the MAIN or LOWER keyboard part.

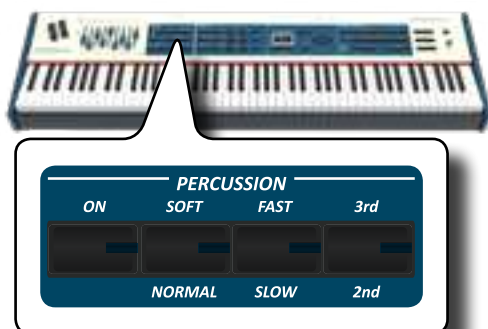

1. Press the [ON] button to add the percussion to the sound. Its indicator lights.
2. Press the [SOFT/NORMAL] button to select between a soft (the indicator lights) or hard percussion levels.
3. Press the [FAST/SLOW] button to select between a fast

(the indicator lights) or slow decay.

4. Press the [3rd/2nd] button to select between the third (the indicator lights) or second harmonics.

Adding Rotary Effect

By this section you turn it on or off the Rotary effect. This effect simulates the typical sound modulation generated by a cabinet with rotating loudspeakers.

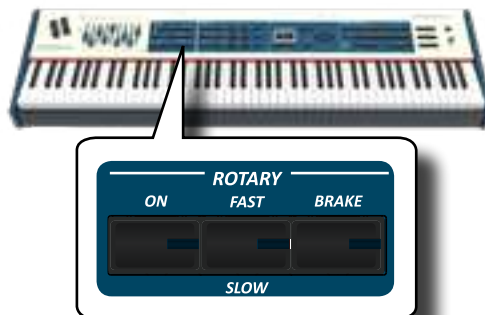

1. Press the [ON] button to add the rotary effect. Its indicator lights.
2. Press the [FAST/SLOW] button to select between the fast (the indicator lights) or slow speed.
3. Press the [BRAKE] button to stop the rotation of the rotary. When this is turned on (button's indicator lit), the rotation will gradually stop. When it is turned off, the rotation will gradually resume.

10 Adding Effects to Orchestral Sound

NOTE

This effects section is not available for the tonewheel sounds.

Going Around Sound Effects

The VIVO S10 is quite simply a superlative instrument with the most advanced and best sound generation technology Dexitell has to offer. The VIVO S10 is equipped with three units of effectors (FX-A, FX-B and FX-C) for each keyboard part (Main, Lower, Coupled and Pedal).

When you recall a Tone the instrument automatically add the appropriate effects for that sound.

Anyway, VIVO S10 give you the possibility to change type of effect or modify some parameter of it.

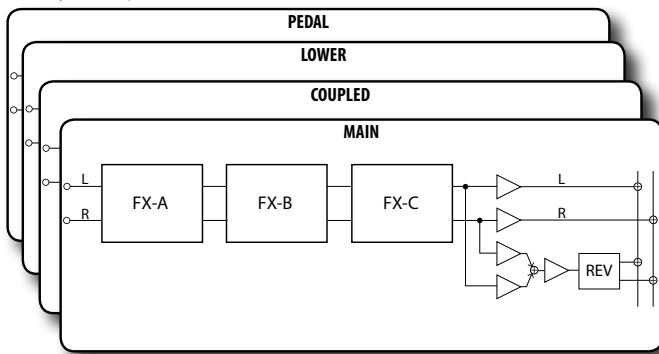

FX Real-time Controls

The VIVO S10's panel is equipped with real-time knobs to adjust the effector parameters during your live performance.

Two of the relevant parameters of the current effects are automatically assigned to the knobs: C1, C2 for the Main part, C3, C4 for the Coupled part and C5, C6 for the Lower/Pedal part.

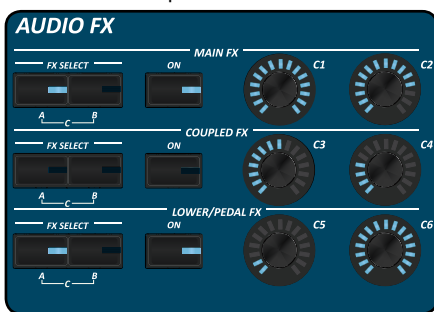

1. Use the buttons [FX SELECT A] and [FX SELECT B] of the desired part to select which AUDIO FX processor (A, B or C) you want to assign to the knobs (To select the AUDIO FX C processor, press the buttons [A] and [B] at the same time).
2. Turn the relative C1~C6 knob to adjust the amount of the assigned effect.

The display shows a temporary page with the current values and other important informations.

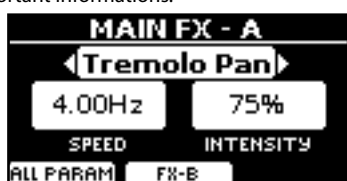

In the example above we rotated the C1 knob of the Main part. If the current sound is a tonewheel, the VIVO S10 reminds you that this section is only available for orchestral sounds.



3. Press the [ON] button if you want bypass the effect. It's indicator light off

Selecting a Sound Effect

1. Select: [MENU] button → EFFECTS. See "Moving the Cursor and Setting Parameter Values" (p. 23).

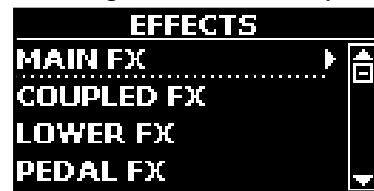

2. Use the [DATA ENTRY] knob and the button [▶] to select the part and access the related parameters.



In the example above we selected the "Main Fx".

MEMO

Instead of [DATA ENTRY] knob, You can also use the [▲] [▼] buttons to scroll the items

3. Use the [DATA ENTRY] knob to choose the Type of effect. For the list of effects see "Effects Types and Parameters List" (p. 79).
4. Use the [▲] [▼] buttons to select the parameter relative to the chosen effect.
5. Use the [DATA ENTRY] knob to adjust the parameter value. For details about the parameters for each effects, see p. "Effects Types and Parameters List" (p. 79).
6. To select the other effectors, repeatedly press the F2 function button.



Adding Reverb to the Sound

The reverb enables you to select various digital reverb effects that would add extra depth and expression to the sound to create a realistic acoustic ambience. You can adjust the reverb value for each part.

1. While the main page is displayed, press the F1 Function button to access the Reverb parameters.

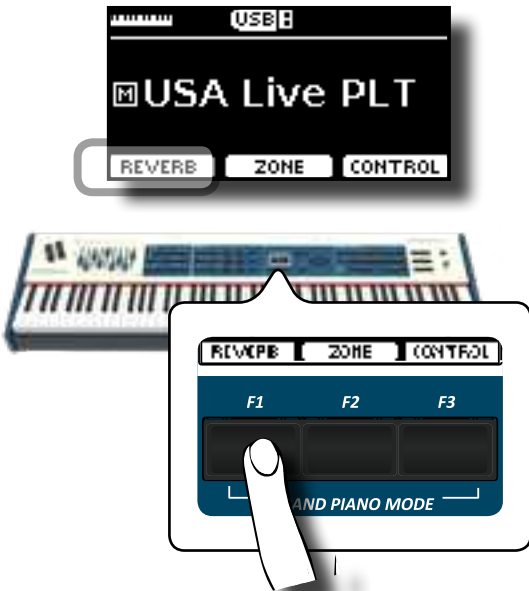

The display shows the Reverb page:



As you can see, you have an additional part, the **ORGAN** part. The ORGAN part is the part of the tonewheel. For example, if you selected a tonewheel in the Main part, to adjust the reverb you have to change the value of the ORGAN part and not the Main part.

MEMO

You can also select this function pressing [MENU] button →EFFECTS →REVERB.

2. Use the [▲] [▼] buttons to specify the part you wish to change the Reverb level.
3. Use the DATA ENTRY knob or the [◀] [▶] buttons to adjust the Reverb level.
4. Using the F1 Function button you can enable or disable the Reverb for all parts of the keyboard .



Changing the Reverb Type

This parameter allows you to specify what kind of reverb effect you need.



1. While the Reverb page is displayed, press the "TYPE" F2 Function button to access the Reverb Type page.



2. Use the DATA ENTRY knob or the [◀] [▶] buttons to choose the Macro Type you prefer.

The available Macro reverb types are:

Setting
Hall, Dark Hall, Mid Hall, Concert Hall, Large Hall, Chathedral, Arena, Cave, Chamber, Room, Venue, Ambience, Wooden Room, Brick Room, Studio Booth, Small Room, Living Room, Office, Warehouse, Music Club, Plate, Small Spring, Bright Spring, AmpSpring

Adjust the Reverb for Each Part by the Draw Faders

By the draw faders you can adjust the reverb for each part.



1. Press [MIXER] button to assign the 9 draw faders to adjust the reverb for each part.
2. You can adjust the reverb for each part moving the corresponding draw faders. On the panel, below each one of draw fader, is indicated the assigned part.

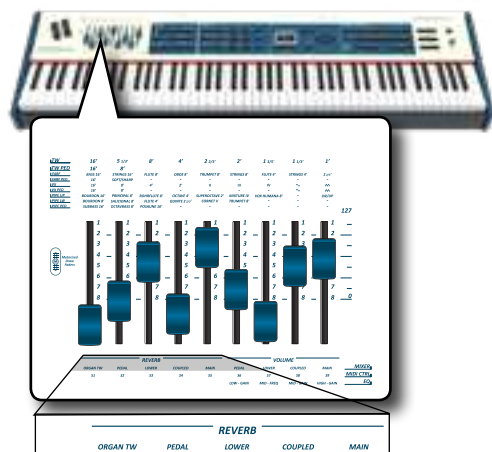

11 Other Functions

Transposing the pitch of the keyboard

The Transpose setting allows the pitch of your digital piano keyboard to be raised or lowered in semi-tone steps.

This is particularly useful when accompanying instruments tuned for different keys, or when a song learned in one key must be played in another key or when a singer sing in a key different than the original music.

1. Press the [TRANPOSE] button.



The display shown the following page.



2. Use the DATA ENTRY knob or the [◀] [▶] buttons to adjust the transposition value.

"Transpose" setting

-12 ~ 0 ~ +12 (semitone units)

If you set a value different than 0, the [TRANPOSE] button indicator lights and the keyboard is transposed.

3. Press the F1 Function button to enable or disable the transposition.

MEMO

You can also select this parameter pressing [MENU] button SETTING→TRANPOSE.

Shifting the Tuning of a Keyboard Part in Octave Steps

The Octave function is an useful parameter that allows you to change the pitch of the selected part in octave steps (12 semitones at a time).

1. Press the [OCTAVE] button.



The following page appears:



The display shown the octave value for each part.

2. Use the the [▲] [▼] buttons to select the keyboard part you want to change the octave.
3. Use the [DATA ENTRY] knob or the [◀] [▶] buttons to set the desiderate octave for the selected part.

Aftertouch

The VIVO S10 is equipped with an Aftertouch-sensitive keyboard.

Aftertouch is generated when you press a key even further down after playing a note. The aftertouch will affect to all notes playing in that keyboard part. The effect obtained is usually a filter.

1. Press the [AFTERTOUCH] button to enable the function. Its indicator lights.



Assigning a function

1. Press and hold the [AFTERTOUCH] button to open the "AFTERTOUCH" page.



2. Use the [▲] [▼] buttons to select the "Funct." (Function) parameter.
3. Use the [DATA ENTRY] knob or the [◀] [▶] buttons to set the desiderate function.

4. By the "Main", "Coupled", "Lower" and "Pedal" parameters you can choose on which part works the aftertouch.

See below the list of controls you can assign:

Control	Explanation
Aftertouch	You can control the aftertouch.
Modulation	You can control the modulation by the aftertouch.
FX Manual	You can control the FX manual of the effector by the aftertouch, see "16: Wah-Wah" (p. 81) and "17: Cut Filter" (p. 81).
Rotary S/F	The aftertouch controls: <ul style="list-style-type: none"> • the TW Rotary slow/fast if an organ sound (tonewheel) is selected. • the FX Rotary Speed of the effector if an orchestral sound is selected. See "12: Rotary" (p. 80).

Performing Musical Chords

VIVO S10 is equipped with two chord features: Chord Enhancer and Chord Freeze.

Chord Enhancer

This function improve the sound plays automatic harmonies that are added to the chord that you are playing using the Main, Coupled and/or Lower part.

The Chord Enhancer function works when a tone of the Strings, Choir, Brass or Pad family is selected and the function is active (CHORD [ENHANCER] button indicator is lit). To know which tones you can use, see the "VIVO S10's Tone List" (p. 82).

1. For example, select a tone of the String, Choir, Brass or Pad family on the Main part. See "How to Select Tones" (p. 24).

Same behavior if at the point (1) you selected a tone for the Lower part.

2. Press the CHORD [ENHANCER] button.

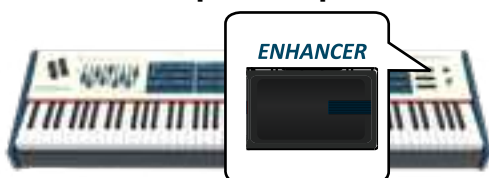

The [ENHANCER] button indicator lights and the Chord Enhancer function is active.

NOTE

If the current selected tone is not a tone of the Strings, Choir, Brass or Pad family, the Enhancer function is disabled.

3. Play a chord on the keyboard.

The Chord Enhancer function adds notes to the chord you played.

4. Press the CHORD [ENHANCER] button to leave this function.

Chord Freeze

If you need to play the same complex chord and play it quickly in different tonality on the keyboard, this is your function.

The Chord Freeze allows you to memorize a complex chord and play it in different tonality on the keyboard using a finger only.

MEMO

The Chord Freeze function is only available for the Main and Coupled keyboard parts.

1. Playing and holding the chord (at least two notes) on the keyboard that you want "Freeze", press the CHORD [FREEZE] button.



The chord is memorized and the CHORD [FREEZE] indicator lights.

2. Play a note on the keyboard with the desired tonality.

The chord previously memorized is reproduced with the same tonality of the played note.

You can now on until the function is active play the chord using one finger.

3. If you need to memorize another chord:

- a. Press the CHORD [FREEZE] button to leave the function.
- b. Playing and holding the new chord, press the CHORD [FREEZE] button.

The chord is now memorized and you can play it as before.

4. Press the CHORD [FREEZE] button to leave this function.

5. If during your performance you need to use the same chord, you don't need to memorize it again. Without pressing any keys on the keyboard, press the CHORD [FREEZE] button to enable the function.

Adjusting the Keyboard Response (Key Touch)

This parameter is only for the orchestral sounds. As you know, the organ sounds have fixed dynamics.

If you selected an orchestral sounds and the keyboard response don't meet your taste, you can adjust it. You can choose until to five dynamic response.

1. Press [MENU/EXIT] button and select SETTING→KEYBOARD TOUCH function. See "Moving the Cursor and Setting Parameter Values" (p. 23).
2. Use the [DATA ENTRY] knob or the [◀] [▶] buttons to choose your desiderate dynamic response.

The following settings are available:

Setting	Value	Explanation
Keyboard Touch	Light++	"Heavy" range: Select this setting for maximum expressiveness. Even small variations of the force with which you strike a key produce audible changes. The trade-off is, however, that you have to strike the keys forcefully to reach the maximum volume.
	Light+	
	Light	
	Normal	"Normal": Medium velocity sensitivity. The keyboard responds to velocity changes, but the maximum volume can be obtained more easily than with "Hard".
	Heavy	"Light" range: Select this settings if you do not want velocity changes to bring about major volume changes.
	Heavy+	
	Heavy++	
Fixed [1~127]		
*Fixed Value	1~127	Allows you to set the value when "Curve" is set to "Fixed".

[*] This parameter can only be edited if the "Keyboard Touch" parameter is set to "Fixed".

Customize the Global Keyboard Response (Key Touch)

We have previously seen how you can choose the keyboard response from 7 predefined curves: Heavy ++, Heavy+, Heavy, Normal, Light, Light+, Light++. Here below we will see how to modify the velocity curve as you wish, starting from one of the preset curves.

1. Press [MENU/EXIT] button and select SETTING→KEYBOARD TOUCH function. See "Moving the Cursor and Setting

Parameter Values" (p. 23).

The following page is shown.



2. Use the [DATA ENTRY] knob or the [◀] [▶] buttons to choose your desired dynamic response.
3. To customize the velocity curve press the F1 Function button.
4. Use the [◀] [▶] buttons to select one of the 5 points that characterize the curve: "pp", "p", "mf", "f", "ff".
5. Use the [▲] [▼] buttons to modify the value of the selected point.

Curve Point	Explanation
	"pp" standing for <i>pianissimo</i> and meaning "very soft".
	"p" standing for <i>piano</i> and meaning "soft".
	"mf" standing for <i>mezzo-forte</i> and meaning "half loud".
	"f" standing for <i>forte</i> and meaning "loud".
	"ff" standing for <i>fortissimo</i> and meaning "very loud".

6. Use the "RESET" Function button to restore the point at the default value.
Your velocity curve is automatically saved in the global area when the instrument is turned off.

Adjusting the AUDIO IN Input Level

The input level of the audio source you connect can be set with the "AUDIO INPUT Level" parameter.

1. Press [MENU/EXIT] button and select AUDIO INPUT function using the [▲], [▼] and [▶] buttons. See "Moving the Cursor and Setting Parameter Values" (p. 23).



2. Use the [DATA ENTRY] knob or the [◀] [▶] buttons to adjust your desired the AUDIO IN level.

Specifying the Audio Output for Each Part

VIVO S10 provides MAIN/SUB unbalanced output (TS jacks) in addition to MAIN balanced output (XLR jacks) as outputs for the signal of the audio parts.

As appropriate for your situation, you can choose which audio output to use (MAIN or SUB) for a certain part (Organ, Main, Coupled, Lower and Pedal).

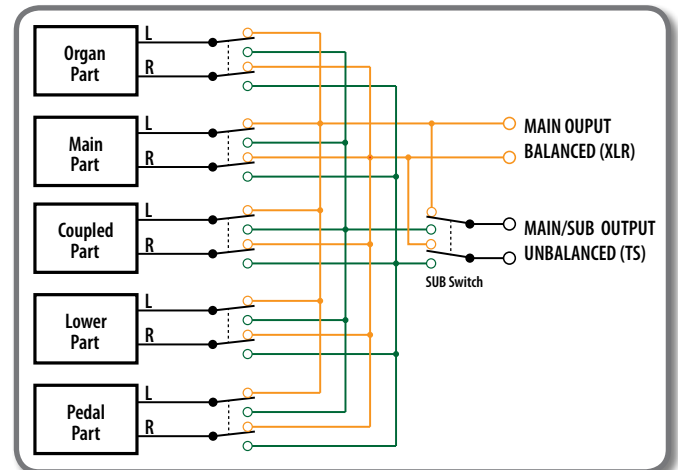

1. Select: [MENU] button → OUTPUT. See "Moving the Cursor and Setting Parameter Values" (p. 23).

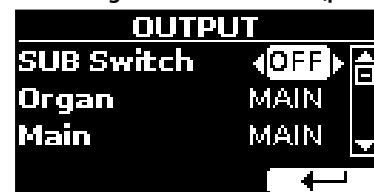

2. Use the [▲] [▼] buttons to select "SUB Switch" parameter and using the [DATA ENTRY] knob set the "SUB Switch" parameter to "ON".
The MAIN/SUB unbalanced sockets are now enabled as SUB audio outputs.
3. Use the [▲] [▼] buttons to select the part you wish to change the output.
4. Use the [DATA ENTRY] knob to set the desired output (MAIN or SUB).

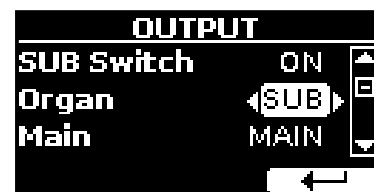

In the example above we changed the output of the Organ part.

5. By performing steps 2 and 3 again you can change the output of the parts you want.

Parameter	Setting	Explanation
SUB Switch	OFF, ON default: OFF	Enable the MAIN/SUB unbalanced sockets as SUB outputs.

Parameter	Setting	Explanation
Organ	MAIN, SUB default: MAIN	Use this parameter to set the audio output of the part: MAIN or SUB
Main		
Coupled		
Lower		
Pedal		

How to Protect Your Settings, Contents and Sounds List (Backup)

You can back up contents, settings, and sounds list from your VIVO S10 into a USB Memory.

This function is also useful before sending your instrument for repair.

1. Press [MENU/EXIT] button and select the BACKUP function. See "Moving the Cursor and Setting Parameter Values" (p. 23).

The following page appears:



Backup Your Settings, Contents and Sounds List

1. Connect the USB Memory to which you wish to save your data. See "Connecting an USB Memory (commercially available)" (p. 19).
2. Select the "EXPORT BACKUP" function. See "Moving the Cursor and Setting Parameter Values" (p. 23).

The following page appears:



3. If you want to name your backup, see "Assigning the Name You Specify" (p. 23) for details.
4. Press the "OK" Function button to perform the function.

The following data are saved:

Backup Data
Global Parameters
Master Eq User Parameters
Memory Parameters
Memory Set Parameters
MIDI Set User Parameters
Temperament User Scale Parameters
Sound Library List

Restore Your Settings, Contents and Sounds List

1. Connect the USB Memory that contains the data. See "Connecting an USB Memory (commercially available)" (p. 19).
2. Select the "IMPORT BACKUP" function. See "Moving the Cursor and Setting Parameter Values" (p. 23).

Restoring the Factory Settings (Factory Reset)

The following function allows you to recall the VIVO S10's original factory settings.

WARNING

All data will be deleted. Backup your own settings to an USB memory.

1. Press [MENU/EXIT] button and select FACTORY RESET function. See "Moving the Cursor and Setting Parameter Values" (p. 23).

The display shows the following window.



2. Press the "YES" Function button proceed.

The message "Complete" informs you that the VIVO S10 has been initialized.

NOTE

The Factory Reset function doesn't initialize the Global Area.

Restore the Factory Sounds

Using this function you can restore all sound libraries as they came out of the factory.

1. Press [MENU/EXIT] button and select FACTORY SOUND function. See "Moving the Cursor and Setting Parameter Values" (p. 23).

The following page appears:



2. Press the "YES" Function button proceed.

The message "Complete" informs you that the VIVO S10 Sound Libraries has been restored.

If you no longer want to restore the sound libraries, press the "NO" Function button

The contents of the USB memory are displayed:

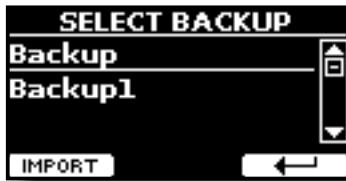

3. Use the [▲][▼] to select the backup data you want.
4. Press the "IMPORT" Function button to perform the function.

The following page appears:



5. Press the "YES" function button to proceed.
All data will be restored.

Panic Function

Use this function if some operation on your instrument or an external tone generator (connected via a MIDI or USB cable) has caused strange sounds or stuck some notes.

1. Press [MENU/EXIT] button and use the [▲][▼] to select the PANIC function.



2. Press the [▶] button to perform the function.
"All notes off" and "Reset All Controllers" messages are send to your VIVO S10 sound generator and on all MIDI channels of an possibility connected sound generator.

12 Additional Sound (Sound Library)

What is a Sound Library?

The sound (patch) in the DEXIBELL's devices is composed of several oscillators that reproduce waveforms. The patch contains also information about Pitch,/TVA,/TVF envelope, filters and so on. All this and more contributes to shapes the sound.

A Sound library contains sounds that use the same waveforms. For example, the "Electric Piano" library, contains the following sounds: Dyno Stage, Suitcase, Phaser EP, etc.

Sound Library Memory Structure

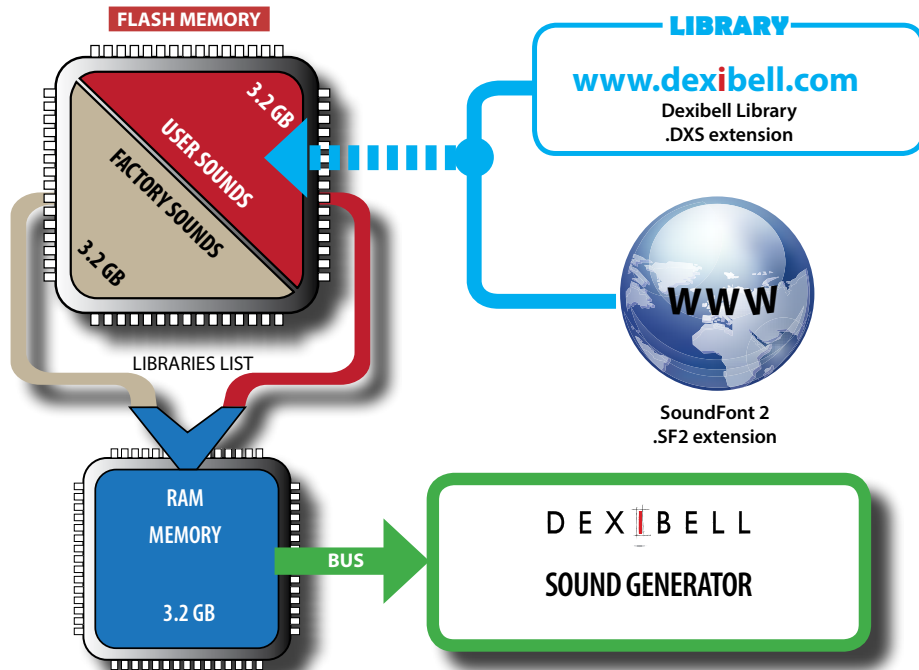

The VIVO S10's Internal Flash Memory contains the Sound Libraries. This memory is divided into two parts of 3.2 GB:

- the first part, not erasable, contains the Factory Libraries.
- the second part, programmable, can contain the User Sound Libraries.

Using the list of libraries to load, at the power on, the VIVO S10 load the sound libraries from the Internal Flash Memory into the Internal RAM of 3.2 GB. At default, the list contains the Factory Libraries only.

You can load the new libraries into the User Sound area by taking them from the DEXIBELL library (www.dexibell.com) or from third-party sounds (.SF2 extension).

By a programmable list you can choose which sound libraries (User or Factory or part of them) to load in the RAM Internal Memory. You can decide to completely replace the factory sounds loading all sound from the User sounds area or decide to load a part of the sounds from the factory area and another from the User area.

Sound Library

VIVO S10 gives you the possibility to install new sounds from:

- DEXIBELL Official Sounds (.DXS extension)

These sounds will be available and downloadable from the following website:

<http://www.dexibell.com/>

Stay tuned for new sounds and updates by visiting our website regularly!

- third-party sounds (.SF2 extension)

You can easy found in the web many sounds library with .SF2 extension. VIVO S10 is compatible with these types of sounds.

Factory area ("INTERNAL ARCHIVE") ready to be reloaded again. See "Recovery a Library from the "INTERNAL ARCHIVE"" (p. 42) and "Restore the Factory Sounds" (p. 38).

1. Press the [SOUND LIBRARY] button to open the "SOUND LIBRARY" page.



A page like this appears:





The list of the Sound Libraries in the internal Memory are showed. You can note, at the left of each library name, a icons:

Remove and Add Sound Libraries

In the "SOUND LIBRARY" page you can decide which libraries load into the RAM area.

NOTE

The removed libraries are not deleted. They remain in the

Icon	Explanation
	The library sound comes from the Factory Sound libraries.
	The library sound comes from the User Sound libraries.

At the bottom of the screen you can recall two functions: "REMOVE" and "ADD". Here below, we will explain how to remove or add sound libraries.

Removing a Sound Library



1. Use the [DATA ENTRY] knob or the [▲] [▼] buttons to select the sound library you want to temporary remove.
2. If you want to know the sounds contained in the library, press the [▶] button to open it.



3. If you want to listen the sounds of the library, use the [DATA ENTRY] knob or the [▲] [▼] buttons to select the sound and activate notes by the keyboard of the VIVO S10.
4. From the "SOUND LIBRARY" page, press the "REMOVE" F1 Function button to perform the removal.

The display shows:

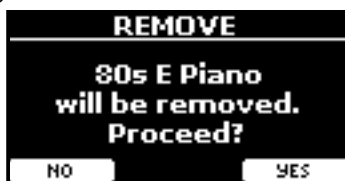

5. Press the "YES" Function button to perform the removal. Press "NO" if you no longer want to perform the function.

NOTE ABOUT THE REMOVAL OF SOUND LIBRARIES

- **Factory libraries** - The factory libraries are not deleted but are removed from the list of libraries to load at startup.
- **User Sound libraries** . The User Sound libraries are permanently deleted. Make sure to have a backup, if you think you need them again.

How To Load Sound Libraries in a USB Memory

You can import sounds library in the User Sound memory of VIVO S10 and use them in your performances. To import them you need an USB

Memory and your Personal computer.

Loading a sounds library in a USB Memory

1. Using your computer, download the new sound library from the DEXIBELL web site (.DXS) or from any other web site (.SF2).
2. Create a folder "SOUND" in the root of the USB Memory.
3. Copy the sound library (.DXS/.SF2) into the USB Memory's "/SOUND" folder.
4. Insert the USB Memory into the VIVO S10 USB port. See "Connecting an USB Memory (commercially available)" (p. 19).
5. See "Adding a Library from USB Memory" (p. 41) to import the sound library.

Adding a Library



1. Press the "ADD" F2 Function button to add a library.

The display shows the libraries previous removed:

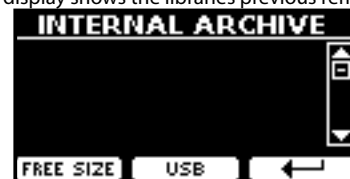

In the example above, the list of removed libraries is empty (no libraries has been previously deleted). In this case you can add only libraries from an USB Memory previously loaded.

The following example shows that some libraries was removed and the list of "INTERNAL ARCHIVE" shows which they are:



2. If you want get information about the RAM Internal free memory, press the "FREE SIZE" F1 Function button.



The page shows the RAM Internal memory available express in MB and percent.

This function is useful to know how much available free memory you have to load new libraries.

Adding a Library from USB Memory

1. To load the library into your USB Memory, please refer to "Loading a sounds library in a USB Memory" (p. 41).

- Insert the USB Memory into the USB port of the VIVO S10.
- From the "INTERNAL ARCHIVE" page, press the "USB" Function button to list the sound libraries in the USB Memory.

The following page is showed:



The instrument shows the sound libraries contained in the USB Memory's "\SOUND" folder.

MEMO

To navigate inside the folders use the [▶] button to open a folder and the [◀] button to return to a higher level.

Press the "INTERNAL" Function button to return to viewing the internal archive.

- Use the [DATA ENTRY] knob or the [▲][▼] buttons to select the sound library you prefer.
- To open the sound library, press the [▶] button.

The sound/sounds contained in the library are displayed.



- Use the [DATA ENTRY] knob or the [▲][▼] buttons to select the sounds and listen them by the keyboard. If the sounds are to your liking, you can import the library into the internal memory.
- if you want to know the size of the library, press the "INFO" F2 Function button.



- Press the "IMPORT ALL" Function button to import the sound library. The instrument asks you in which sound family you want to import the library:



- Use the [DATA ENTRY] knob or the [▶][◀] buttons to select in which sound family you want to import the library.
- Press the "EXECUTE" F1 Function button to perform the function.

A confirmation message informs you that the sound library has been imported.

Recovery a Library from the "INTERNAL ARCHIVE"

Thanks to this function you can reload previously removed internal libraries.



- Use the [DATA ENTRY] knob or the [▲][▼] buttons to select the library you want reload into internal memory.

- To open the sound library, press the [▶] button.

The sound/sounds contained in the library are displayed.



- Use the [DATA ENTRY] knob or the [▲][▼] buttons to select the sounds and listen them by the keyboard.

If the sound is to your liking, you can import the library into the internal memory.

- if you want to know the size of the library, press the "INFO" F2 Function button.



- Press the "IMPORT ALL" F1 Function button to import the sound library.

The instrument asks you in which sound family you want to import the library:



- Use the [DATA ENTRY] knob or the [▶][◀] buttons to select in which sound family you want to import the library.

- Press the "EXECUTE" F1 Function button to perform the function.

A confirmation message informs you that the sound library has been imported.

How to Restore the Factory Sound
See "Restore the Factory Sounds" (p. 38).

How to Select USER Sounds

The VIVO S10 has two memory areas.

The first area, divided in USER1 and USER2, is selectable from the [ORGAN TYPE] button.

The second area is selectable from the [USER] button in the orchestral sounds selection panel.

To select a User sound, please see "Selecting Various Organ Types" (p. 29).

How to Select USER Organ Sounds

Before to select a USER sound, you need to import sounds. Please see "How To Load Sound Libraries in a USB Memory" (p. 41).

1. Repeatedly press the [ORGAN TYPE] button until the indicator select the USER1 or USER 2 type organ.

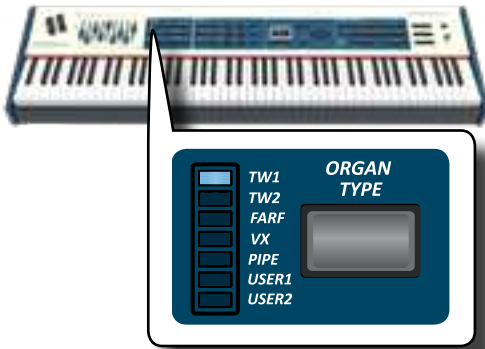

2. If a Tonewheel is not already selected, you need to select one of them. If the [SOUND] button is not already lit, press it to enable the nine family and number buttons to select tones.



3. Press the [TW ORGAN] button to select the tonewheel organ family.

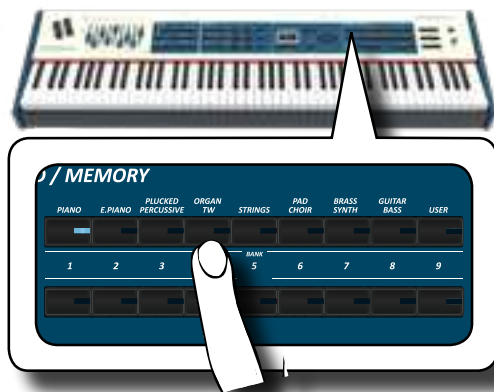

The display shows the list of the tonewheel preset.

4. Press the desiderate [1 ~ 9] Sound button to select the User preset.

How to Select USER Orchestral Sounds

Before to select a USER sound, you need to import sounds. Please see "How To Load Sound Libraries in a USB Memory" (p. 41)..

1. If the [SOUND] button is not already lit, press it to enable the nine family and number buttons to select tones.



2. Press the "USER" button.

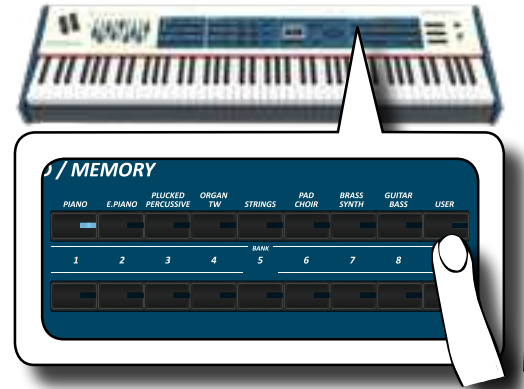

The last sound you selected s recalled.

The button indicator lights and a temporary window shows the list of User tones where the recalled sound is underlined:



3. Press the desiderate [1 ~ 9] Sound button to select a User sound.

The User sound is selected and the window highlight you the name of the sound. After few seconds of inactivity of the change sound operation, the Main page is shown.

4. The User sounds are arranged in pages of 9 sounds. While the sound window is active, press the [◀] [▶] buttons to select the previous or next tone User page. After few seconds of inactivity of the change tone operation, the Main page is shown.

TIPS

A quick way to change a tone from the Main page: use the [◀] [▶] buttons to select a next or previous sound in the same category.

13 Sound Setup (Export/Import)

This is a useful function that allows you to prepare a sound set for a performance. If, in a performance, you will use only piano sounds, you can create a Sound Set that contain only piano sounds. In this way you can use the maximum size of internal memory of the module for piano sounds.

At your convenience, you can also download sound sets from the <http://www.dexibell.com/> website.

Exporting a Sound Set ("EXPORT SETUP")

This function export the sound set, that you have previously prepared, in a USB Memory.

1. Prepare your Sound Set using the functions previously explained: "ADD" and "REMOVE". See "Remove and Add Sound Libraries" (p. 40).
2. Insert a USB Memory into the USB port of your instrument.
3. Press the [MENU/EXIT] button and use the [DATA ENTRY] knob or the [▲][▼] buttons to select the "SOUND SETUP" function group.



The "SOUND SET" page appears:



4. Use the [DATA ENTRY] knob or the [▲][▼] buttons to select "EXPORT SETUP" and press the [▶] button to access the function.

The display changes to:



5. If you want to name your Sound Set, please see "Assigning the Name You Specify" (p. 23).
6. Press the "OK" Function button to save your Set.
A confirmation message is temporarily showed.

Importing a Sound Set ("IMPORT SETUP")

This function import the sound set previously saved in a USB Memory.

NOTE

Before to import a Sound Set take in consideration that your current Sound Set, in the internal memory, will be replace.

You can lost external sound libraries previously loaded from a USB Memory. Regarding the internal sound libraries no problem, You can recover them in the "INTERNAL ARCHIVE". See "Adding a Library" (p. 41).

1. Insert a USB Memory that contains previously saved Sound Set into the USB port of your instrument.
2. Press the [MENU/EXIT] button and use the [DATA ENTRY] knob or the [▲][▼] buttons to select the "SOUND SETUP" function group.



The "SOUND SET" page appears:



3. Use the [DATA ENTRY] knob or the [▲][▼] buttons to select "IMPORT SETUP" and press the [▶] button to access the function.

The display shows the list of the Sound Set in the USB Memory:

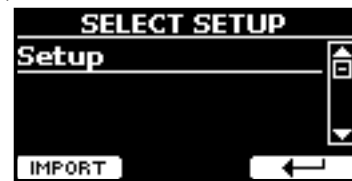

4. Use the [DATA ENTRY] knob or the [▲][▼] buttons to select the Sound Set.
5. Press the "IMPORT" F1 Function button to load the Sound Set.
A confirmation message is temporarily showed.

14 Personalizing Your Sounds (T2L)

T2L-Modelling



The revolutionary technology found on all models of DEXIBELL keyboards. T2L-Modelling is the combination of innovative technologies developed to achieve maximum timbre accuracy and precise sound responsiveness.

T2L modelling has many algorithms that simulate all the characteristics of an acoustic piano. It take care of many aspect as:

No Damper ("No Damper" on high notes)

The last 18 higher notes, like in the acoustic instrument, do not have the presence of the dampers and then are free to vibrate even when keys are released.

The duration of these notes, playing in staccato mode, is much longer than the previous notes that instead have the presence of the damper.

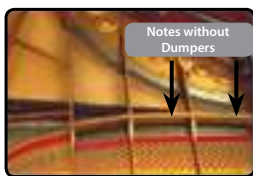

FP-Simulation ("DAMPER Pedal" multi actions simulation)

The "DAMPER" Pedal (Sustain), performs several actions that are simulated through this function.

A) When the "DAMPER" pedal is pressed, a sound is generated to simulate the damper friction noises of felts when releasing from the strings (Damper Friction Noise).

B) Pressing the "DAMPER" pedal, the active notes will be enriched with resonances produced by all strings free to vibrate, thanks to the raised dampers (Strings Resonance). The result of the Strings Resonance makes the sound of a sustained note by the use of the "DAMPER" pedal substantially different from the sound of a just held note.

C) When the "DAMPER" pedal is released, a noise is simulated like the mechanical noise in the acoustic instrument (Sustain Pedal Mechanical Noise).



(A) & (B) "DAMPER" pedal is pressed, felt dampers are raised.



(C) "DAMPER" pedal is released, felt dampers are resting on strings.

See "DAMPER PEDAL" (p. 70).

SP-Simulation ("Soft Pedal" Simulation)

The "Soft" Pedal, acts a change of volume and timbre color of the sound, simulating the "soft" function on the acoustic piano.



Soft Pedal

You can change many sound parameters at will.

Making Slight Additions or Sound Alterations

Although Dexibell sound are developed to achieve the maximum sound accuracy, you can necessity to modify them at your taste them or create new sonority.

Take note that the parameters of the sound you want modify are of the part (Main, Coupled, Lower, Pedal). This means that the same sound modified for the Main part will sound different if selected from the Coupled part

1. Select the sound that you want personalize. See "How to Select USER Sounds" (p. 42).
2. Press the [T2L] button to access the Editor functions.

MEMO

You can also select this function pressing [MENU] button → T2L EDITOR.



3. Use the [DATA ENTRY] knob or the [▲] [▼] buttons to select in which part you want modify the sound.

The display shows the Editor sound page that contains all possible parameters for the tone you selected:

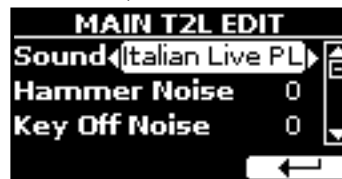

In the example above the VIVO Grand piano was selected.

4. Use the [▲] [▼] buttons to select the parameter you wish to modify.
5. Use the [DATA ENTRY] knob or the [◀] [▶] buttons to adjust the value.

Saving your changing

All you need to do is to save your setting in a memory. See "Working with the Memories" (p. 50).

Parameters to be edited

The parameter list depends on the characteristics of the selected sound.

Orchestral Sounds Parameters

VIVO S10 allows you to personalize the tones by adjusting various factors that affect the sound.

Each Tone has available a number of parameters that allow you to personalize the sound.

Hammer-Noise (Key On impulsive Noises) (for Ac. Piano)



Attack of notes contains an impulsive portion of sound produced by the hit of the Hammer to the strings, amplified and sustained by the resonance of the piano body. A function is available to reduce/increment this element of the sound.

Parameter	Setting
Hammer Noise	-64 ~ 0 ~ +63

Key Off Noise (Key Off Mechanical Noises) (for Ac. Piano)

The release of keys causes mechanical noises proportional to the speed of the release itself. This behavior of the acoustic instrument is reproduced by this function

Parameter	Setting
Key Off Noise	-64 ~ 0 ~ +63

Damper Noise (for Ac. Piano)

This is the typical noise of an acoustic piano when the pedal sustain is pressed (lift all dampers) or released (lower all dampers).



Dampers

Parameter	Setting
Damper Noise	-64 ~ 0 ~ +63

String Reso (Sympathetic Harmonic Resonances) (for Ac. Piano)

As in the acoustic Piano, while holding down some keys and playing other notes in staccato mode, a multitude of additional harmonics can be listened, thanks to "sympathetic resonance" generated by the free to vibrate strings (due to raised dampers) of the held notes.

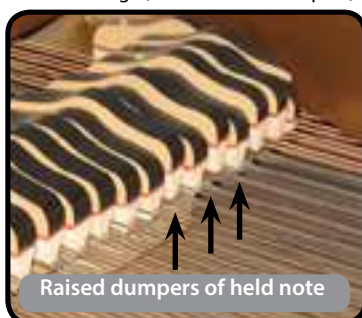

Raised dampers of held note

Parameter	Setting
String Reso	-64 ~ 0 ~ +63

Damper Reso (for Ac. Piano)

It's the typical noise generated by the free to vibrate strings (all damper raised) when the damper pedal is pressed.

Parameter	Setting
Damper Reso	-64 ~ 0 ~ +63

Cabinet Reso (for Wurly, Ac. Guitar, and Harp)

Thanks to this parameter you can increase or decrease the cabinet resonance.

Parameter	Setting
Cabinet Reso	-64 ~ 0 ~ +63

Bell (for Electric Piano)

The "bell sound" is characteristic of some electric pianos that became particularly popular throughout the 1970s.

You can adjust the quantity of this typical sound.

Parameter	Setting
Bell	-64 ~ 0 ~ +63

Growl (for Electric Piano)

This is a typical distortion of the sound during the phase attack that give a "growling" effect. Thank to this parameter you can increase or decrease the effect.

Parameter	Setting
Growl	-64 ~ 0 ~ +63

Off Noise (for Clavinet, Harpsi, E. Piano, Bass)

You can adjust the quantity of the noise effect that some instrument produce when the key is released.

Parameter	Setting
Off Noise	-64 ~ 0 ~ +63

On Noise (for Trumpet, Flugelhorn)

This parameter adjust the quantity of the noise of the trumpet when the piston is pressed.

Parameter	Setting
On Noise	-64 ~ 0 ~ +63

Attack, Hold, Decay, Sustain and Release (For Brass, Strings, Pad, Choir, Synth, Jazz Guitar)

These parameters characterize the envelope of the sound. For example, when an organ key is pressed, it plays a note at constant volume; the sound dies quickly when the key is released. By contrast, the sound of a guitar is loudest immediately after a string is plucked, and quickly fades. Try to change the envelope of a sound by these parameters.

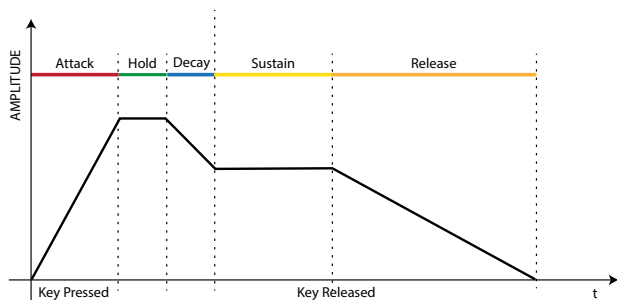

Parameter	Setting
Attack	
Hold	
Decay	
Sustain	-64 ~ 0 ~ +63
Release	
Cutoff	
Resonance	

The envelope (Attak, Hold, Decay, Sustain and Release) aren't limited to controlling just volume (amplitude) but, in some instruments as Strings, Pad, Choir and Synth, it controls some filter parameters such as Cutoff and Resonace. You can determine the frequency at which the filter starts working (Cutoff) and how much it "boosts" the frequencies around the cutoff frequency.

Ride

This parameter increase or decrease the volume of Ride Cymbals sound contained in the "Ac. Bass&Ride" tone.

Parameter	Setting
Ride	-64 ~ 0 ~ +63

Amp noise

This parameter simulates the noise of the bass amplifier.

Parameter	Setting
Amp noise	-64 ~ 0 ~ +63

String noise

This parameter simulates the resonance of the bass strings.

Parameter	Setting
String noise	-64 ~ 0 ~ +63

Key Noise

This parameter simulates the noise of Saxophone Key.

Parameter	Setting
Key noise	-64 ~ 0 ~ +63

Polyphonic

This parameter becomes useful when you use some solo instruments like flute, violin, saxophone, trumpet and accordion.

Parameter	Setting	Explanation
Polyphonic	Low, High, Last, Poly	<p>Low - The part becomes monophonic and play the leftmost note you played.</p> <p>High - The part becomes monophonic and play the rightmost note you played.</p> <p>Last - The part plays monophonic.</p> <p>Poly - The part plays polyphonic.</p>

Blow

Blowing is possibly the most important part of any woodwind instrument. This parameter adjusts the amount of blowing in a flute sound.

Parameter	Setting
Blow	-64 ~ 0 ~ +63

Pluck

This parameter is used to emphasize the sounds of "Pedal Bass" e "Pedal DoubleBs". It works to emphasize the attack phase of the sound.

Parameter	Setting
Pluck	-64 ~ 0 ~ +63

TW Organ Sound Parameters

Use [ORGAN TYPE] button to change the organ type: TW1, TW2, FARF, VX and PIPE.

For details see "Selecting Various Organ Types" (p. 29).

Percussion

This effect was designed to emulate the percussive sounds of the harp, xylophone and marimba. It's the classic crisp attack unique to the vintage organ.

For details see "Adding Harmonic Percussion" (p. 32).

Vibrato/Chorus

The vibrato and chorus system consists of six settings, V1, V2, V3, C1, C2 and C3 (i.e., 3 vibrato and 3 chorus).

For details see "Applying Vibrato/Chorus Effect" (p. 31).

Overdrive

This is the typical effect of vacuum tube amplifier and it is achieved by "overdriving" the valves.

For details see "Adding Overdrive Effect" (p. 31).

Organ Common

Volume

This parameter reduce the volume of the tonewheel. When you set the "Soft" value the volume of the tonewheel became slightly softer in volume and equalization.

Parameter	Setting
Volume	Normal, Soft

Leakage

In the vintage electro-mechanical organs, sometimes the signal from adjacent tonewheels causes pickups to overhear tonewheels other than their own. This noise, originally considered to be a defect, grew to be an integral part of the electro-mechanical organ sound. Use this parameter to modify the amount of leakage.

Parameter	Setting
Leakage	0 ~ 127

Hum noise

The sound of the organ is produced by an electro-magnetic pick-up. So some hum is normal and unavoidable in an electro-mechanical organ. If you think you suffer from excessive hum, you can modify the level.

Parameter	Setting
Hum noise	0 ~ 127

Click On Noise and Click Off Noise

Some electro-mechanical organs have an audible pop or click when a key is pressed or released. Originally, key click was considered a design defect and the designers worked to eliminate or at least reduce it with equalization filters. Over time has become a characteristic part of the sound and it has been accepted as part of the classic sound. Use this parameter to adjust the amount of click noise.

Parameter	Setting
Click On Noise	0 ~ 127
Click Off Noise	

Perc. Manual

It's the classic crisp attack unique to the vintage organ. See "Adding Harmonic Percussion" (p. 32). The percussion is a typical register in the Main manual. With this parameter, you can choose which part of the keyboard (MAIN or LOWER) to add the percussion effect.

Parameter	Setting
Perc. Manual	Main, Lower

Expression Min

The expression pedal is an important control for many musical instruments including organs. Use this parameter to set the minimum value of the expression when the pedal is lifted.

Parameter	Setting
Expression Min	0 ~ 127

Express. Tone

When the volume falls, the sound of the high or low frequencies becomes difficult to hear. When this parameter is set to "On", when the volume falls, the low frequency are less attenuated than Mid/high frequencies.

Parameter	Setting
Express. Tone	Off, On

Brilliance

This parameter is enabled when you select a Pipe organ type. You can adjust the brightness of sound.

Parameter	Setting
Brilliance	-12 ~ +12

Rotary Parameters

Rotary Block Diagram

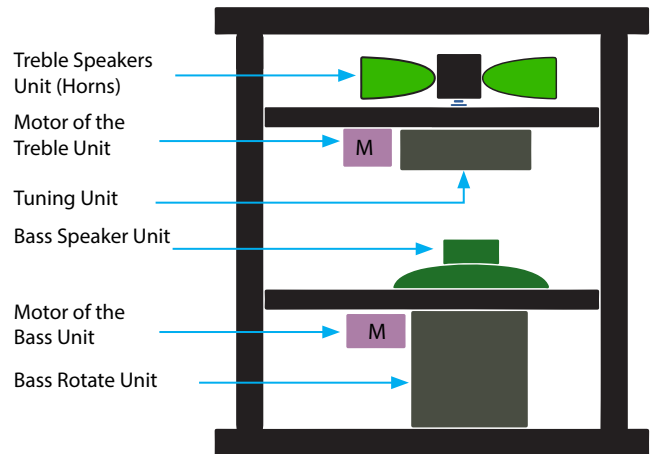

Rotary Type

This parameter determines the mode of rotation.

Parameter	Setting	Explanation
Rotary Type	A, B	<p>A: Normal simulation.</p> <p>B: Advanced simulation. Already introduced on J7 and S9 with previous OS 4.06, this effect is our latest generation of Rotary Speaker effect conceived with a new algorithm that makes the entire depth and the simulation of the horn and bass speakers rotations even more truthful. Accelerations and decelerations are so accurate that you have the perception to virtually see the moving speakers adding this essential character to your organ performances.</p>

Rotary Noise

This is the noise when the motor is running. Use this parameter to adjust the amount of the noise.

Parameter	Setting
Rotary Noise	0 ~ 127

Horn Slow RPM and Horn Fast RPM

These parameters adjust the speed of the horn rotor at the slow and fast mode.

Parameter	Setting
Horn Slow RPM	20 ~ 100
Horn Fast RPM	300 ~ 500

Horn RampUp and Horn RampDw

These parameters set the time for the horn rotors to "ramp up" and to "ramp down" when switching from slow to fast (Horn RampUp) or when switching from fast to slow (Horn RampDw).

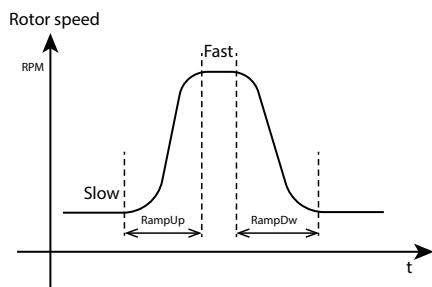

Parameter	Setting
Horn RampUp	0.2 ~ 15 sec.
Horn Ramp Down	

Bass Slow RPM and Bass Fast RPM

These parameters adjust the speed of the bass rotor at the slow and fast mode.

Parameter	Setting
Bass Slow RPM	20 ~ 100
Bass Fast RPM	300 ~ 500

Bass RampUp and Bass RampDw

These parameters set the time for the bass rotors to "ramp up" and to "ramp down" when switching from slow to fast (Bass RampUp) or when switching from fast to slow (Bass RampDw).

Parameter	Setting
Bass RampUp	0.2 ~ 15 sec.
Bass RampDw	



- Use the [▲] [▼] buttons to select one of the three parameters available.
- Use the [◀] [▶] buttons to adjust the parameter you selected.

Parameter	Setting	Explanation
Start	0~127	It is the starting point of the velocity curve where you want to operate with the compression or expansion.
Rate	0.1~8.0	It is the compression/expansion coefficient that you want to use.
Offset	0~127	It's the minimum value of velocity.

In the example below you can see that the Start point was set to 52, the "Offset" starts from the value 35 and the rate was set to 2.7.

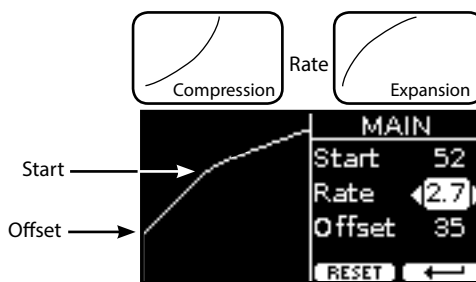

- Press the "RESET" Function button to restore the parameters at the default value.

Adjusting the Keyboard Velocity Response According to the Sound

NOTE

Only for orchestral sound.

By the "Velocity Compend" function in the T2L MENU, you can adjust the keyboard velocity for each orchestral sound. You can choose to expand the velocity of a Piano sound and compress the velocity of a strings or Pad sound.

- Please refer to the "Making Slight Additions or Sound Alterations" (p. 45) to access the "T2L EDITOR" functions. How to select the keyboard part and the sound to edit it.
- In the example below we selected the sound of the Main part. Use the [DATA ENTRY] knob or the [▲] [▼] buttons to move the cursor under the "Velocity Compend" function.



- Press the button [▶] to access the function.
The following page appears:

15 Working with the Memories

Using the Memories is a lot faster than calling up one of the VIVO S10's functions, modifying the settings, etc., while playing.

The instrument provides some Memories (81 memories) that allow you to store almost all settings (or registrations) you make on the front panel and the various display pages. Additional Memories can be imported directly from a USB Memory.

About the Memories and Memory Set structure.

The Memories you create are saved in the internal Memory Set or in an external Memory Set previously saved in the USB Memory. This allows you to prepare one set of Memories for weddings, another for corporate events, a third for anniversaries, etc.

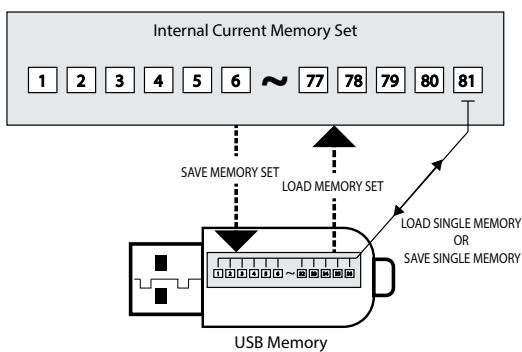

Saving Your Settings in the Internal Memory

1. Change all settings the way you want to save them.
For details on settings memorized, see p. 67.
2. Press and hold the [MEMORY/WRITE] button.

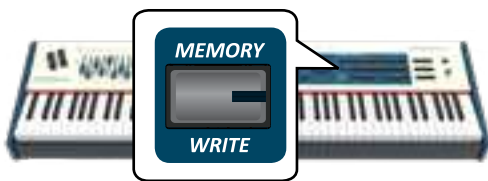

The display shows:



The [MEMORY/WRITE] button indicator lights and the list of Internal Memory is shown.

MEMO

You can also select this function pressing [MENU] button →MEMORY→WRITE.

3. Use the bank (Sound Families) and number buttons to select the position you want to replace the Memory.
You can also use the [▲][▼] buttons to move the cursor inside the list to select the Memory you want to replace.
4. Press the "SAVE" Function button to confirm.

The display changes to:



5. If you want to name your new Memory, see "Assigning the Name You Specify" (p. 23) for details.
6. Press the "OK" Function button to save the Memory.
The memory will be saved and the list of Internal Memory is shown.



Recalling your Settings from Internal Memory

1. Press the [MEMORY/WRITE] button.
The [MEMORY/WRITE] button indicator lights steady and the list of Internal Memory is shown.



MEMO

You can also select this function pressing [MENU] button →MEMORY→RECALL.

2. Use the bank (Sound Families) and number buttons to recall the Memory you want.
You can also use the [DATA ENTRY] or the [▲][▼] buttons to move the cursor inside the list to select the Memory you want to recall and press the "RECALL" Function button.
The Memory is recalled and the display shows the Memory highlighted.



How to Rearrange the Order of Memories

Use this function if you need to rearrange your Memories in a different order.

3. Press the [MENU/EXIT] button and select MEMORY→REORDER.

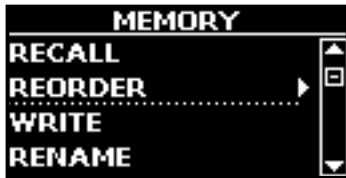

The display shows a list of Memories.



- Use the [▲][▼] buttons to move the cursor inside the list to select the Memory you want to reorder and press the "MOVE" function button.

An  symbol appears to the left of the selected Memory.



- Use the [▲][▼] buttons to select the new position where you want to move the selected Memory.



- Press the "OK" Function button to confirm the operation.
Press "CANCEL" Function button to cancel the operation

Saving Your Settings in the USB Memory (commercially available)

- Connect the USB Memory to which you wish to save the Memory. See "Connecting an USB Memory (commercially available)" (p. 19).
- Change all settings the way you want to save them.
- Press and hold the [MEMORY/WRITE] button until the display shows:



The list of Internal Memory is shown.

MEMO

You can also select this function pressing [MENU] button
→MEMORY→WRITE.

- Press the [USB] Function button to select the destination

memory.

The display shows a list of all files and folders on the USB storage device you have just connected.



Now you can save:

- In a Memory Set previously saved. Continue from step (5)
- In a new Memory Set. See "Saving in a New Memory Set" below.

Saving in a Memory Set previously saved

- Use the [DATA ENTRY] or the [▲][▼] buttons to scroll through files and folders to select the Memory Set.

Memory Set Icon	Memory Set file extension
	.rif

Use the "OPEN" Function button if you need to enter in a folder.

If you opened a folder by mistake, press the [←] button to return to a higher level.

- Press the "OPEN" Function button to recall the Memory Set.

The display shows the list of memories in the Memory Set.



- Use the bank (Sound Families) and number buttons to select the position you want to replace the Memory.

You can also use the [DATA ENTRY] or the [▲][▼] buttons to move the cursor inside the list to select the the Memory Set you want to save and press the "SAVE" Function button.

- Press the "SAVE" Function button to confirm.

The display changes to:



The name of the current memory is suggested.

- If you want to name your new Memory, see "Assigning the Name You Specify" (p. 23) for details.

- Press the "OK" Function button to save the Memory.

The memory will be saved and the list of memories is shown.



Saving in a New Memory Set

1. Press the "NEW SET" Function button to create an empty Memory Set.

This page allows you to create a new Memory Set List whose name is selected automatically by the VIVO S10.



2. If you want to name your new Memory Set, see "Assigning the Name You Specify" (p. 23) for details.
3. Press the "OK" Function button to confirm the name. The display shows contents of the new Set just created.



4. Use the bank (Sound Families) and number buttons to select the position you want to write the Memory. You can also use the [DATA ENTRY] or the [▲][▼] buttons to move the cursor inside the list to select the position of the memory you want to save and press the "SAVE" Function button.
5. Press the "SAVE" Function to confirm. The display changes to:



The name of the current memory is suggested.

6. If you want to name your new Memory, see "Assigning the Name You Specify" (p. 23) for details.
7. Press the "OK" Function button to save the Memory. The memory will be saved and the list of Memories is shown.



Recalling your settings from an USB Memory

1. Connect the USB Memory to which you wish to save the Memory. See "Connecting an USB Memory (commercially available)" (p. 19). A USB icon appears in the Icons field of Main page. See "Main Page" (p. 22).

2. Press the [MEMORY/WRITE] button. The [MEMORY/WRITE] button indicator lights steady and the list of Internal Memory is shown.



MEMO

You can also select this function pressing [MENU] button →MEMORY→RECALL.

3. Press the "USB" Function button. The display shows a list of all files and folders on the USB storage device you have just connected.



4. Use the [▲][▼] buttons to scroll through files and folders to select the Memory Set.

Memory Set Icon	Memory Set file extension
	.rif

Use the "OPEN" Function Button to enter in a folder.

If you opened a folder by mistake, press the [←] button to return to a higher level.

5. Press the "OPEN" Function button to open the selected Memory Set. The display shows the list of Memories:



6. Use the bank (Sound Families) and number buttons to recall the Memory you want. You can also use the [DATA ENTRY] or the [▲][▼] buttons to move the cursor inside the list to select the Memory you want to recall.
7. Press the "RECALL" Function button to recall the Memory. The Memory is recalled and the display shows the Memory highlighted.

**MEMO**

To display the Internal Memories again, press the "INTERNAL" Function button.

Renaming a Memory

This function allows you to change the name of a Memory.

1. Press the [MENU] button and select MEMORY→RENAME.

The list of Internal Memory is shown:

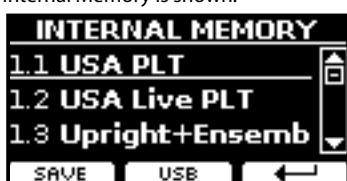

2. Use the the [DATA ENTRY] or [▲][▼] buttons to move the cursor inside the list in the position you want to rename the Memory.

3. Press the "RENAME" Function button to confirm.

The display changes to:



4. Use the [DATA ENTRY] knob and the [◀][▶] buttons to rename the Memory. See "Assigning the Name You Specify" (p. 23) for details.

5. Press the "OK" Function button to confirm the name.

The memory will be renamed and the list of Internal Memory is shown.



Exporting a Memory Set in the USB Memory

Set in the USB Memory (commercially available).

This function is useful to create special sets for each event and import them at your convenience.

You can also use this function to backup the Internal Memories.

1. Connect an USB memory to the VIVO S10. For details see p.19.

An USB icon appears in the Icons field of Main page. See "Main Page" (p. 22).

2. Press the [MENU] button and select MEMORY→EXPORT SET.



The display shows a list of all files and folders on the USB storage device you have just connected.



3. Use the [DATA ENTRY] or the [▲][▼] buttons to scroll through folders to select the destination folder.

Use the "OPEN" Function button to enter in a folder.

If you opened a folder by mistake, press the [←] button to return to a higher level.

4. Press the "EXPORT" Function button to confirm your selection.

The display changes to:



A Memory Set name is suggested by the VIVO S10.

5. If you want to name the Memory Set, see "Assigning the Name You Specify" (p. 23).
6. Press the "OK" Function button to export the Memory Set.

A message confirm the operation.

NOTE

You should always safely eject the USB Memory before physically unplugging it from USB socket. Before to unplug the USB Memory use the "USB REMOVE" function. See "Safely Remove the USB Memory" (p. 20).

Importing a Memory Set from the USB Memory.

Use this function for importing Sets from the USB Memory (commercially available) to Internal Memory.

1. Connect an USB memory that contains Memory Sets to the VIVO S10. For details see p.19.

An USB icon appears in the Icons field of Main page. See "Main Page" (p. 22).

2. Press the [MENU] button and select MEMORY→IMPORT SET.

The display shows a list of all files and folders on the USB storage device you have just connected.



- Use the [DATA ENTRY] or the [▲][▼] buttons to scroll through folders to select the Memory Set to import.



Use the "OPEN" Function button to enter in a folder.
If you opened a folder by mistake, press the [←] button to return to a higher level.

- Press the "IMPORT" Function button to confirm your selection.

A message confirm that the Memory Set was imported.

NOTE

You should always safely eject the USB Memory before physically unplugging it from USB socket. Before to unplug the USB Memory use the "USB REMOVE" function. See "Safely Remove the USB Memory" (p. 20).

How to Automatically Recall Your Favorite Setting at the Power On.

The VIVO S10 give you the possibility to have your favorite setting directly at the startup of the instrument. To do this, follow the procedure below:

- Set all the parameters you want when you turn on the instrument.
- Press the [MENU] button and select MEMORY→SAVE AS DEFAULT.



The instrument asks you if you want your settings as default.



- Press the "Yes" Function button to confirm the operation. Press "No" to quit the function.

Deleting a Memory Set

Use this function to delete a Memory Set from an USB Memory.

- Press the [MENU] button and select MEMORY→DELETE SET.



The display shows a list of all files and folders on the USB storage device you have just connected.



- Use the [DATA ENTRY] or the [▲][▼] buttons to move the cursor inside the list in the position you want to delete the Memory Set.



- Press the "DELETE" Function button to delete the selected Memory Set.

A message confirm the operation.

How to Customize the Grand Piano Mode

As seen in the "Selecting Tones" chapter, we can easy recall the best piano sound pressing simultaneously the first and last Function button from the Main page. See "Grand Piano Mode" (p. 24).

Through the "SAVE AS G.P. MODE" function we can save our own setting and recall it when entering the "Grand Piano Mode".

- Modify the sound and all the parameters you want for the "Grand Piano Mode".
- Press the [MENU] button and select MEMORY→SAVE AS G.P. MODE.



The instrument asks you if you want to save your "Grand Piano Mode".



- Press the "Yes" Function button to confirm the operation. Press "No" to quit the function.

16 Playing a Music Audio File

The VIVO S10 can play back audio files in the mp3 and WAV formats directly from a USB memory you connect to its USB MEMORY port.

You can play along a backing song.

The VIVO S10 can play back the following file types:

File Type	Extension
Audio files	.mp3
	.wav
	.aiff or .aif

Before Playing Songs

Before being able to play back audio (mp3 or WAV) on the VIVO S10, you must load songs into an USB Memory.

For performing these operations you need a personal computer.

Copying Audio Files to an USB Memory

1. Insert your USB Memory into the USB socket of your computer.
2. Copy all audio files into the USB Memory.

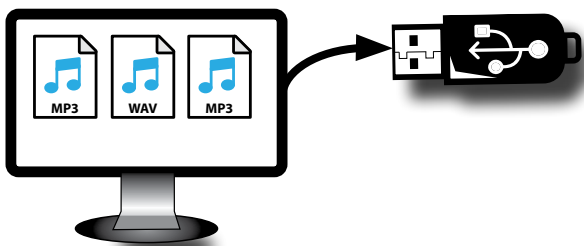

3. Disconnect your USB Memory safely.

Selecting and Playing a Song

1. Insert an USB Memory that contains songs. See "Connecting an USB Memory (commercially available)" (p. 19) and see "Before Playing Songs" (p. 55).

Select the song

2. Press the [SONG] button to enter in SONG mode.

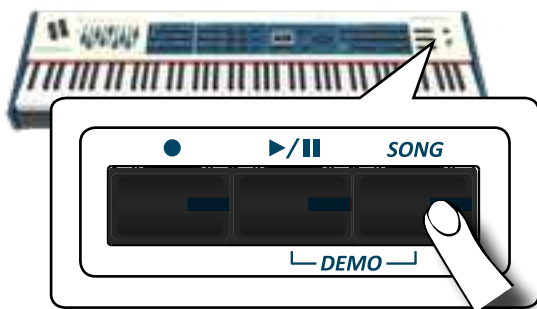

The display shows the Song main page and the name of the current song is shown if already loaded.



3. Press the "SONG LIST" function button. The display shows the contents of the Song internal memory.



4. Press the "USB" function button if you want to select a song into the USB memory. The display shows the contents of the USB memory.



5. Use the [DATA ENTRY] or the [▲][▼] buttons to scroll through files and folders.
6. If the song you need is located inside a folder, you must first select that folder, press the "OPEN" Function button to see its contents and then select the song. If you opened a folder by mistake, press the "←" Function button to return to a higher level.
7. Press the "SELECT" Function button to load the song you want to play.



The song icon is highlighted to indicate the song selected.

Play the song

8. Press the [▶/||] button.
The [▶/||] button's indicator lights and song playback starts.
9. Press the [▶/||] button again to pause song playback.
The [▶/||] button goes dark.
10. Press [▶/||] again to resume playback.
11. If you want to go back to the beginning of the current song, from the Player main page press the [◀] function button.



- From the Player main page, turn the [DATA ENTRY/SONG VOLUME] knob to adjust the volume of song playback.

The song level page is temporarily shown:



MEMO

The [DATA ENTRY/SONG VOLUME] knob when a parameter is selected works as Data Entry. In all other cases this knob allows you to set the volume of the song player.

Parameter	Value	Explanation
Loop Mode	OFF, SONG, LIST	"OFF": No loops. Playback stops at the end of the selected song current.
		"SONG": Continuously repeats playback of the current selected song. The playback is repeated until select a different song or stop the song playback.
		"LIST": Continuously repeats playback of all music files available in a folder, in consecutive order. The playback is repeated until select a different song or stop the song playback.

How to Rename or Remove Songs on a USB Memory (Song Explorer)

VIVO S10 has useful files navigation function (Song Explorer) that allow you to rename or remove a previously-saved song on a USB Memory.

- Press the [MENU] button and select USB MEMORY→SONG EXPLORER.



The display shows a list of all songs and folders on the USB Memory you have just connected.



- Use the [DATA ENTRY] or the [▲][▼] buttons to move the cursor inside the list to select the song to be renamed or deleted.

To navigate inside the folders use the "OPEN" function button and the [↵] button function to return to a higher level.

Removing a Song

Here's how to delete a song that you saved on an USB Memory.



- Press the [REMOVE] function button to delete the song.

A message confirm the operation.

Useful Song Controls

VIVO S10 has useful song controls that allow you to adjust the volume, rewind or fast-forward within the currently selected song, etc.

- Load the song you want to play back. See "Selecting and Playing a Song" (p. 55).



- From the Player main page, press the "CONTROL" Function button.

The display shows:



- Use the [▲][▼] buttons select the control parameter.
- Use the [◀][▶] buttons to choose your setting.

Parameter	Value	Explanation
Volume	0~127	Adjust the Volume of the song player. You can directly adjust the song volume by the [DATA ENTRY/SONG VOLUME] knob.
Time	It depends on the duration of the song	<ul style="list-style-type: none"> Press the [◀] to rewind within the song Press the [▶] to fast-forward within the song

Renaming a Song

Here's how to rename a previously-saved song.



4. Press the [RENAME] function button to rename the song.

The display changes to:



5. Use the [DATA ENTRY] knob and the [◀] [▶] buttons to rename the song. See "Assigning the Name You Specify" (p. 23) for details.
6. Press the "OK" Function button to confirm the name.
The file is renamed and the list of songs is shown.

17 Recording Your Performance

The VIVO S10 allows you to record your performance and save it to an USB storage device.

Recording as Audio Data

Your performance will be recorded as audio data. The recorded song can be used on your computer, phone and in any audio player.

NOTE

To use this method of recording, you must connect an USB drive (sold separately) to the USB Memory port (p. 19).

Recording Your Music as Audio Data (WAVE).

This useful function allows professional quality stereo recordings.

You can reproduce directly by a portable music player by using a computer.

Recording are saved in the external USB Memory (commercially available).

In addition, the VIVO S10 allows you to record everything that is connected to the AUDIO IN socket. You can reproduce a backing audio track by an external player connected to the AUDIO IN socket, play along with your instrument in order to practice and then record your performance.

NOTE

- You will need an USB Memory (commercially available) to record your performance.

Audio Recorder format specifications

Audio Format	Specification
WAV	48 kHz, 32 bit, Stereo

Before you start recording

1. Connect the USB Memory to which you wish to save the audio data. See "Connecting an USB Memory (commercially available)" (p. 19).
2. Prepare everything you want to record: select the tone and the keyboard mode that you want to use for performing.

Starting/stopping recording

3. Press the [●] (Rec) button to start recording.
The indicator of the [●] button lights and the VIVO S10 starts to recording everything you play on the keyboard.
4. At the end of the song, press the [●] (Rec) button to stop recording.
The recording stops and the [●] (Rec) button lights off.
Your audio file is saved to the "Recording" folder on the USB memory.

NOTE

Do not disconnect the USB Memory during the song recording.

About the Recording Files

The audio files are saved in the "Recording" folder on the USB Memory.

If the "Recording" folder doesn't exist, it is automatically created within the first recording.



The songs are saved with a different progressive number: rec_0001.wav, rec_0002.wav and so on.

Listening to your recording

5. Press the [▶/||] button to listen to your song.

If you want to re-record again, repeat from step 3.

NOTE

You should always safely eject the USB Memory before physically unplugging it from USB socket. Before to unplug the USB Memory use the "USB REMOVE" function. See "Safely Remove the USB Memory" (p. 20).

How to Record your Performance over an Existing Audio Song (Overdub)

This is a technique used in audio recording. is a process that allows performances to be recorded synchronously with pre recorded materia. All is recorded in a new song.

1. Connect the USB Memory to which you wish to save the audio data. See "Connecting an USB Memory (commercially available)" (p. 19).
2. Prepare everything you want to record.
3. Load a existing audio song. See "Select the song" (p. 55).
4. Press the [●] (Rec) button to start recording.
5. Press the [▶/||] button to start the playback of the audio song pre-recorded.
6. Play your performance while listening to the audio song pre-recorded.
7. At the end of song, press the [●] (Rec) button to stop recording.
The recording stop and the [●] indicator lights off.
8. Press the [▶/||] button to listen your new song.

18 Master Keyboard Zone

The VIVO S10 is also designed to be used as a Master Keyboard. Using the [MASTER KEBOARD ZONE] buttons you can divide the keyboard into up four zones with separate MIDI channels and other associated settings so that you can control multiple parts of an external devices at the same time.

The illustration below shows an example of a 4-zone configuration. A zone refers to a specific key range on the keyboard.

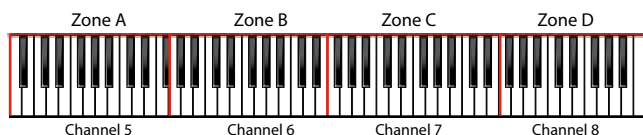

You can connect directly your VIVO S10 to an external device by the USB bus or by the MIDI socket. See "Connecting the VIVO S10 to Your Computer" (p. 18) or "Connecting the VIVO S10 to MIDI devices" (p. 19). You can use many commercial software application for sequencing, notation and so on.

Programmable Four MIDI zones

VIVO S10 has four programmable separated MIDI zones. For each zone you can select the MIDI channel, the keyboard range, adjust the Octave, Transpose and many other parameters.

MEMO

The zone settings can be saved in the memories. See "Working with the Memories" (p. 50).

MEMO

To facilitate the MIDI settings using the zones, you have a special MIDI SET called "KeyboardZone". Please see "MIDI SET" (p. 77).

1. To enable a zone, press the relative [A], [B], [C], [D] button.

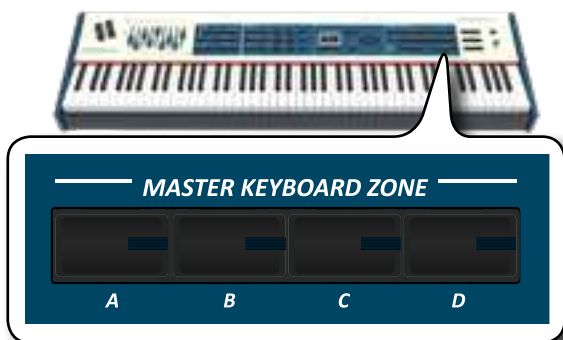

Its indicator lights and the zone is enabled. The MIDI information of the key pressed in the enables zone is sent to the external device.

To disable the zone press the relative zone button.

MEMO

Each zone can overlap to one another.

Configure the MIDI zones

1. Press and hold the button relative to the zone you want to edit.



In the example we selected the zone A.

MEMO

You can also select this function pressing [MENU] button → ZONE and then pressing the EDIT function button (F2).

2. Use the [▲][▼] buttons to select the parameter.
3. Use the [DATA ENTRY] knob or the [◀][▶] buttons to adjust the value.

Here is a brief explanation of MIDI zone configuration parameters:

Parameter	Setting	Explanation
Switch	OFF, ON	Disable or enable the MIDI zone.
Channel	1~16	Select the MIDI transmit channel.
Octave	-4 ~ 0 ~ +4	Adjust the Octave value.
Transpose	-12 ~ 0 ~ +12	Adjust the Transpose value.
Note Low	A-0 ~ B-7	Set the keyboard range.
Note High	B ^b -0 ~ C-8	MEMO An easy way to set the range, - Select the parameter (Note Low or Note High). - Press a key on the keyboard.
CC00	0 ~ 127	These messages are used to select a sound on the external device when you active the zone.
CC32	0 ~ 127	
PC	1 ~ 128	Select the triplet (cc00, cc32, PC) to define the sound.
Level	0 ~ 127	Set the volume level to send to the external device.
Panpot	-64 ~ 0 ~ 63	Set the panpot value to send to the external device.
Reverb	0 ~ 127	Set the Reverber value to send to the external device.
PC Send	OFF, ON	OFF: use this setting if you do not want the triplet (cc00, cc32, PC) is sent via MIDI. ON: use this setting to send the triplet (cc00, cc32, PC) via MIDI.
Level Send	OFF, ON	OFF: the volume message is not sent via MIDI. ON: the volume message is sent via MIDI.
Panpot Send	OFF, ON	OFF: the panpot message is not sent via MIDI. ON: the panpot message is sent via MIDI.
Reverb Send	OFF, ON	OFF: the reverb message is not sent via MIDI. ON: the reverb message is sent via MIDI.
Bender	OFF, ON	OFF: The bender wheel is decoupled. ON: The bender wheel is coupled with the zone. The bender values are transmitted via MIDI.
Modulation	OFF, ON	OFF: The modulation wheel is decoupled. ON: The modulation wheel is coupled with the zone. The modulation values are transmitted via MIDI.
Aftertouch	OFF, ON	OFF: The aftertouch is decoupled. ON: The aftertouch is coupled with the zone. The aftertouch values are transmitted via MIDI.

Parameter	Setting	Explanation
Foot SW	OFF, ON	<p>OFF: The function of the pedal is decoupled.</p> <p>ON: The function linked to the pedal is coupled with the zone. The values are transmitted via MIDI.</p>
Damper	OFF, ON	
Expression	OFF, ON	
Morphing	OFF, ON	
C1~ C6	OFF, ON	<p>These parameters are related to the six control knobs located on the "AUDIO FX" panel.</p> <p>OFF: The control knob is decoupled.</p> <p>ON: The control knob is coupled with the zone when the MIDI channel is set to "Zone". See "CONTROL 1/2/3/4/5/6" (p. 72). The values are transmitted via MIDI.</p>
S1 ~ S9	OFF, ON	<p>These parameters are related to the nine sliders (draw-fader).</p> <p>OFF: The slider is decoupled.</p> <p>ON: The slider knob is coupled with the zone when the MIDI channel is set to "Zone". See "SLIDER 1, 2, 3, 4, 5, 6, 7, 8, 9" (p. 72). The values are transmitted via MIDI.</p>
CC Assign1	OFF, CC1 ~ CC127	<p>These four control change messages are available to be transmitted to the external device when the zone is activated.</p> <p>OFF: No control change is transmitted.</p> <p>CC1 ~ CC127: Select the control change to send via MIDI.</p> <p>0 ~ 127: Select the value.</p>
CC Value 1	0 ~ 127	
CC Assign2	OFF, CC1 ~ CC127	
CC Value 2	0 ~ 127	
CC Assign3	OFF, CC1 ~ CC127	
CC Value 3	0 ~ 127	
CC Assign4	OFF, CC1 ~ CC127	
CC Value 4	0 ~ 127	

19 Playing with Audio Backing Tracks

Thanks to X MURE® application and the VIVO S10 you can play your favourite melodies while controlling an audio pattern.



X MURE® is a DEXIBELL® software product

WHAT IS X MURE

- X-MURE is an application that runs on iPhone or iPad.
- Using "Harmony Poly Fragmentor" (the world first algorithm able to modify "audio tracks" in real time), "X MURE" allows you to play music directly on the screen of your iPad/iPhone or with a musical instrument connected via USB.
- "X MURE" does not use sound generators, virtual instruments or "Standard MIDI file", it is exclusively based on audio tracks recorded by real musical instruments, so it does not simulate reality... it is the reality.

WHAT YOU CAN DO WITH X MURE

- Control X MURE audio patterns by live chord progression played by the VIVO S10.
- Re-arrange your favourite music tracks using countless musical genres or create a completely new song hit.

WHAT YOU NEED TO USE X MURE

- The VIVO S10 Digital Organ.
- Apple iPad Camera Connection Kit (Camera connectors made by Apple Inc.).
- USB cable (type A-male - type B-male: commercially available).
- Audio cable (3.5 mm jacks).
- Download X MURE application from App Store.

Connecting your Mobile Device

1. Connect your iPad with your VIVO S10 by using a USB iPad camera connector and a USB cable.

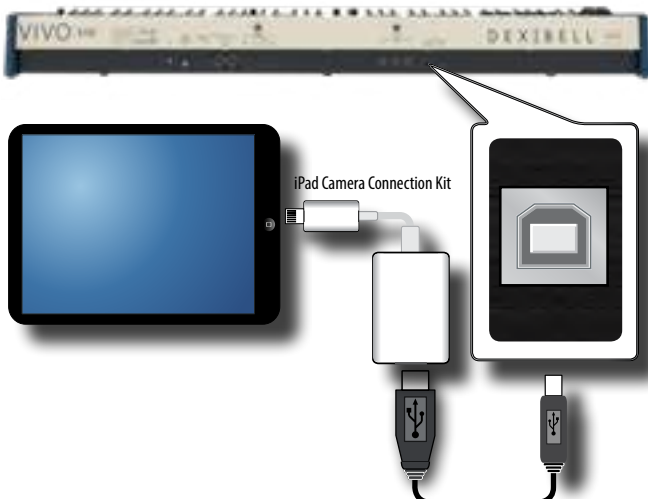

2. Rotate the [VOLUME] knob toward the lower position to minimize the volume.
3. Connect the VIVO S10's INPUT jack positioned to the rear panel to the output socket of your mobile device. See "Connecting Digital Player Devices" (p. 18).

Playing with X MURE Application

1. Turn your VIVO S10 and your iPad on.
2. Touch the X MURE icon in your iPad to open the app.

Now you have three possible choices:



3. Touch Dexibell VIVO icon to have the maximum performance with VIVO S10.

The following page appears:



4. Play a note in the keyboard to inform X MURE which part you want use to control it.
5. On X MURE select the audio pattern you want play back.
6. Touch the play icon of the X MURE application.

The pattern start to play back.

MEMO

You can use a pedal to Play or Stop the play back of the pattern. See "CONTROL" (p. 70).

7. Play chords in the keyboard. The audio pattern follows your chord progression.
8. On X MURE touch the "A", "B", "C", "D" icon button to chose a different scene.

MEMO

You can use a pedal to select different scene. See "CONTROL" (p. 70).

9. On X MURE touch the "1", "2", "3", "4" icon button to chose a different drum pattern.

MEMO

You can use a pedal to select different drum pattern. See "CONTROL" (p. 70).

Bluetooth® Audio and MIDI Connectivity

VIVO S10 is equipped with Audio and MIDI Bluetooth® (4.2 Low Energy) function.

Thanks to this technology, you'll be able to:

- Listen to music played from your smartphone or tablet through the VIVO S8M speakers or through the VIVO S10 audio output sockets.
- Exchange MIDI data between the mobile device and the VIVO S10.



Connecting with the Mobile Device

The first time you use a new mobile device, you need to "pair" it with your device so that both devices know how to connect securely to each other.



NOTE

Please take in consideration that the our explanation to pair your mobile device with the VIVO S10 is as an example. The operations to pair your mobile device can be different and depend on the operating system of your device. For details, please refer to the owner's manual of mobile device.

1. Place the mobile device within 1 meter (3 ft) from the VIVO S10.

NOTE

When pairing, make sure that other devices are off or out of range.

2. Make sure that VIVO S10 is visible to other devices. See "Turning on the VIVO S10's Bluetooth® Functions" (p. 62).
3. On the mobile device that you want to connect, turn on the Bluetooth® function and, if necessary, search for the available devices.



For details on how to enable the Bluetooth® function, refer to the owner's manual of your mobile device.

The list of available devices is now shown in your mobile device.

4. Select the "Dexi-piano-xx" device that is shown in the Bluetooth® list of your mobile device.



In example above the device name is "dexi-piano-BF".

5. If the mobile device and the VIVO S10 ask you to confirm the connection showing the "passkey" screen, confirm before on VIVO S10 and then on your mobile device.



When pairing succeeds "dexi-piano-xx" is added to the list of paired

Turning on the VIVO S10's Bluetooth® Functions

1. press the [MENU] button and select Bluetooth® page.



2. Use the [▲][▼] buttons to select the "Visible" parameter.
3. Use the [◀][▶] buttons to set it "On".

The VIVO S10 is now visible to other devices:



devices in the mobile device. Viceversa the mobile device is added to the list of "Paired" devices of VIVO S10.



6. Select the "Dexi-piano-xx" device that is shown in the paired devices list of your mobile device.

MEMO

For details, refer to the owner's manual of your mobile device.

MEMO

Once the devices have been paired, there is no need to perform pairing again. Once the device is recognized, the VIVO S10 ask you to authorize the connection:



Choose "YES" to authorize the connection. The following page appears:



The connection is now established and a Bluetooth® icon is shown in the main menu. The music data played back by the mobile device can be heard through VIVO S10.

NOTE

Pairing is required again if you execute a Factory Reset (p. 38).

Connecting an Already Paired Mobile Device

NOTE

Please take in consideration that the explanation to connect your mobile device with the VIVO S10 is as an example. The operations to connect your mobile device can be different from our explanation and depend on the operating system of your device. For details, please refer to the owner's manual of your mobile device.

1. Place the mobile device within 1 meter (3 ft) from the VIVO S10.
2. If necessary, turn on the Bluetooth® function on the mobile device.
3. Select the "Dexi-piano-xx" device that is shown in the Bluetooth® list of your mobile device.

MEMO

For details, refer to the owner's manual of your mobile device.

Using Bluetooth® Audio

You can listen to the music played on your mobile device through the speakers of the VIVO S8M or through external amplified speakers connected to the audio outputs of the VIVO S10. See "Connecting External Audio Amplifier" (p. 17).

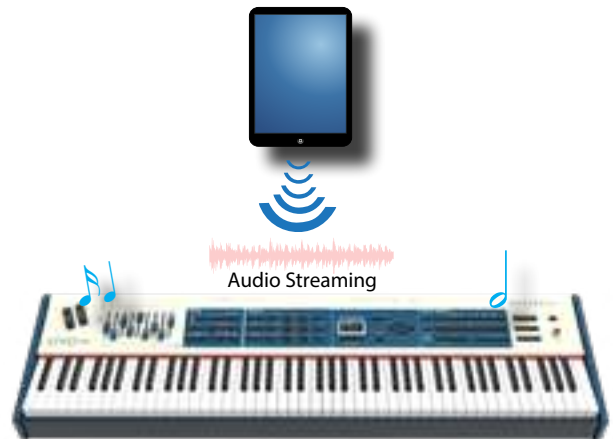

1. If necessary, turn on the Bluetooth® function of the VIVO S10 and pair your mobile device. You don't need it if it's already paired.

See "Turning on the VIVO S10's Bluetooth® Functions" (p. 62) and "Connecting with the Mobile Device" (p. 62).

2. Locate your mobile device near the VIVO S10.

3. Turn on the Bluetooth® function of your mobile device.



All music data played back by the your mobile device can be now heard through the VIVO S10.

MEMO

To adjust the USB audio level refer to "USB AUDIO" (p. 74).

Transferring Bluetooth® MIDI Data

Here's how to do for transmitting and receiving MIDI data between the VIVO S10 and your mobile device.



In particular, we will take as an example the connection between the VIVO S10 and the "Dexibel VIVO EDITOR" application.



What is the "Dexibell VIVO EDITOR" application?

It a free iOS application downloadable from **Apple Store**.

What does the "Dexibell VIVO EDITOR" do?

It allows you to modify any parameter of the VIVO S10 in realtime. It is as if the device becomes the color display with touch screen of your instrument.

1. Turn on the "Visible" parameter of the VIVO S10 in the bluetooth page and pair your mobile device.

See "Turning on the VIVO S10's Bluetooth® Functions" (p. 62) and "Connecting with the Mobile Device" (p. 62).

2. Locate your mobile device near the VIVO S10.
3. Turn on the Bluetooth® function of your mobile device.

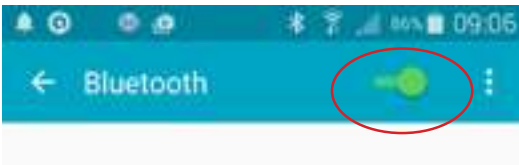

4. Start the "Dexibell VIVO EDITOR" and tap the "MEMORY" page.



5. Tap the "⚙️" icon.



6. In the Bluetooth MIDI field, Tap the "DEVICE" button.



The Bluetooth MIDI devices page is opens and the VIVO S10 (dexi-piano-xx) is in the list of found devices.

7. Tap "Not Connected" to connect the VIVO S10 (dexi-piano-xx).



Wait until the VIVO S10 is connected.

8. Tap "Done" to exit from the page.



Now you can change a tone, activate or deactivate a part, modify the octave, select functions and so on. Now if you want, you can control every function of your instrument by this application without using the VIVO S10's panel anymore.



21 Master Equalizer

VIVO S10 is provided of an useful Master Equalizer. You can adjust Low Gain, Middle Frequencies, Middle Gain and High gain to obtain the best possible sound when listening through an external reproduction system or adapt the sound response of a room.

Real Time Control

You can adjust the master equalizer parameters by the draw-faders. To do this:

1. Press at the same time the [MIXER] and the [MIDI CTRL] buttons.

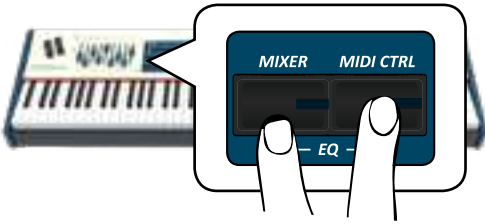

Now the last four draw-faders are assigned to the parameters of equalizer.

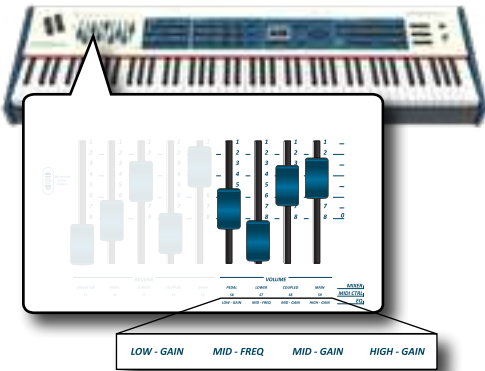

2. Move one of the draw-faders to adjust the desired parameter.

The following temporary window is shown:



3. Use the other draw-faders to choose the best equalization.

For more information regarding the Master Equalizer parameters, see "MASTER EQ" (p. 69).

4. Press at the same time the [MIXER] and the [MIDI CTRL] buttons again to leave this ambient.

Master Equalizer Adjusting

The equalizer give you the possibility to boosting or reducing the low-frequency or high-frequency range of the sound. Adjust the Master EQ parameters to reach the best possible sound when listening through different reproduction systems, headphones, or an external speaker system.

1. Access the "MASTER EQ" page by the [MENU] button →EFFECTS→MASTER EQ.

The list of parameter is shown.



1. Use the [▲], [▼] buttons to select the parameter and use the [DATA ENTRY] knob or the [◀] [▶] buttons to adjust the value.

Parameter	Setting	Explanation
High Gain	-12~ 0 +12 dB	Use this parameter to set the level of the high frequency. Positive values boost (increase) the volume of that frequency. Negative values cut (attenuate) it.
High Freq	400 ~ 10000 Hz	This parameter allows you to set the cutoff frequency of the high band.
Mid Freq	100 ~ 8000 Hz	This parameter allows you to set the cutoff frequency of the middle band.
Mid Gain	-12~ 0 +12 dB	Use this parameter to set the level of the selected MID frequency. Positive values boost (increase the volume of) that frequency. Negative values cut (attenuate) it.
Mid Q	0.5 ~ 12.0	Move this parameter to adjust the width of the area around the Middle frequency that will be affected by the Gain setting. Higher values of Mid Q set narrowest area
Low Gain	-12~ 0 +12 dB	Use this parameter to set the level of the low frequency. Positive values boost (increase) the volume of that frequency. Negative values cut (attenuate) it.
Low Freq	40 ~ 600 Hz	This parameter allows you to set the cutoff frequency of the low band.

Master Equalizer Preset

VIVO S10 comes with some Presets that can be handy in particular situations or a good way to get you started. You might want to start with a preset, then customize it until it is just right and save it in the user area.

1. From the "MASTER EQ" page press the "PRESET" Function button.



2. Use the [DATA ENTRY] knob or the [▲], [▼] buttons to select the desired preset.

3. Press the "SELECT" Function button to confirm your choice.

Its "EQ" icon is highlighted to indicate that the preset has been loaded.

Saving Your User Preset

Make the necessary adjustments to obtain the sound that suits you best.

1. From the "MASTER EQ" page, press the "SAVE" Function button.



2. If you wish, you can give a name to the preset pressing the "RENAME" Function button. For details how to rename see "Assigning the Name You Specify" (p. 23).

3. Press the "WRITE" Function button to save your preset.

The display shows a confirmation message.

MEMO

The current equalizer preset is automatically saved when the VIVO S10 is turned off and reloaded when the power is turned on.

The VIVO S10's [MENU] button provides access to the available parameters and functions.

General procedure

1. Press the [MENU] button.

The display changes to:



2. Use the [DATA ENTRY] knob or the [▲] [▼] buttons to select the entry of the desired function group.

3. Press the [▶] button to go to the display page where you can edit the parameters of the selected group, or to execute the selected command.

For more details about the parameters selection, see "Moving the Cursor and Setting Parameter Values" (p. 23).

The following parameters and functions are available:

Parameters Group

SETTING Parameters Group	68
MAIN SETTING	68
Level	68
Panpot	68
Octave	68
Mute	68
Coarse Tune	68
Fine Tune	68
Note Low	68
Note High	68
COUPLED SETTING	68
Level	68
Panpot	68
Octave	68
Mute	68
Coarse Tune	68
Fine Tune	68
Note Low	68
Note High	68
LOWER SETTING	69
PEDAL SETTING	69
KEYBOARD TOUCH	69
OCTAVE	69
Main	69
Coupled	69
Lower	69
Pedal	69
ZONE 1	69
ZONE 2	69
ZONE 3	69
ZONE 4	69
TRANSCOPE	69
SPLIT MODE	69
Split Point	69
Split	69
T2L EDITOR	69
EFFECTS	69
MAIN FX	69
COUPLED FX	69
LOWER FX	69
PEDAL FX	69
REVERB	69
MASTER EQ	69
OUTPUT	69
MIDI ZONE (A, B, C, D)	69
CONTROL	70
DAMPER PEDAL	70
Main	70
Coupled	70

Lower	70
Pedal	70
ASSIGN 1 PEDAL	70
Funct.	70
Organ	70
Main	70
Coupled	70
Lower	70
Pedal	70
ASSIGN 2 PEDAL	70
ASSIGN 3 PEDAL	70
EXPRESSION PEDAL	71
Funct.	71
Organ	71
Main	71
Coupled	71
Lower	71
Pedal	71
MORPHING PEDAL	71
Funct.	71
Main	71
Coupled	71
Lower	71
Pedal	71
ASSIGN 1, 2 SWITCH	71
Funct.	71
WHEEL 1	71
Funct.	71
Pitch	71
Main	71
Coupled	71
Lower	71
Pedal	71
WHEEL 2	71
Funct.	72
Organ	72
Main	72
Coupled	72
Lower	72
Pedal	72
AFTERTOUCH	72
Funct.	72
Organ	72
Main	72
Coupled	72
Lower	72
Pedal	72
CONTROL 1/2/3/4/5/6	72
Channel	72
Function	72
SLIDER 1, 2, 3, 4, 5, 6, 7, 8, 9	72
Channel	72
Function	72
TUNING	72
MASTER TUNE	72
TEMPERAMENT	73
Equal Flat	73
Equal Stretch (default)	73
VIVO Stretch	73
Vallotti	73
Just Major	73
Pythagorean	73
Mean-Tone	73
Werckmeister III	73
Kimberger III	73
User 1, User 2, User 3	73
MEMORY	74
USB MEMORY	74
SONG EXPLORER	74
REMOVE	74
FORMAT	74
USB AUDIO	74
Input Level	74
Output Level	74
AUDIO INPUT	74
LEVEL	74
BLUETOOTH	74
MIDI	75
RECEPTION	75
Main, Coupled, Lower, Pedal	75
Status	75
Channel	75
Shift	75
Modulation	75
Volume	75
Panpot	75

Expression75
 Aftertouch75
 Reverb75
 Hold75
 Sostenuato75
 Soft75
 PG (Program Change)75
 PB (Pitch Bender)75
 Memory RX76
 Status76
 Channel76
 Organ Control RX76
 Status76
 Channel76
 TRANSMISSION76
 Main, Coupled, Lower, Pedal76
 Status76
 Channel76
 Shift76
 Local76
 Modulation76
 Volume76
 Panpot76
 Expression76
 Aftertouch76
 Reverb76
 Hold76
 Sostenuato76
 Soft76
 PG (Program Change)76
 PB (Pitch Bender)76
 Memory TX76
 Status76
 Channel76
 Organ Control TX76
 Status76
 Channel76
 Common TX77
 Active Sensing (FEH)77
 MIDI SET77
 SAVE MIDI SET77
 EXPORT MIDI SET77
 IMPORT MIDI SET77
 GLOBAL77
 Auto OFF77
 Switch77
 Pedal77
 Wheel77
 Motor Slider77
 SOUND LIBRARY78
 SOUND SETUP78
 SOUND LIST78
 FACTORY RESET78
 FACTORY SOUND78
 BACKUP78
 PANIC78
 VERSION INFO78

PARAMETERS MEMORY AREA

The parameters of the instrument are stored in two memory areas. Each icon will show you on which area the parameters will be stored.

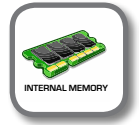

SETTING Parameters Group

[MENU] button →SETTING

In this parameters group you can access to the important settings of your instrument.



▶ MAIN SETTING

This is where you can edit parameters related to keyboard Main part.

Parameter	Setting	Explanation
Level	0 ~ 127	Adjusts the volume of the Main keyboard part. Selecting "0" means that the part is question is no longer audible.
Panpot	-64 ~ 0 ~ +63	Use this parameter to set the stereo placement of the selected instrument. "0" means "no change", negative values shift the instrument towards the left, and positive values shift it towards the right.
Octave	-4 ~ 0 ~ +4	Use this parameter to transpose the Main part up or down by up to 4 octaves.
Mute	OFF, ON	Select "ON" to mute the keyboard part.
Coarse Tune	-24 ~ 0 ~ +24	The Coarse and Fine Tune are used to create interference pattern between two sounds of slightly different frequencies. Changes the pitch in semi-tone steps.
Fine Tune	-99 ~ 0 ~ +99	Changes the pitch in steps of 1 cent (1/100 semi-tone).
Note Low	A0 ~ B7	You can set the keyboard range for the Main part.
Note High	Bb0 ~ C8	

▶ COUPLED SETTING

Contains the parameters for the Coupled part.

Parameter	Setting	Explanation
Level	0 ~ 127	Same settings as Main part. See above.
Panpot	-64 ~ 0 ~ +63	
Octave	-4 ~ 0 ~ +4	
Mute	OFF, ON	Select "ON" to mute the keyboard part.
Coarse Tune	-24 ~ 0 ~ +24	The Coarse and Fine Tune are used to create interference pattern between two sounds of slightly different frequencies. Changes the pitch in semi-tone steps.
Fine Tune	-99 ~ 0 ~ +99	Changes the pitch in steps of 1 cent (1/100 semi-tone).
Note Low	A0 ~ B7	You can set the keyboard range for the Coupled part.
Note High	Bb0 ~ C8	

▶ LOWER SETTING

Contains the parameters for the keyboard Lower part.
Same settings as Main and Coupled parts. See above.

▶ PEDAL SETTING

Contains the parameters for the keyboard Pedal part
Same settings as Main, Coupled and Lower parts. See above.

▶ KEYBOARD TOUCH

See "Adjusting the Keyboard Response (Key Touch)" (p. 36) and
"Customize the Global Keyboard Response (Key Touch)" (p. 36).

▶ OCTAVE

Parameter	Setting	Explanation
Main	-4 ~ 0 ~ +4	Use this parameter to transpose the selected keyboard part up or down by up to 4 octaves.
Coupled	-4 ~ 0 ~ +4	
Lower	-4 ~ 0 ~ +4	
Pedal	-4 ~ 0 ~ +4	
ZONE 1	4 ~ 0 ~ +4	Use this parameter to transpose the selected Zone up or down by up to 4 octaves. See "Master Keyboard Zone" (p. 59).
ZONE 2	4 ~ 0 ~ +4	
ZONE 3	4 ~ 0 ~ +4	
ZONE 4	4 ~ 0 ~ +4	

▶ TRANSPOSE

This function allows you to transpose the VIVO S10's pitch in semi-tone steps. For more details see "Transposing the pitch of the keyboard" (p. 35).

▶ SPLIT MODE

These parameters allows you to manage the splitting mode of the keyboard.



Parameter	Setting	Explanation
Split Point	F1 ~ E7 Default: C4	See "How to change the Split Point" (p. 27).
Split	OFF, ON Default: ON	See "Play All Parts in Layer Mode" (p. 26).

T2L EDITOR

[MENU] button → T2L EDITOR

See "Personalizing Your Sounds (T2L)" (p. 45).

EFFECTS

[MENU] button → EFFECTS

Your instrument contains two multi-effects (FX-A and FX-B) processor that can be used for processing any Keyboard part you like.

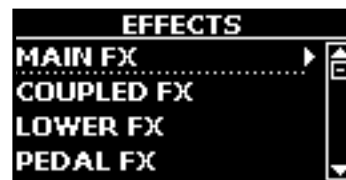

▶ MAIN FX

This selection provides access to the display pages where you can set the effects parameters of the VIVO S10's Main part.



For details regarding effects parameters, refer to the "Effects Types and Parameters" table p. 79.

For more details about the selection of FXs and the relative parameters, see "Adding Effects to Orchestral Sound" (p. 33).

▶ COUPLED FX

Contains the effect parameters for the Coupled part.
Same settings as Main part. See above.

▶ LOWER FX

Contains the effect parameters for the keyboard Lower part.
Same settings as Main part. See above.

▶ PEDAL FX

Contains the effect parameters for the keyboard Pedal part.
Same settings as Main part. See above.

▶ REVERB

See "Adding Reverb to the Sound" (p. 34).

▶ MASTER EQ

Please see "Master Equalizer Adjusting" (p. 65).

OUTPUT

[MENU] button → OUTPUT

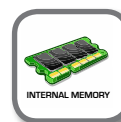

VIVO S10 provides MAIN/SUB unbalanced output (TS jacks) in addition to MAIN balanced output (XLR jacks) as output destinations for the signal of the audio parts

As appropriate for your situation, you can choose which audio output to use (MAIN or SUB) for a certain part (Organ, Main, Coupled, Lower and Pedal).



See "Specifying the Audio Output for Each Part" (p. 37).

MIDI ZONE (A, B, C, D)

[MENU] button → ZONE

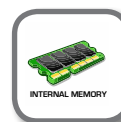

VIVO S10 has four programmable separated MIDI zones. For each zone you can select the MIDI channel, the keyboard range, adjust the Octave, Transpose and many other parameters. See "Master Keyboard Zone" (p. 59).



CONTROL

[MENU] button → CONTROL



This group of parameter is related to the assign switches, pedals, sliders, knobs and wheel controls. The VIVO S10 allows you to manage and assign various functions to these control units.

Here the page where you can assign these functions.



► DAMPER PEDAL



Parameter	Setting	Explanation
Main	Off, On	Off: Select "OFF" if you don't need damper pedal.
Coupled		
Lower		On: Select "On" if you need damper pedal to the keyboard part.
Pedal		

► ASSIGN 1 PEDAL

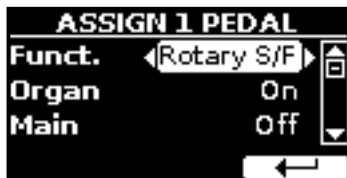

Parameter	Setting	Explanation
Funct.	OFF, Sostenuto, Soft, Damper, FXA On-Off, FXB On-Off, Mem. Prev, Mem. Next, Rotary On/Off, Rotary S/F, Rotary Brake, Perc. On/Off, VibChoOn/Off, Drive On/Off, Morph On/Off, Part On/Off, XMure FillUp, XMure FillDw, XMure SceneUp, XMure SceneDw, XMure Play, XMure Ending, TW Norm/Soft, FXC On-Off Default: Rotary S/F	OFF: No function assigned. See "Pedal Functions Explanation" (p. 70). MEMO Some functions are commands that do not need to specify the part (Main, Coupled, Lower or Pedal).
Organ	Off, On default: On	Off: Select "OFF" if you don't need of pedal. On: the pedal is assigned to the specified part.
Main		
Coupled		
Pedal		

► ASSIGN 2 PEDAL

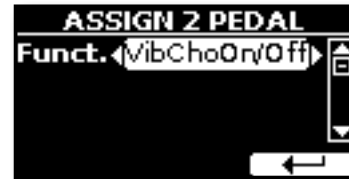

Please refer to the parameter of the ASSIGN 1 PEDAL.

► ASSIGN 3 PEDAL



Please refer to the parameter of the ASSIGN 1 PEDAL.

Pedal Functions Explanation

Function	Explanation
Off	No function assigned.
Sostenuto	The pedal is used as Sostenuto.
Soft	The pedal is used as Soft. The soft pedal reduces the volume and slightly changes the timbre of notes played while the pedal is pressed.
Damper	The pedal is used as a damper.
FXA On-Off FXB On-Off	Allows you to switch the MFXA/B on and off.
Mem. Prev Mem. Next,	Allows you to select the next or previous Memory.
Rotary On/Off	Turns the rotary on or off.
Rotary S/F	This function alternate between the fast and slow Rotary speeds. It does the same function as the [FAST/SLOW] button in the ROTARY panel section
Rotary Brake	This function gradually stops the rotary. It does the same function as the [BRAKE] button in the ROTARY panel section.
Perc On/Off	Add or not the percussion. It does the same function as the [ON] button in the PERCUSSION panel section.

Function	Explanation
VibChoOn/Off	Enable or disable the vibrato or chorus effect. It does the same function as the [ON] button in the VIBRATO/CHORUS panel section.
Drive On/Off	This is the typical effect of vacuum tube amplifier. Add or not the overdrive effect It does the same function as the [OVERDRIVE] button in the ORGAN panel section.
Morph On/Off	Enable or disable the morphing function. It does the same function as the [MORPHING] button in the "ORGAN" section.
Part On/Off	Enable or disable the selected keyboard part.
XMure FillUp XMure FillDw	Using these functions you can select a the next or the previous drum pattern in the XMure® application.
XMure SceneUp XMure SceneDw	These functions allow you to change scene of the accompaniment in the XMure® application.
XMure Play	Play or Stop the playback of a XMure® pattern.
Xmure Ending	Select the Ending pattern.
TW Norm/Soft	This parameter reduce the volume of the tonewheel. See "VOLUME" in the "TW Organ Sound Parameters" (p. 47).
FXC On-Off	Allows you to switch the MFX C on and off.

► EXPRESSION PEDAL



Parameter	Setting	Explanation
Funct.	Expression, Modulation, FX Manual, Sostenuto, Soft	Expression: The pedal is assigned to the expression. Modulation: The pedal is assigned to the Modulation. FX Manual : You can control the "Manual" parameter of the effector. See the "16: Wah-Wah" (p. 81) and the "17: Cut Filter" (p. 81). Sostenuto: The pedal is assigned to the sostenuto. Soft: The pedal is assigned to the Soft.
Organ	Off, On default: On	Off: Select "OFF" if you don't need expression pedal. On: the pedal is assigned to the specified part.
Main		
Coupled		
Lower		
Pedal		

► MORPHING PEDAL



Parameter	Setting	Explanation
Funct.	Morphing, Modulation, FX Manual, Sostenuto, Soft	Morphing: The pedal is assigned to the morphing function. See "Morphing" (p. 30). Modulation: The pedal is assigned to the Modulation. FX Manual : You can control the "Manual" parameter of the effector. See the "16: Wah-Wah" (p. 81) and the "17: Cut Filter" (p. 81). Sostenuto: The pedal is assigned to the sostenuto. Soft: The pedal is assigned to the Soft.
Main	Off, On	Off: Select "OFF" if you don't need of the function for the specified part. On: the pedal is assigned to the specified part.
Coupled		
Lower		
Pedal		

► ASSIGN 1, 2 SWITCH

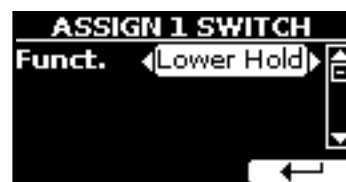

Parameter	Setting	Explanation
Funct.	Mem. Prev Mem. Next	Allows you to select the next or previous Memory.
	Main Hold Lower Hold Coupled Hold	This settings allows you to set the Hold function for the Main, Lower and Coupled part by the Assign Switches.
	XMure FillUp XMure FillDw	Using these functions you can select a the next or the previous drum pattern in the XMure® application.
	XMure SceneUp XMure SceneDw	These functions allow you to change scene of the accompaniment in the XMure® application.
	XMure Play	Play or Stop the playback of a XMure® pattern.
	XMure Ending	Select the Ending pattern.

► WHEEL 1



Parameter	Setting	Explanation
Funct	Pitch	Change the pitch of the notes you are playing.
Pitch	0 ~ +24	Select the pitch interval.
Main	Off, On default: On	Off: the pitch change does not affect the part. On: the pitch change acts on the part.
Coupled		
Lower		
Pedal		

► WHEEL 2



Parameter	Setting	Explanation
Funct.	Modulation, Expression, FX Manual Default: Modulation	Modulation: Using the WHEEL 2 you will add modulation to the notes you are playing at that time. Expression: The WHEEL 2 is assigned to the expression. FX -Manual: You can control the "Manual" parameter of the effector. See the "16: Wah-Wah" (p. 81) and the "17: Cut Filter" (p. 81).
Organ	Off, On	Off: the Whell 2 assigned function does not affect the part. On: the Whell 2 assigned function acts on the part.
Main		
Coupled		
Lower		
Pedal		

Parameter	Setting	Explanation
Channel	1 ~ 16, Zone	1 ~ 16: Select the MIDI channel. Zone: The channel is linked to the Zone MIDI channel. Use this setting when use the zone function. See "Master Keyboard Zone" (p. 59)..
Function	CC1 ~ CC127 NOTE You can't assign CC#32 (Bank select LSB).	CC#: You can choose one of 127 control change. You send control change values moving the Knob C1, C2, C3, C4, C5 or C6.

► SLIDER 1, 2, 3, 4, 5, 6, 7, 8, 9

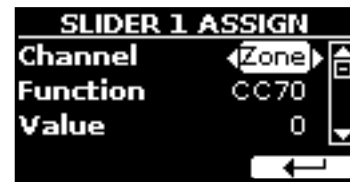

This pages allows you to assign a function to the nine sliders (drawbars).

Parameter	Setting	Explanation
Channel	1 ~ 16, Zone	1 ~ 16: Select the MIDI channel. Zone: The channel is linked to the Zone MIDI channel. Use this setting when use the zone function. See "Master Keyboard Zone" (p. 59).
Function	CC1 ~ CC127 NOTE You can't assign CC#32 (Bank select LSB).	CC#: You can choose one of 127 control change. You send control change values moving the sliders.

► AFTERTOUCH



Parameter	Setting	Explanation
Funct.	Aftersmooth, Modulation, FX Manual, Rotary S/F Default: Aftersmooth	Aftersmooth: You can control the aftersmooth. Modulation: You can control the modulation by the aftersmooth. FX -Manual: You can control the FX manual of the effector by the aftersmooth, see "16: Wah-Wah" (p. 81) and "17: Cut Filter" (p. 81). Rotary S/F: The aftersmooth controls: <ul style="list-style-type: none"> the TW Rotary slow/fast if an organ sound (tonewheel) is selected. the FX Rotary Speed of the effector if an orchestral sound is selected. See "12: Rotary" (p. 80).
Organ	Off, On	Off: the aftersmooth assigned function does not affect the part. On: the aftersmooth assigned function acts on the part.
Main		
Coupled		
Lower		
Pedal		

For details, see "Aftersmooth" (p. 35).

► CONTROL 1/2/3/4/5/6

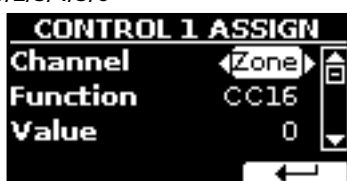

This pages allows you to assign a function to the knobs (C1, C2, C3, C4, C5, C6).

TUNING

[MENU] button → TUNING



► MASTER TUNE



Setting	Explanation
415.30 Hz~ 440.00 Hz~ 466.10 Hz	Select the desiderate tuning.
"440.00 Hz" Function button	Use the "440.00 Hz" and "442.00 Hz" Function buttons to tuning the instrument at those values.
"442.00 Hz" Function button	

Some Information About the Master Tune

The instruments are generally tuned to an A 440 pitch standard that was adopted during the early 1900s in response to widely varying standards. Previously the pitch standards had gradually risen from about A 415 during the late 1700s and early 1800s to A 435 during the late 1800s. Though A 440 is generally the standard, some orchestras, particularly in Europe, use a higher pitch standard, such as A 444.

► **TEMPERAMENT**



NOTE

This function doesn't work when a TW1, TW2, FARF or VX type organ is selected.

The modern instruments are tuning in Equal Stretch temperament, in which every pair of adjacent pitches is separated by the same interval.

There are other scale used in different music style. Modern musical scale in western culture are different in one other way from older classic music. At the time of Bach the scales were based on the note A being about 415 Hz. In the Handel's time the frequency A was 422.5 Hz and today it is 440.0 Hz.

Setting	Explanation
Equal Flat	This tuning divides each octave into 12 equal steps (intervals).
Equal Stretch (default)	Equal Stretch: This tuning is a correction of Equal Flat. A benefit of stretching octaves is the correction of dissonance that equal temperament imparts to the perfect fifth.
VIVO Stretch	This tuning is similar to the Equal Stretch with small adjustments to make it more suitable for piano sounds.
Vallotti	This tuning is the default for many of today's Baroque musicians.
Just Major	This is a just scale for pieces in mayor keys.
Pythagorean	This system was invented in ancient Greece. It resolves the ambiguity of fourths and fifths. Though thirds are somewhat imperfect, melodies sound clearer.
Mean-Tone	A temperament that adds some compromises to the just temperament and facilitates transposition.
Werckmeister III	A combination of the Mean Tone and Pythagorean temperaments, this tuning allows for playing in any key.
Kimberger III	As a result of improvements made to the Mean Tone and Just temperaments, this tuning system is relatively tolerant towards transposition and can be used to play in all keys.
User 1, User 2, User 3	User 1, User 2, User 3: These settings refer to the tuning systems programmed by yourself (or someone else).

1. Select your favorite temperament scale .
2. Press the "RECALL" Function button to load the scale.

The temperament scale is recalled.

Editing the Equal Flat, Equal Stretch or Vivo Stretch scale

If you selected the Equal Flat, Equal Stretch or Vivo Stretch scale:

The "EDIT" Function button appears.

1. Press the "EDIT" Function button to program your scale.



In the example above we select the Equal Stretch scale.

2. To select a note, use the [▲][▼] or play a note on the keyboard.
3. Use the [◀][▶] buttons or the [DATA ENTRY] knob to modify the tuning of the selected note.
4. Press [HERTZ/CENT] Function button to change the tuning in steps of 1/100 of cent.

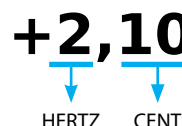

Setting	Explanation
-99.99 ~ 0 ~ +99.99 (cent)	Set the note tuning.

5. Press the "WRITE" Function button to save your scale.

The following page appears:



6. Use the [DATA ENTRY] knob or the [▲][▼] buttons to select the USER scale where you want save your scale.

7. Press the "WRITE" Function button to save your scale.

A message of confirmation appears.

If you selected a scale other than equal temperament:

1. If you selected a scale other than equal temperament as Pythagorean, Mean-Tone, Werckmeister III, Kimberger III and the Just Major and Minor temperament scale, you can specify the root note:

The "ROOT NOTE" Function button appears.



2. Press the "ROOT NOTE" Function button if you want specify the base note.



3. Select the root note.

Setting	Explanation
C, C#, D, Eb, E, F, F#, G, Ab, A, Bb, B	Select the base note of the temperament scale.

4. Press the "←" Function button come back to previous page.

If you selected one of USER scales:

The "EDIT" Function button appears.



1. Press the "EDIT" Function button to program your scale.



2. To select a note, use the [▲][▼] or play a note on the keyboard.

3. Use the [◀][▶] buttons or the [DATA ENTRY] knob to modify the tuning of the selected note.

4. Press [HERTZ/CENT] Function button to change the tuning in steps of 1/100 of cent.

Setting	Explanation
-99.99 ~ 0 ~ +99.99 (cent)	Set the note tuning.

5. Press the "WRITE" Function button to save your scale.

A message of confirmation appears.

6. Press the "←" Function button come back to previous page.



► SONG EXPLORER

VIVO S10 has useful files navigation function (Song Explorer) that allow you to rename or remove a previously-saved song on a USB Memory. See "How to Rename or Remove Songs on a USB Memory (Song Explorer)" (p. 56).

► REMOVE

Before to unplug the USB Memory, use this function to safely remove it. See "Safely Remove the USB Memory" (p. 20).

► FORMAT

Use this function to format your USB Memory. See "How to Format the USB Memory" (p. 20).

USB AUDIO

[MENU] button → USB AUDIO

Use this function if you need to adjust the audio output and input levels via USB.



Parameter	Setting
Input Level	-inf ~ 0 dB Default: 0 dB
Output Level	-inf ~ 0 dB Default: 0 dB

MEMORY

[MENU] button → MEMORY

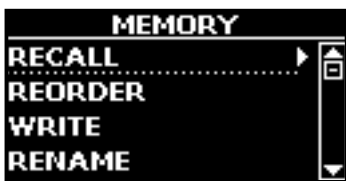
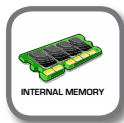

For the explanation of this section please refer to "Working with the Memories" (p. 50).

AUDIO INPUT

[MENU] button → AUDIO INPUT

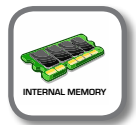

► LEVEL

Setting	Explanation
0~ 127	Here you can adjust the input level of the signals received via Audio In socket.

USB MEMORY

[MENU] button → USB MEMORY

BLUETOOTH

[MENU] button → BLUETOOTH

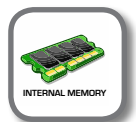

VIVO S10 is equipped with Bluetooth® Audio function.

Thanks to this technology, you'll be able to stream music wirelessly from a Bluetooth® capable smartphone, tablet or computer to VIVO S10.

See "Wireless Function" (p. 62).

MIDI

[MENU] button →MIDI

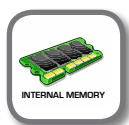

This group allow you to configure the MIDI parameters. You can transfer MIDI data between the VIVO S10 and your sequencer software or other MIDI device.



Here is a brief explanation of VIVO S10 keyboard parts:

Part	Explanation
Main	<p>If an orchestral or organ (tonewheel) sound is selected, the note played in the keyboard are sent to the MIDI Main part.</p> <p style="text-align: center;">Main Part</p>
Coupled	<p>This part can be combined with the Main part. To do this press the [COUPLED] button. The second part (COUPLED Part) play over the entire keyboard in combination with the Main part.</p> <p style="text-align: center;">Main Part + Coupled Part</p>
Lower	<p>This part is activated pressing the [LOWER] button. The keyboard is automatically split into two halves: Left and Right. The region of the keyboard to the left of the split point becomes the Lower part , while the region of the keyboard to the right of the split point becomes the Main part.</p> <p style="text-align: center;">Lower Part Main Part</p>
Pedal	<p>This part is activated pressing the [PEDAL] button. The keyboard is automatically split into two halves. The region of the keyboard to the left of the split point becomes the Pedal part , while the region of the keyboard to the right of the split point becomes the Main part.</p> <p style="text-align: center;">Pedal Part Main Part</p> <p>If the Lower part is active, the pedal part is monophonic and the leftmost note played on the keyboard is added. In all other cases the Lower part si polyphonic.</p>
Memory	<p>This part is used to receive or send MIDI messages for the selection of the memories by an external instrument.</p>
Organ control	<p>This part is used to control the position of the draw-faders via MIDI.</p>

1. Select the group of parameters you need (Reception, Transmission, MIDI Set and Save MIDI Set)

► RECEPTION



You can configure the MIDI receive parameters of Main, Coupled, Lower and Pedal part. Additionally, you can manage the received MIDI messages for the memories and Organ control.

1. Select the part you want to edit (Main, Coupled, Lower and Pedal).



In the example above we selected the Main part.

Main, Coupled, Lower, Pedal		
Parameter	Setting	Explanation
Status	OFF, ON Default: On	Select "On" if you want the selected part to receive MIDI data.
Channel	1 ~ 16	Allows you to assign a MIDI receive channel to the selected part.
Shift	-48~-0~+48 Default : 0	This parameter allows you to transpose the received note messages before sending them to the VIVO S10's tone generator. The maximum possible transposition is four octaves up (48) and down (-48). Each step represents a semi-tone.
Modulation	OFF, ON Default: On	These filters allow you to specify whether (On) or note (Off) the messages in question should be received.
Volume		
Panpot		
Expression		
Aftertouch		
Reverb		
Hold		
Sostenuto		
Soft		
PG (Program Change)		
PB (Pitch Bender)		

Part	MIDI RX channel (default)
Main	1
Coupled	2
Lower	3
Pedal	4
Memory	15
Organ control	14

2. If you selected the "Memory" part, the following page is showed:

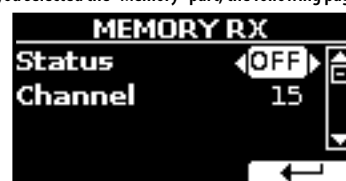

Memory RX		
Parameter	Setting	Explanation
Status	OFF, ON Default: On	Select "On" if you want to receive MIDI messages for the memories selection.
Channel	1 ~ 16 default: 15	Allows you to assign a MIDI receive channel to the "Memory" part.

3. If you selected the "Organ Control" part, the following page is showed:



Organ Control RX		
Parameter	Setting	Explanation
Status	OFF, ON Default: On	Select "On" if you want to receive draw-faders MIDI messages. For details regarding the MIDI messages received, see "Draw-faders MIDI Controls" (p. 84).
Channel	1 ~ 16 default: 14	Allows you to assign a MIDI receive channel to the "Organ control" part.

Main, Coupled, Lower, Pedal		
Parameter	Setting	Explanation
Modulation	OFF, ON Default: On	These filters allow you to specify whether (On) or note (Off) the messages in question should be transmitted.
Volume		
Panpot		
Expression		
Aftertouch		
Reverb		
Hold		
Sostenuto		
Soft		
PG (Program Change)		
PB (Pitch Bender)		

2. If you selected the "Memory" part, the following page is showed:



Memory TX		
Parameter	Setting	Explanation
Status	OFF, ON Default: On	Select "On" if you want to transmit MIDI messages when you recall a memory. See "Working with the Memories" (p. 50).
Channel	1 ~ 16 default: 15	Allows you to assign a MIDI transmit channel to the "Memory" part.

▶ TRANSMISSION



You can configure the MIDI transmission parameters of Main, Coupled, Lower and Pedal part. Additionally, you can manage the transmitted MIDI messages for the memories and Organ control. By the "COMMON" section, you can decide whether to send or not the "Active Sensing" MIDI messages.

1. Select the part you want to edit (Main, Coupled, Lower and Pedal).



In the example above we selected the Main part.

Main, Coupled, Lower, Pedal		
Parameter	Setting	Explanation
Status	OFF, ON Default: On	Select "On" if you want the selected part to transmit MIDI data.
Channel	1 ~ 16 Default: 1	Allows you to assign a MIDI transmit channel to the selected part.
Shift	-48~0~+48 Default : 0	This parameter allows you to transpose the note messages before they are transmitted to an external MIDI device. The maximum possible transposition is four octaves up (48) or down (-48).
Local	OFF, ON Default: On	You can disconnect the part from the internal sound source ("Off") – or re-establish that connection ("On").

3. If you selected the "Organ Control" part, the following page is showed:



Organ Control TX		
Parameter	Setting	Explanation
Status	OFF, ON Default: On	Select "On" if you want transmit position MIDI messages of the draw-faders. For details regarding the MIDI messages transmitted, see "Draw-faders MIDI Controls" (p. 84).
Channel	1 ~ 16 default: 14	Allows you to assign a MIDI transmit channel to the "Organ control" part.

4. If you selected the "Common" part, the following page is showed:



Common TX		
Parameter	Setting	Explanation
Active Sensing (FEH)	OFF, ON Default: On	This MIDI message is transmitted constantly at intervals of approximately 250 ms. This MIDI message is used to monitor the MIDI connection. If there was a disconnection, after a connection has been made, the connected device no longer receives the active sensing (FEH) message and reset all notes that have remained actives. Select "On" if you want to transmit the Active Sensing MIDI.

► MIDI SET

MIDI Sets are memories for MIDI settings. The VIVO S10 provides five MIDI Set memories.

The first MIDI Set, called "Dexibell", is read-only and allows you to restore the MIDI factory setting.

The second MIDI Set called "KeyboardZone", it is read-only and is a fast way to configure the MIDI channels using the zones. See "Master Keyboard Zone" (p. 59).

The third MIDI Set called "Pedalboard", it is read-only. It's a quick way to configure the MIDI channels using an external Pedalboard. The keyboard pedal part is set Local Off. In other words, the internal connection between the keyboard part and the tone generator is interrupted.

The other three memories (User 1, User 2, User 3) allow use to memorize and recall your MIDI configuration.



1. Use the [DATA ENTRY] knob or the [▲][▼] to select the MIDI Set and press the "RECALL" Function button to load it.
2. Press the "SAVE" Function button to jump in the SAVE MIDI SET page.

► SAVE MIDI SET



1. Use the [DATA ENTRY] knob or the [▲][▼] to select the MIDI Set memory and press the "WRITE" Function button to save your configuration.

► EXPORT MIDI SET

You can save your MIDI SET in a USB Memory.



1. Connect the USB Memory to which you wish to save the data. See "Connecting an USB Memory (commercially available)" (p. 19).
2. Use the "OPEN" function button to select the folder where you want save the data.

3. Press the "EXPORT" function button to perform the export operation.

► IMPORT MIDI SET

You can load your MIDI SET previous saved in a USB Memory.



1. Connect a USB Memory containing the previously saved MIDI SET data. See "Connecting an USB Memory (commercially available)" (p. 19).
2. Use the "OPEN" function button to select the folder that contains the data.
3. Press the "IMPORT" function button to perform the operation.

GLOBAL



[MENU] button → GLOBAL

This parameter is automatically saved in the VIVO S10 global memory area.



Parameter	Setting	Explanation
Auto OFF	Off, 5 min, 10 min, 30 min, 2 hours, 4 hours Default: 2 hours	This parameter allows you to cause the VIVO S10 to switch itself off after the selected number of minutes has elapsed if you are not using it. Select "Off" if you prefer not to use this function.
Switch	Global, Memory Default: Memory	Global: Set this value if you want the switch assignments are saved in the global area. The switch assignment does not depend on the recalled memory. Memory: Set this value if you want the switch assignments are saved in the Memories. The switch assignment depends on the recalled memory. For the switch assignments, see "ASSIGN 1, 2 SWITCH" (p. 71).
Pedal	Global, Memory Default: Memory	Global: Set this value if you want the pedal assignments are saved in the global area. The pedal assignment does not depend on the recalled memory. Memory: Set this value if you want the pedal assignments are saved in the Memories. The pedal assignment depends on the recalled memory. For the pedal assignments, see p. 70.
Wheel	Global, Memory Default: Memory	Global: Set this value if you want the Wheel 1 and the Wheel 2 assignments are saved in the global area. The Wheel assignment does not depend on the recalled memory. Memory: Set this value if you want the Wheel 1 and the Wheel 2 assignments are saved in the Memories. The Wheel assignment depends on the recalled memory. For the Wheel assignments, see p. 71.
Motor Slider	Off, On Default: On	On: Set this value if you want the draw faders motorised. Off: Set this value if you do not want the draw faders motorised.

SOUND LIBRARY

[MENU] button →SOUND LIBRARY

You can import sounds library in the internal memory of VIVO S10 and use them in your performances. For details see "Additional Sound (Sound Library)" (p. 40).

SOUND SETUP

[MENU] button →SOUND SETUP

This is a useful function that allows you to prepare a sound set for a performance. If, in a performance, you will use only piano sounds, you can create a Sound Set that contain only piano sounds. In this way you can use the maximum size of internal memory of the module for piano sounds.

For details see "Sound Setup (Export/Import)" (p. 44).

At your convenience, you can also download sound sets from the <http://www.dexibell.com/> website.

SOUND LIST

[MENU/EXIT] button →SOUND LIST

This function allows you to reorder the tone list. Please see "How to Reorder the Tone List" (p. 27).

FACTORY RESET

[MENU] button →FACTORY RESET

This function allows you to recall the VIVO S10's original factory settings. Please see "Restoring the Factory Settings (Factory Reset)" (p. 38).

FACTORY SOUND

[MENU] button →FACTORY SOUND

This function allows you to restore all sound libraries as they came out of the factory. Please see "Restore the Factory Sounds" (p. 38).

BACKUP

[MENU/EXIT] button →BACKUP

Use this function to back up contents, settings, and sounds list from your VIVO S10 into a USB Memory. See "How to Protect Your Settings, Contents and Sounds List (Backup)" (p. 38).

PANIC

[MENU/EXIT] button →PANIC

Use this function if some operation on your instrument or an external tone generator (connected via a MIDI cable) has caused strange sounds or stuck some notes. See "Panic Function" (p. 39).

VERSION INFO

[MENU] button →VERSION INFO

This page shows you the version number of the VIVO S10's operating system.

23 Appendix

Effects Types and Parameters List

1: Thru

The effects processor is bypassed.

2: EP Tremolo

This effect cyclically modulates (Speed) the amplitude (Intensity) to add tremolo to the sound. It's the electric piano typical effect.

Parameter	Setting	Explanation
Speed	0.10 ~ 12.50 Hz	Sets the speed of the tremolo effect.
Intensity	0 ~ 100	Depth to which the effect is applied.

3: Equalizer

This is a four-band stereo equalizer (low, mid x 2, high).

Parameter	Setting	Explanation
Low Freq	40 ~ 400 Hz	Selects the frequency of the low range.
Low Gain	-12 ~ 0 ~ +12	Adjusts the gain of the low frequency.
High Freq	400 Hz ~ 8 KHz	Selects the frequency of the high range.
High Gain	-12 ~ 0 ~ +12	Adjusts the gain of the high frequency.
Mid1 Freq	100Hz ~ 4 KHz	Selects the frequency of the Mid1 range.
Mid1 Gain	-12 ~ 0 ~ +12	Adjusts the gain of the Mid1 frequency.
Mid1 Q	0.5 ~ 12.0	Move this parameter to adjust the width of the area around the Middle 1 frequency that will be affected by the Gain setting. Higher values of Mid1 Q set narrowest area.
Mid2 Freq	100Hz ~ 4KHz	Selects the frequency of the Mid2 range.
Mid2 Gain	-12 ~ 0 ~ +12	Adjusts the gain of the Mid2 frequency.
Mid2 Q	0.5 ~ 12.0	Move this parameter to adjust the width of the area around the Middle 2 frequency that will be affected by the Gain setting. Higher values of Mid2 Q set narrowest area.

4: Vibrato

Vibrato is a musical effect consisting of a regular, pulsating change of pitch. It is used to add expression to instrumental music.

Parameter	Setting	Explanation
Rate	0.10 ~ 12.50 Hz	Sets the speed of the vibrato effect.
Intensity	0 ~ 100	Allows you to set the vibrato intensity.

5: Flanger

This effect gives a significant swell and movement of pitch to the sound. It produces a metallic resonance effect.

Parameter	Setting	Explanation
Rate	0.10 ~ 12.50 Hz	Adjust the modulation speed.
Intensity	0 ~ 100	Allows you to set the flanger intensity.

Parameter	Setting	Explanation
Feedback	-96 ~ +96 %	Adjusts the proportion of the flanger sound that is fed back into the effect. Negative (-) settings will invert the phase.
Balance	0 ~ 100	Balance the Volume between the direct and the effect sound.
PreDelay	0 ~ 100 ms	Adjusts the delay from the direct signal and the moment when the flanger starts working.
Phase	0 ~ 180 deg	This sets the LFO phase difference between the left and right, in steps of 10 degrees It give more spatial of the sound.

6: Chorus

This effect adds thickness and warmth to the sound by modulating the delay time of the input signal. You can add spread to the sound by offsetting the phase of the left and right LFOs from each other.

Parameter	Setting	Explanation
Rate	0.10 ~ 12.50 Hz	Adjust the modulation speed.
Intensity	0 ~ 100	Allows you to set the chorus intensity.
Feedback	-96 ~ +96 %	Adjusts the proportion of the chorus sound that is fed back into the effect. Negative (-) settings will invert the phase.
Balance	0 ~ 100	Balance the Volume between the direct and the effect sound.
PreDelay	0 ~ 100 ms	Adjusts the delay from the direct signal and the moment when the chorus starts working.
Phase	0 ~ 180 deg	This sets the LFO phase difference between the left and right, in steps of 10 degrees.

7: Phaser

This effect creates a swell by shifting the phase. It is very effective on electric piano sounds. You can add spread to the sound by offsetting the phase of the left and right LFOs from each other.

Parameter	Setting	Explanation
Rate	0.10 ~ 12.50 Hz	Adjust the modulation speed.
Intensity	0 ~ 100	Allows you to set the phaser intensity.
Feedback	-96 ~ +96 %	Adjusts the proportion of the phaser sound that is fed back into the effect. Negative (-) settings will invert the phase.
Phase	0 ~ 180 deg	This sets the LFO phase difference between the left and right, in steps of 10 degrees.

8: Reverb

This effect adds reverberation to the sound, simulating an acoustic space as a room or a larger halls or stadiums.

Parameter	Setting	Explanation
Level	0 ~ 127	Set the quantity of Reverb effect
Damping	0 ~ 127	Adjusts the amount of damping of the room (Carpet, Wood, Brick, Concrete, Marble). Higher values increase the amount of high-frequency attenuation.

Parameter	Setting	Explanation
Room Size	0 ~ 127	It determines the size of the simulated room.
Width	0 ~ 127	Adjusts the stereo width of the Reverb effect. Higher value increase the stereo width.
PreDelay	0 ~ 100 ms	Adjusts the delay from the direct signal and the moment when the reverb starts working. This is used to simulate the distance between the original signal and the reflective surfaces.

9: Delay

The delay effect is used to simulate echo (repetition).

Parameter	Setting	Explanation
Delay L	0 ~ 750 ms	Sets the delay time for the left channel.
Delay R	0 ~ 750 ms	Sets the delay time for the right channel.
Feedback	-96 ~ +96 %	Adjusts the proportion of the delay sound that is fed back into the effect. Negative (-) settings will invert the phase.
Wet	0 ~ 100 %	Adjust the quantity of the delayed ("wet") signal.
Dry	0 ~ 100 %	Adjust the quantity of the unmodified ("dry") signal.

10: Cross Delay

Cross Delay allows you to create advanced stereo delay.

Each echo can be sent to the opposite channel from the source signal (echo of the left channel is heard on the right).

Parameter	Setting	Explanation
Delay L	0 ~ 750 ms	Sets the delay time for the left channel.
Delay R	0 ~ 750 ms	Sets the delay time for the right channel.
Feedback	-96 ~ +96 %	Adjusts the proportion of the delay sound that is fed back into the effect. Negative (-) settings will invert the phase.
Wet	0 ~ 100 %	Adjust the quantity of the delayed ("wet") signal.
Dry	0 ~ 100 %	Adjust the quantity of the unmodified ("dry") signal.

11: Triple Tap Delay

The Triple Tap Delay produces three delay sounds: center, left and right..

Parameter	Setting	Explanation
Delay L	0 ~ 750 ms	Sets the delay time for the left channel.
Delay R	0 ~ 750 ms	Sets the delay time for the right channel.
Delay C	0 ~ 750 ms	Sets the delay time for the center (L+R) channel.
Feedback	-96 ~ +96 %	Adjusts the proportion of the delay sound that is fed back into the effect. Negative (-) settings will invert the phase.
Level L	0 ~ 100	Adjust the volume of the left delay sound.
Level R	0 ~ 100	Adjust the volume of the right delay sound.
Level C	0 ~ 100	Adjust the volume of the center delay sound.
Wet	0 ~ 100 %	Adjust the quantity of the delayed ("wet") signal.
Dry	0 ~ 100 %	Adjust the quantity of the unmodified ("dry") signal.

12: Rotary

The rotary is a typical effect generated by the rotation of the speakers, this rotation creates a Larsen effect. It gives spaciousness to the sound.

Parameter	Setting	Explanation
Speed	Slow, Fast	Switches the speaker rotation speed between slow and fast.
Brake	OFF, ON	This parameter allows you to manually control the wheel brake. Off is the default; the tone wheels will turn normally. Changing this to On will make the tone wheels gradually slow down and stop.
Vibrato Sw	OFF, ON	Disable and enable the vibrato effect.
Vibrato Type	V1, C1, V2, C2, V3, C3	This selects one of the six classic Vibrato/Chorus presets. "V" stands for Vibrato, and "C" stands for Chorus.

13: Tremolo

This effect cyclically modulates (Speed) the amplitude (Intensity) to add tremolo to the sound.

Parameter	Setting	Explanation
Speed	0.10 ~ 12.50 Hz	Sets the speed of the tremolo effect.
Intensity	0 ~ 100	Depth to which the effect is applied.

14: Tremolo Pan

This effect is similar to the Tremolo. It include an extra parameter that indicate the phase between the left or right channel.

Parameter	Setting	Explanation
Speed	0.10 ~ 12.50 Hz	Sets the speed of the tremolo effect.
Intensity	0 ~ 100	Depth to which the effect is applied.
Phase	0 ~ 180 deg	This sets the LFO phase difference between the left and right, in steps of 10 degrees.

15: Overdrive

This effect is designed to work and sound like an old tube amp turned up loud. It suitable for hard rock and similar musical genres.

Parameter	Setting	Explanation
Drive	1 ~ 100	Higher Drive settings, mean more distortion.
Tone	100 Hz ~ 10.0 KHz	Use this parameter to accent or attenuate certain dominant or unwanted overtones.
Level	0 ~ 100	Increase or decrease the volume of the effect.
Low Freq	80 ~ 400	Selects the frequency of the low range.
Low Gain	-12 ~ 0 ~ +12	Adjusts the gain of the low frequency.
High Freq	800Hz ~ 8KHz	Selects the frequency of the high range.
High Gain	-12 ~ 0 ~ +12	Adjusts the gain of the high frequency.

16: Wah-Wah

It is a type of effect that alters the tone and frequencies of the input signal to create a unique sound, mimicking the human voice and taking the onomatopoeic name "Wah-Wah".

Parameter	Setting	Explanation
Mode	Auto, Manual, Envelope	<p>Auto: The "Manual" parameter is automatically controlled by the internal LFO.</p> <p>Manual: The "Manual" parameter is controlled by the expression pedal or the WHELL 2. Remember that in addition, the Expression Pedal socket must be assigned to the function "FX-MANUAL". See "EXPRESSION PEDAL" (p. 71) and "WHEEL 2" (p. 71). This parameter can be also controlled by the aftertouch.</p> <p>Envelope: the effect is controlled by the envelope of the sound and consequently by the dynamics of the notes played on the keyboard.</p>
Manual	0 ~ 127	<p>Adjusts the center frequency at which the effect is applied.</p> <p>This parameter can be also controlled by the expression pedal or the WHELL 2 (if your instrument is equipped with WHELL 2). Remember that in addition, the Expression Pedal socket must be assigned to the function "FX-MANUAL". See "EXPRESSION PEDAL" (p. 71).</p>
Filter	Low Pass, High Pass, Band Pass, Peak	<p>Low Pass : The wah effect will be applied over a low frequency range.</p> <p>High Pass: The wah effect will be applied over a high frequency range.</p> <p>Band Pass : The wah effect will be applied over a narrow frequency range.</p> <p>Peak: The wah effect will be applied over a specific center frequency.</p>
Low Freq	100Hz ~ 10.0KHz	Selects the frequency of the low range.
High Freq	100Hz ~ 10.0KHz	Selects the frequency of the High range.
Low Q	0.5 ~ 10.0	Move this parameter to adjusts the width of the area around the Low or High Frequency.
Hi Q	0.5 ~ 10.0	
LFO Rate	0.1Hz ~ 12.50Hz	Frequency of modulation.
LFO Curve	Linear, Quadratic	LFO curve trend.
Balance	0 %~ 100%	Adjusts the balance between original and the effect sound.
Env Threshold	-40dB ~ 0dB	Adjust the threshold of the envelop
Env Attack	0ms ~ 250ms	Adjust the attack of the envelop
Env Release	0ms ~ 1000ms	Adjust the release of the envelop

17: Cut Filter

This filter that attenuates ("cut") some frequency range.

Parameter	Setting	Explanation
Manual	0 ~ 127	<p>Adjusts the center frequency at which the effect is applied.</p> <p>This parameter can be also controlled by the expression pedal or the WHELL 2. Remember that in addition, the Expression Pedal socket must be assigned to the function "FX-MANUAL". See "EXPRESSION PEDAL" (p. 71). This parameter can be also controlled by the aftertouch.</p>

Parameter	Setting	Explanation
Slope	12db/Octave, 24db/Octave	The slope of filter attenuation is usually quantified in decibels per octave.
Type	Low Pass, High Pass, Band Pass, Peak	<p>Low Pass : Attenuates the frequencies above a cutoff frequency, allowing low frequencies to pass through the filter.</p> <p>High Pass: Attenuates the frequencies below a cutoff frequency, allowing high frequencies to pass through the filter.</p> <p>Band Pass : The filter is applied over a narrow frequency range.</p> <p>Peak: The filter is applied over a specific center frequency.</p>
Low Freq	100Hz ~ 10.0KHz	Selects the frequency of the low range.
High Freq	100Hz ~ 10.0KHz	Selects the frequency of the High range.
Low Q	0.5 ~ 10.0	Move this parameter to adjusts the width of the area around the Low or High Frequency.
Hi Q	0.5 ~ 10.0	

18: Compressor

This filter that attenuates ("cut") some frequency range.

Parameter	Setting	Explanation
Threshold	-40dB ~ 0dB	The compression is activated only when the input signal exceeds the threshold level. Input levels above the threshold will be compressed, and input levels below the threshold will not be compressed.
Ratio	1:1 ~ inf:1	<p>This parameter determines how strong is the compression.</p> <ul style="list-style-type: none"> At 1:1, the compressor has no effect. For all other values the output signal will be compressed in according to the ratio value. At Inf:1, the compressor becomes a brick-wall limiter; once the signal hits the Threshold, the output level will no longer increase, regardless of the input level.
Knee Width	0.0 ~ 1.0	Increasing this value will produce a more soft volume change around the Threshold level.
Attack Time	0ms ~ 250ms	This parameter determines how quickly the compressor will take affect after the signal crosses above the threshold.
Release Time	0ms ~ 1000ms	This parameter controls how quickly the compressor will stop reducing volume level after the signal falls below the threshold.
Makeup	-24dB ~ -24dB	Allows you to boost the compressed signal. as compression often attenuates the signal significantly.
Stereo Link	Off, On	Set the parameter "On" to operate in stereo mode.

VIVO S10's Tone List

MEMO

The bold tone number indicates that it can be used for the Chord Enhancer function.

Num.	Name	PC	CC00 (MSB)
PIANO			
0001	USA PLT	1	60
0002	USA Live PLT	1	61
0003	USA Classic PLT	1	62
0004	USA Bright PLT	1	63
0005	USA Memory PLT	1	64
0006	USA Rev PLT	1	65
0007	Japan PLT	2	10
0008	Japan Live PLT	2	11
0009	Japan Classic PLT	2	12
0010	Japan Bright PLT	2	13
0011	Japan Memory PLT	2	14
0012	Japan Rev PLT	2	15
0013	VIVO Upright	1	2
0014	Elec.Grand	3	2
0015	E.Grand Trem	3	3
0016	Rock Piano	3	1
E.PIANO			
0017	EPBell Chorus PLT	5	107
0018	EPBell Phaser PLT	5	108
0019	EPBell Tremolo PLT	5	109
0020	EPBell OD PLT	5	110
0021	EPBell Phr+Trm PLT	5	111
0022	EPBell Flanger PLT	5	113
0023	EPBell HardOD PLT	5	114
0024	EPBell Bri+Cho PLT	5	115
0025	EPBell PLT	5	106
0026	EP Ballad PLT	5	122
0027	70s EP Chorus PLT	5	101
0028	70s EP Phaser PLT	5	102
0029	70s EP Tremolo PLT	5	103
0030	70s EP OD PLT	5	104
0031	70s EP Phr+Trm PLT	5	105
0032	70s EP Bright PLT	5	116
0033	70s EP Bri+Cho PLT	5	117
0034	70s EP Bri+Pha PLT	5	118
0035	70s EP Bri+Tre PLT	5	119
0036	70s EP Trm+OD PLT	5	120
0037	70s EP EQ+Trm PLT	5	121
0038	70s EP PLT	5	100
0039	Dirty EPBell PLT	5	112
0040	Dyno Stage	5	0
0041	Dyno Trem	5	7
0042	Dyno Bell	5	8
0043	Suitcase	5	1
0044	Phaser EP	5	2

Num.	Name	PC	CC00 (MSB)
0045	Suitcase Trem	5	9
0046	Suitcase Chr	5	10
0047	Suitcase Chr+Trm	5	11
0048	Wurly	5	5
0049	Trem.Wurly	5	6
0050	Soft E.Piano	5	3
0051	Bright E.Piano	5	4
0052	FM Full Tines	6	0
0053	FM E.Piano	6	1
PLUCKED/PERCUSSIVE			
0054	Doctor Clav	8	2
0055	Cool Clav	8	0
0056	Funky Clav	8	3
0057	Groovy Clav	8	1
0058	Wah-Wah Clav	8	4
0059	Drive Clav	8	5
0060	Vibraphone	12	0
0061	Marimba	13	0
0062	Celesta	9	0
ORGAN TW			
More than 100 preset. See "VIVO S10's Organ Preset List" (p. 83)			
STRINGS			
0063	Easy Strings	50	10
0064	FastOrchestra	50	4
0065	Attack Strings	49	2
0066	Choir Strings	52	1
0067	Large Strings	50	5
0068	MellowStrings	50	6
0069	Soft Strings	50	7
0070	5th Strings	50	8
0071	Slow Analog	50	9
0072	Orchestra	49	1
0073	80's Strings	52	0
0074	Syn. Strings	51	1
0075	Pizzicato	46	0
0076	Strings Pad	51	0
0077	StrTape1Dry	49	100
0078	StrTape1Rev	49	101
0079	StrTape1Cut	49	102
0080	Cllotape2Dry	43	103
0081	Cllotape2Rev	43	104
0082	Cllotape2Cut	43	105
0083	VlnsTape1Dry	50	100
0084	VlnsTape1Rev	50	101
0085	VlnsTape1Cut	50	102

Num.	Name	PC	CC00 (MSB)
PAD/CHOIR			
0086	Dexi Heaven	101	1
0087	Fanta Bell	101	0
0088	Warm Pad	90	0
0089	Soft Pad	90	1
0090	Square Pad	90	2
0091	90's Pad	51	2
0092	Space Vox	55	1
0093	Mmh Choir	53	0
0094	Choir Pad	54	1
0095	FlutTape1Dry	74	100
0096	FlutTape1Rev	74	101
0097	FlutTape1Cut	74	102
0098	MaleTape1Dry	53	106
0099	MaleTape1Rev	53	107
0100	MaleTape1Cut	53	108
BRASS/SYNTH			
0101	Full Brass	62	3
0102	Synth Brass	63	0
0103	Poly Brass	63	1
0104	Analog Brass	63	2
0105	Fat Syn Brass	63	3
0106	Trumpet Sect.	57	3
0107	Trumpet	57	2
0108	Horns	61	0
0109	Tenor Sax	67	0
0110	Alto Sax	66	0
0111	Flugelhorn	57	1
0112	Soprano Sax	65	0
0113	Classic Trumpet	57	0
0114	Lucky Lead	83	0
0115	Expressive	83	1
0116	ExpressiveFat	83	2
0117	ExpressiveBell	83	3
0118	Mellow Lyle	83	4
0119	Octave OSC	83	5
0120	Mellow Lead	83	6
0121	Clear Lead	83	7
0122	Saw Solo	83	8
0123	OSC Sync	83	9
0124	Mini Square	83	10
0125	Mini Triangle	83	11
0126	Triangle	83	12
0127	Pure Sine	83	13
0128	Saw Square	83	14
0129	Clear SawSqr	83	15

Num.	Name	PC	CC00 (MSB)
0130	70's SawSqr	83	16
0131	2600 Pulse 50	83	17
0132	2600 Pulse 20	83	18
0133	2600 PulseOD	83	19
0134	Clear PW	83	20
0135	OB Synth 1	81	0
0136	OB Synth 2	81	1
0137	OB Synth 3	81	2
0138	OB Synth 4	81	3
0139	Lyle Lead	81	4
0140	Super Saw	91	1
0141	Synth Lead 1	82	0
0142	Synth Mellow	82	1
0143	Synth Lead 2	82	2
0144	Synth Lead 3	82	3
0145	Synth Lead 4	82	4
0146	Fast Synth	91	2

Num.	Name	PC	CC00 (MSB)
0147	Poly Saw	91	3
0148	Euro Synth	91	4
0149	Euro Stack	94	0
0150	Poly Chord	94	1
0151	Synth Vox	55	0
0152	Urban Harp	47	1
GUITAR/BASS			
0153	Nylon Guitar	25	0
0154	Power GT.	30	1
0155	Muted GT.	30	2
0156	Jazz Guitar	27	0
0157	Rock Bass	35	1
0158	RockSlapBass	38	0
0159	RockSoftSlap	38	1
0160	Elec.Bass	34	2
0161	El.Bass Dark	34	3
0162	Soft Slap Bs	37	0

Num.	Name	PC	CC00 (MSB)
0163	Hard Slap Bs	37	1
0164	Pop Big Bass	34	4
0165	Pop Bass	34	5
0166	Pop Elec.Bass	34	6
0167	Fat Bass	34	7
0168	Contemp.Bass	34	8
0169	PalmMutingBs	34	9
0170	Old Muted	35	2
0171	Fretless Bass	36	0
0172	Upright Bass	33	7
0173	Pedal Bass	39	5
0174	Pedal DoubleBs	33	5
0175	Modular Bass	39	1
0176	Fat Bass	39	2
0177	Reso Bass	39	3
0178	Big Reso Bass	39	4
0179	FM Bass	40	3
0180	Synth Bass	39	0

VIVO S10's Organ Preset List

Num.	Upper Preset	Lower Preset	Pedal Preset
TW1/TW2			
0001	00 5320 000	00 4545 440	73
0002	00 4432 000	00 4423 220	85
0003	00 8740 000	00 7373 430	80
0004	00 4544 222	00 4544 220	08
0005	00 5403 000	00 6644 322	28
0006	00 4675 300	00 5642 200	
0007	00 5645 320	00 6845 433	
0008	00 6876 540	00 8030 000	
0009	32 7645 222	42 7866 244	
0010	88 8000 000	60 6000 000	
0011	87 8000 456	88 00 70 770	
0012	88 8800 000	83 8000 000	
0013	86 8600 008	00 4440 000	
0014	80 8800 008	20 7004 000	
0015	87 6543 211	00 6620 000	
0016	88 5324 588	00 7500 000	
0017	80 8000 008	80 8400 008	
0018	88 8233 211		
0019	86 4200 357		
0020	68 6040 000		
0021	88 8604 000		
0022	80 0008 888		
0023	00 8800 000		
FARF			
0001	08 0088 888	80 8000 008	80
0002	80 8000 808	08 0000 800	88

Num.	Upper Preset	Lower Preset	Pedal Preset
0003	80 8080 808	80 8080 008	
0004	08 0888 808	00 8088 800	
0005	08 8880 800	00 0880 080	
VX			
0001	38 8033 078	03 8800 367	88 0000 080
0002	80 8000 008	08 8000 008	08 0000 088
0003	88 8026 057	08 0800 557	88 0000 008
0004	08 0048 088	03 8000 667	88 0000 088
0005	88 0048 056	05 6700 475	80 0000 088
PIPE			
0001	00 8000 000	08 0000 000	800
0002	08 8000 000	88 0000 000	880
0003	08 8800 000	88 8000 000	888
0004	08 8880 000	88 8800 000	080
0005	88 8888 000	88 8808 000	808
USER 1			
0001	00 8000 000	08 0000 000	800 0000 000
0002	08 8000 000	88 0000 000	880 0000 000
0003	08 8800 000	88 8000 000	888 0000 000
0004	08 8880 000	88 8800 000	080 0000 000
0005	88 8888 000	88 8808 000	808 0000 000
USER 2			
0001	00 8000 000	08 0000 000	800 0000 000
0002	08 8000 000	88 0000 000	880 0000 000
0003	08 8800 000	88 8000 000	888 0000 000
0004	08 8880 000	88 8800 000	080 0000 000
0005	88 8888 000	88 8808 000	808 0000 000

Draw-faders MIDI Controls

CC number	Value	Description	Part	Draw-faders
CC 16	0 ~ 127	0 = 0 1 = 1 2 = 2 3 = 3 4 = 4 5 = 5 6 = 6 7 = 7 8 = 8	Main	Drawbars 16'
CC 17			Main	Drawbars 5 1/3'
CC 18			Main	Drawbars 8'
CC 19			Main	Drawbars 4'
CC 20			Main	Drawbars 2 2/3'
CC 21			Main	Drawbars 2'
CC 22			Main	Drawbars 1' 3/5'
CC 23			Main	Drawbars 1 1/3'
CC 24			Main	Drawbars 1'
CC 70			Lower	Drawbars 16'
CC 71			Lower	Drawbars 5 1/3'
CC 72			Lower	Drawbars 8'
CC 73			Lower	Drawbars 4'
CC 74			Lower	Drawbars 2 2/3'
CC 75			Lower	Drawbars 2'
CC 76			Lower	Drawbars 1' 3/5'
CC 77			Lower	Drawbars 1 1/3'
CC 78			Lower	Drawbars 1'
CC 14			Pedal	Drawbars 16'
CC 15			Pedal	Drawbars 5 1/3'
CC 25			Pedal	Drawbars 8'
CC 26			Pedal	Drawbars 4'
CC 27			Pedal	Drawbars 2 2/3'
CC 28			Pedal	Drawbars 2'
CC 29			Pedal	Drawbars 1' 3/5'
CC 30			Pedal	Drawbars 1 1/3'
CC 31			Pedal	Drawbars 1'

CC number	Value	Description	Percussion
CC 87	0 ~ 63~ 64 ~127	0 = Off, 1 = On	On/Off
CC 88		0 = Normal, 1 = Soft	Normal/Soft
CC 89		0 = Slow, 1 = Fast	Slow/Fast
CC 95		0 = 2nd, 1 = 3rd	2nd/3rd

CC number	Value	Description	Vibrato
CC 84	1,2,3,4,5,6	1 = V1, 2 = C1, 3 = V2, 4 = C2, 5 = V3, 6 = C3	Vibrato mode
CC 69	0 ~ 63~ 64 ~127	0 = Off, 1 = On	ON/OFF panel

CC number	Value	Description	Rotary Leslie
CC 80 (general purpose)	0 ~ 63~ 64 ~127	0 = Off, 1 = On	On/Off
CC 82 (general purpose)		0 = Slow, 1 = Fast	Slow/Fast
CC 81 (general purpose)		0 = Off, 1 = On	Brake On/Off

CC number	Value	Description	Overdrive
CC 83	0 ~ 63~ 64 ~127	0 = Off, 1 = On	On/Off
CC 92	1 ~ 100		Drive
CC 94			Tone
CC 90			Level

24 Troubleshooting

Symptom	Action	Page
Power turns automatically off.	This is normal and due to the Auto Power Off function. If necessary, set the parameter of the Auto Power Off function. If you don't need the power to turn off automatically, turn the "AUTO OFF" setting "Disable".	77
The instrument does not turn on.	Is the AC adaptor/power cord correctly connected to an AC outlet and to the VIVO S10? NOTE Do not use any AC adaptor or power cord other than the ones included. Doing so will cause malfunctions.	17
	Could you have turned the power on again immediately after turning the power off? Allow an interval of at least five seconds before turning the power on again.	-
No sound from the VIVO S10's OUTPUT sockets.	Did you switch the VIVO S10 on?	20
	Could the [VOLUME] knob be turned down? Select a higher setting.	-
	Could the volume be lowered by a pedal operation? Move the pedal fully "toe down" to maximize volume.	-
	Did you selected a sound (organ or orchestral)?	29, 24
The audio of one or more parts does not come out from the OUTPUTsocket (MAIN or SUB).	Could the part volume settings have been minimized? Check the "Level" setting of each part.	27
	Are the output destination settings (MAIN or SUB) correct for that part?	37
The volume level of the instrument is too low when it is connected to an amplifier.	Are you using a connection cable that contains a resistor? Use a connection cable that doesn't contain a resistor.	-
Insufficient volume from a device connected to the VIVO S10's INPUT jack.	Could you be using a connection cable that contains a built-in resistor? Use a connection cable that does not contain a resistor.	-
	Could the AUDIO IN Level be down? Select a higher setting.	74
Insufficient volume from or to a device connected to the VIVO S10's USB port.	Could the USB AUDIO Input Level be down? Select a higher setting.	74
	Could the USB AUDIO Output Level be down? Select a higher setting.	-
The pitch of the instrument is incorrect.	Is the "Tuning" or "Temperament" setting appropriate? Check the parameters.	73
	Did you transpose the instrument?	35
A "buzz" is heard from the external amplifier.	Is the external amplifier or other device used with the VIVO S10 connected to a different AC power outlet? Connect the amplifier or other device to the same AC outlet as the VIVO S10.	-
	The noise may be due to interference caused by the use of a mobile phone in close proximity to the instrument. Turn off the mobile phone, or use it further away from the instrument.	-
		-
Unable to read from/write to USB Memory.	Check the format of your USB Memory. The VIVO S10 can use USB Memory that has been formatted as FAT. If your USB Memory was formatted using any other method, please re-format it as MS-DOS FAT.	-
Can't save to USB Memory.	Could the USB Memory be write protected?	-
	Is there sufficient free space on the USB Memory?	-
Audio recording won't start or stops unexpectedly.	Is there sufficient free space on the USB Memory?	-
The songs won't play.	The file type of the song is not one of the file types that the VIVO S10 can play.	58
	It may be that the song data is damaged.	-
This "dexi-organ-xx" model name does not appear in the Bluetooth device list of your mobile device.	Have you made the instrument visible to other devices?	62
The music data played back by the mobile device cannot be heard through the VIVO S10.	Was the pairing function initiated between this unit and the mobile device?	61
The motorised draw-faders do not move automatically.	Is the "Motor Slider"parameter is set to ON? Please set the parameter to ON.	77

25 Specifications

ITEMS		VIVO S10
KEYBOARD TYPE	TP 400 Hybrid (with wood parts)	
TONE GENERATOR	T2L: Sampling and Modelling Technology	
MODELLING	Reactive to player articulation (Orchestral sounds)	
SAMPLING	XXL wave size, holophonic recording up to 15 seconds on lower piano notes	
SOUND WAVE FORMAT	24 bit linear - 48 KHz (Internal processing and DSP at 32 bit floating)	
DIGITAL ANALOG CONVERSION (DAC)	24 bit linear - 48 KHz, Dynamic Range, S/N:106dB	
MAXIMUM POLYPHONY	Unlimited with 320 Oscillator	
ORGAN TYPES	TW1, TW2, FARF, VX, PIPE + User1, User2 downloadable from website	
SOUNDS	Over 100 Organ Preset + 178 Sounds + User downloadable from website (Compatible with .sf2)	
TONE WHEEL	9 motorised	
MEMORY	Internal: 81; User: Unlimited loadable from USB Memory	
KEYBOARD MODE	4 Parts (MAIN, LOWER, COUPLED, PEDAL)	
TOUCH SENSITIVITY	7 Types + Fixed	
REVERB	24 Types	
EFFECTS	Rotary, Overdrive, Vibrato/Chorus for Organ + 12 independent DSP Effects (3 x 4 Parts) using "seamless changes" technology at effect recall	
MASTER EQUALIZER	3-band Digital Equalizer	
CHORD ENHANCER	Yes	
CONTROLLERS	Draw-faders (Organ TW, S1~S9 Reverb, Volume and EQ)	
	FX Encoder x 6	
	Aftertouch	
	Data Entry/Song Volume Encoder x 1	
		Master Volume Knob
PLAYER AUDIO	.wav, .aiff, .mp3, in all format, frequency and bit rate	
RECORDER AUDIO	.wav (48 kHz, 32-bit floating) on USB Memory	
MASTER TUNING	YES: 415,4Hz to 466,1 Hz (adjustable increments of 0,1 Hz) + 2 Preset (440 Hz, 442 Hz)	
TEMPERAMENT	9 Types + 3 User	
BLUETOOTH® WIRELESS CONNECTION	Streaming Audio Input, MIDI BLE 4.2	
RHYTHM PATTERNS	X MURE APP for i-Phone and i-Pad (FREE) with multitracks audio patterns	
CONNECTORS	DC IN socket	for supplied AC adaptor
	AUDIO IN jack	Stereo miniature phone type
	Unbalanced Output (L/Mono, R) jacks	Assignable as SUB OUTPUT 1/4-inch phone type x 2
	Balanced Output (L, R)	XLR type x 2
	Phones jacks	1 x Stereo miniature phone type 1 x Stereo 1/4-inch phone type
	USB COMPUTER (Type B port)	Digital Audio OUT on USB (24 bit, 48 KHz) Digital Audio IN on USB (24 bit, 48 KHz)
	USB MEMORY (Type A port)	To Host (MIDI), To Device (MEMORY)
	MIDI sockets	IN, OUT, THRU
	DAMPER Pedal (HOLD) socket	Progressive Damper Action Pedal with sympathetic resonance simulation (Accept on/off pedal also)
	ASSIGN 1 Pedal [FOOT] socket	Assignable
	ASSIGN 2 Pedal [EXPRESSION] socket	Assignable
ASSIGN 3 Pedal [MORPHING] socket	Assignable	
POWER SUPPLY	24V DC 2.5A , supplied AC/DC adaptor	
POWER CONSUMPTION	Stand By: < 0,2 W Maximum: 20 W "ErP" LEVEL VI for Echo efficiency on stand-by consumption	
DIMENSIONS	1270 (W) x 354 (D) x 130 (H) 50 (W) x 13-15/16 (D) x 5-1/8 (H) inches	
WEIGHT	20 kg (excluding AC adaptor) 44 lbs 2 oz (excluding AC adaptor)	
SUPPLIED ACCESSORIES	Quick Guide AC adaptor (DEXIBELL DYS602-240250 or DEXIBELL DYS865-240250) Damper Pedal (DEXIBELL DX CP1) Music Rest	
OPTIONS (sold separately)	DX HF7 Professional Headphones	

- The **Bluetooth®** word mark and logos are registered trademarks owned by Bluetooth SIG, Inc. and any use of such marks by PROEL is under license.

NOTE

In the interest of product, the specification and description are subject to change without notice.

26 Index

Simboli

A

AC Adaptor	17
Adding a Library	41
Audio Backing Tracks	61
AUDIO INPUT	74
AUTO OFF	21

B

Bluetooth®	62
------------------	----

C

Computer	18
CONTROLS	70
COUPLED FX	69
COUPLED SETTING	68
Cursor	22
Cursor Operation	22

D

DC IN jack	17
Demo	21
Digital Player devices Connecting	18
Display	22
Draw-faders	30

E

Effect Reverb Effect	34
Exporting a Sound Set	44

F

Factory Sounds	38
File name Assigning the Name You Specify	23

G

GLOBAL	77
--------------	----

H

Harmonic Percussion	32
Headphones	18

I

Import Importing Memory Set	53
Importing a Sound Set	44

J

K

KEYBOARD TOUCH	69
----------------------	----

L

LOWER FX	69
----------------	----

LOWER SETTING	69
---------------------	----

M

MASTER EQ	69
MASTER TUNE	72
Memories Importing Memory Set from the USB Memory into Internal Memory.	53
Recalling your settings from an USB Memory	52
Recalling your settings from Internal Memory	50
Renaming a Memory	53

MEMORY	74
--------------	----

MIDI	19,75
------------	-------

MIDI zones	59
------------------	----

Morphing	30
----------------	----

Music Rest	20
------------------	----

N

O

Organ Section	29
Organ Types	29
Overdrive	31

P

Parameters GLOBAL	77
passkey	62
PEDAL FX	69
PEDAL Part	26
Pedals	17
Player Devices	18
Power On/Off	20
Turning the Power On/Off	20
Presettled Organ	29

Q

Quick Guide	14
-------------------	----

R

Record Recording Your Performance	58
Rename Renaming a Memory	53
Reverb Reverb Effect	34
REVERB	69

S

SETTING SETTING Parameters Group	68
Song Playing a Song	55
Sound Library	40
Sounds Personalizing Your Sounds T2L	45

Sound Setup	44
-------------------	----

Specifications	86
----------------------	----

Split Splitting the Keyboard Range and Playing Two Different Tones	26,27
--	-------

SPLIT MODE	69
------------------	----

T

T2L EDITOR	69
------------------	----

T2L-Modelling	45
---------------------	----

TEMPERAMENT	73
-------------------	----

Tones Grand Piano Mode	24
---------------------------------	----

tonewheel	29,43
-----------------	-------

TRANPOSE	69
----------------	----

Troubleshooting	85
-----------------------	----

TUNE MASTER TUNE	72
---------------------------	----

TUNING	72
--------------	----

TW ASSIGN	30
-----------------	----

U

USB FORMAT	20
------------------	----

USB Memory Connecting an USB Memory	19
Importing Memory Set from the USB Memory into Internal Memory.	53
Recalling your settings from an USB Memory	52

V

W

Wireless Already Paired Mobile Device	63
--	----

X

X MURE	61
--------------	----

Y

Z

Zone (MIDI)	59
-------------------	----



This product complies with the requirements of EMC Directive 2014/30/EU.

For European Countries

For Canada

NOTICE

This Class B digital apparatus meets all requirements of the Canadian Interference-Causing Equipment Regulations.

AVIS

Cet appareil numérique de la classe B respecte toutes les exigences du Règlement sur le matériel brouilleur du Canada.

IMPORTANT NOTICE FOR THE UNITED KINGDOM

IMPORTANT: THE WIRES IN THIS MAINS LEAD ARE COLOURED IN ACCORDANCE WITH THE FOLLOWING CODE.

BLUE: NEUTRAL
BROWN: LIVE

As the colours of the wires in the mains lead of this apparatus may not correspond with the coloured markings identifying the terminals in your plug, proceed as follows:
The wire which is coloured BLUE must be connected to the terminal which is marked with the letter N or coloured BLACK.
The wire which is coloured BROWN must be connected to the terminal which is marked with the letter L or coloured RED.
Under no circumstances must either of the above wires be connected to the earth terminal of a three pin plug.

European Community Declaration of Conformity

English	Hereby, DEXIBELL, declares that this VIVO S10 is in compliance with the essential requirements and other relevant provisions of Directive 2014/53/EU.
Italiano [Italian]	Con la presente DEXIBELL dichiara che questo VIVO S10 è conforme ai requisiti essenziali ed alle altre disposizioni pertinenti stabilite dalla direttiva 2014/53/UE.
Français [French]	Par la présente DEXIBELL déclare que l'appareil VIVO S10 est conforme aux exigences essentielles et aux autres dispositions pertinentes de la directive 2014/53/UE.
Deutsch [German]	Hiermit erklärt DEXIBELL, dass sich das Gerät VIVO S10 in Übereinstimmung mit den grundlegenden Anforderungen und den übrigen einschlägigen Bestimmungen der Richtlinie 2014/53/EU befindet.
Nederlands [Dutch]	Hierbij verklaart DEXIBELL dat het toestel VIVO S10 in overeenstemming is met de essentiële eisen en de andere relevante bepalingen van richtlijn 2014/53/EU.
Español [Spanish]	Por medio de la presente DEXIBELL declara que el VIVO S10 cumple con los requisitos esenciales y cualesquiera otras disposiciones aplicables o exigibles de la Directiva 2014/53/UE.
Português [Portuguese]	DEXIBELL declara que este VIVO S10 está conforme com os requisitos essenciais e outras disposições da Directiva 2014/53/UE.
български [Bulgarian]	С настоящото DEXIBELL декларира, че това устройство VIVO S10 е в съответствие със съществените изисквания и други приложими разпоредби на Директиви 2014/53/EC
Hrvatski [Croatian]	DEXIBELL ovim putem izjavljuje da je ovaj uređaj VIVO S10 sukladan osnovnim zahtjevima i ostalim bitnim odredbama Direktiva 2014/53/EU
Česky [Czech]	DEXIBELL tímto prohlašuje, že tento VIVO S10 je ve shodě se základními požadavky a dalšími příslušnými ustanoveními směrnice 2014/53/EU.
Dansk [Danish]	Undertegnede DEXIBELL erklærer herved, at følgende udstyr VIVO S10 overholder de væsentlige krav og øvrige relevante krav i direktiv 2014/53/EU.
Eesti [Estonian]	Käesolevaga kinnitab DEXIBELL seadme VIVO S10 vastavust direktiivi 2014/53/EL põhinõuetele ja nimetatud direktiivist tulenevatele teistele asjakohastele sätetele.
Ελληνική [Greek]	ΜΕ ΤΗΝ ΠΑΡΟΥΣΑ DEXIBELL ΔΗΛΩΝΕΙ ΟΤΙ ΤΟ VIVO S10 ΣΥΜΜΟΡΦΩΝΕΤΑΙ ΠΡΟΣ ΤΙΣ ΟΥΣΙΩΔΕΙΣ ΑΠΑΙΤΗΣΕΙΣ ΚΑΙ ΤΙΣ ΛΟΙΠΕΣ ΣΧΕΤΙΚΕΣ ΔΙΑΤΑΞΕΙΣ ΤΗΣ ΟΔΗΓΙΑΣ 2014/53/ΕΕ.
Íslenska [Icelandic]	Hér, DEXIBELL, því yfir að þetta VIVO S10 tæki er í samræmi við grunnkröfur og önnur viðeigandi ákvæði tilskipana 2014/53/ESB
Latviešu valoda [Latvian]	Ar šo DEXIBELL deklarē, ka VIVO S10 atbilst Direktīvas 2014/53/ES būtiskajām prasībām un citiemar to saistītajiem noteikumiem.
Lietuvių kalba [Lithuanian]	Šiuo DEXIBELL deklaruojau, kad šis VIVO S10 atitinka esminius reikalavimus ir kitas 2014/53/ES Direktyvos nuostatas.
Malti [Maltese]	Hawnhekk, DEXIBELL, jiddikjara li dan VIVO S10 jikkonforma mal-htigijiet essenzjali u ma provvedimenti oħrajn rilevanti li hemm fid-Dirrettiva 2014/53/UE.
Magyar [Hungarian]	Alulírott, DEXIBELL nyilatkozom, hogy a VIVO S10 megfelel a vonatkozó alapvető követelményeknek és az 2014/53/EU irányelv egyéb előírásainak.
Norsk [Norwegian]	Herved DEXIBELL, erklærer at denne VIVO S10 enheten, er i samsvar med de grunnleggende kravene og andre relevante bestemmelser i direktivene 2014/53/EU
Polski [Polish]	Niniejszym DEXIBELL oświadcza, że VIVO S10 jest zgodny z zasadniczymi wymogami oraz pozostałymi stosownymi postanowieniami Dyrektywy 2014/53/UE.
Română [Romanian]	Prin prezenta, DEXIBELL declară că acest dispozitiv VIVO S10 este în conformitate cu cerințele esențiale și alte prevederi relevante ale Directivei 2014/53/UE
Slovenščina [Slovenian]	DEXIBELL izjavlja, da je ta VIVO S10 v skladu z bistvenimi zahtevami in ostalimi relevantnimi določili direktive 2014/53/EU.
Slovenčina [Slovak]	DEXIBELL týmtovyhlasuje, že VIVO S10 spĺňa základné požiadavky a všetky príslušné ustanovenia Smernice 2014/53/EU.
Suomi [Finnish]	DEXIBELL vakuuttaa täten että VIVO S10 tyyppinen laite on direktiivin 2014/53/EU oleellisten vaatimusten ja sitä koskevien direktiivin muiden ehtojen mukainen.
Svenska [Swedish]	Härmed intygar DEXIBELL att denna VIVO S10 står i överensstämmelse med de väsentliga egenskapskrav och övriga relevanta bestämmelser som framgår av direktiv 2014/53/EU.

DEXIBELL

DEXIBELL

is a brand of

PROEL SPA

(Worldwide Headquarters)

Via alla Ruenia, 37/43

64027 Sant'Omero (TE) - ITALY

Tel. +39 0861 81241

Fax +39 0861 887862

P.I. 00778590679

N.Reg.AEE IT 08020000002762

info@dexibell.com

dexibell.com

