



F A C T  R Y

USER MANUAL

TABLE OF CONTENT

OVERVIEW

What is Factory?

Factory user interface / architecture

PRESETS

The preset browser

Selecting / loading presets

Save presets

Undo/redo

FACTORY IN DETAIL

Signal path

Oscillators

- Oscillator models

Mixer

Filter

- Filter models

Drive

Output

Modulators

- ENV 1 and ENV 2
- LFO 1 and LFO 2
- Sample & Hold

Modulation matrix

- Function principle
- Using Factory's modulation matrix
 - Select modulation sources
 - Select modulation destinations
 - Create modulation connections / modulation depth
 - Reset the matrix / delete all modulation paths
 - Modifier / matrix modulation
 - Mod Tweak and Mutate functions

Sequencer

Articulation

- Pitch Factory
- Arpeggiator
- Gate

Effects

- Groove Delay
- Pitch Delay
- Reverse Delay
- Corpus
- Pianoverb
- Shimmer
- Whiteverb
- Equalizer
- Stereo Filter
- Dynamic Filter
- Chorus
- Phaser
- Flanger
- Shatter
- Lofizer
- CompMax
- Modulating effect parameters

Settings

- Clock
- MIDI
- Sound

Realtime controllers

MIDI CC assignment

INSTALLATION

Windows

OSX

Uninstalling

Authorisation

Host integration

- Cubase
- Ableton Live
- Pro Tools
- Studio One
- Logic
- Sonar
- FL Studio
- MIDI remote control via host

CONTACT

OVERVIEW

What is Factory?

Watch video teaser

Picture this: A modular synthesizer that provides totally unlimited connectivity between all its modules. Now picture this: In addition to that, you could modulate all those modulation paths on their part – individually, or all at the same time, in very precise ways or at random. Finally imagine this synthesizer would be polyphonic and completely programmable – this is exactly what Factory is about!

Factory streamlines the well-known concept of a modulation matrix and employs an interconnection system as a key element that combines maximum routing flexibility with playful and intuitive access. As it happens to be the case, Factory is capable of generating sounds of a huge sonic spectrum using various oscillator, filter, and effects modules. From well-known and popular bread-and-butter sounds to highly bizarre effects and even entire drum loops, almost anything is possible. Extremely powerful modulation options can be routed to almost every parameter via the modulation matrix. This includes envelopes, LFOs, arpeggiator, and even a four-track step sequencer.

Finding the perfect sound for each genre is incredibly easy and efficiently executed by using the innovative and clearly structured preset browser.

Factory works as a plug-in for all common DAW hosts or as stand-alone application on Mac and Windows PCs. We would like to thank you for purchasing Factory. We appreciate your choice very much and hope you will have loads of fun with your new instrument.

Factory User interface / architecture

Factory' user interface is divided into four main sections:

- In the top menu bar you will find the current preset name as well as several buttons related to preset management and a undo/redo function.
- The modules of Factory' signal path , together with the mod matrix, can be found center-screen.
- Below the signal path window, five more windows with additional modules are located: „Modulators“ (modulation sources), „Sequencer“ (4-track step-sequencer), „Articulation“ (arpeggiator as well as parameters to control articulation with), „Effects“ (three multi-effects modules) and „Settings“ (MIDI-settings, global functions). These windows are accessed via tabs.
- At the very bottom you will find the realtime controllers such as keyboard with pitch and mod wheels as well as the Morph fader.



PRESETS

In stand-alone mode, right after booting Factory will load the last active setting, i.e. Factory will exactly reproduce the current state before the last shutdown.

In plug-in mode, Factory will load a default preset. You can define any setting as your default preset. All preset handling functions can be found in Factory's header.



The preset browser: selecting / loading presets:

Arktis Clicking on the preset name in the header will open up the preset browser.

 A screenshot of the Factory preset browser interface. The interface is divided into several sections:

- TRACE**: A grid of preset categories like 'Analog Beat', 'Distorted Dark', 'Simple Percussive', etc.
- EDIT**: A section for editing the selected preset, showing 'Arktis' with fields for 'Author' (Sugar Bytes) and 'Rating' (5 stars).
- RESULTS**: A table listing various presets with columns for Name, Author, and Rating. The 'Arktis' preset is highlighted in blue, and a hand cursor is pointing at it.
- PGM LIST**: A button to view the program list.

Name	Author	Rating
12 Strings MW	Sugar Bytes	● ● ● ● ●
80ies Bass	Sugar Bytes	● ● ● ● ●
Airwave	Sugar Bytes	● ● ● ● ●
Aldehyp	NOAUTHOR	● ● ● ● ●
Analog Strings	Sugar Bytes	● ● ● ● ●
Arktis	Sugar Bytes	● ● ● ● ●
Bad Axxe MW	Sugar Bytes	● ● ● ● ●
BassKick	NOAUTHOR	● ● ● ● ●
BeatMeUp MW	Sugar Bytes	● ● ● ● ●
BeatMeUp MW	Sugar Bytes	● ● ● ● ●
BeatSequencer	Sugar Bytes	● ● ● ● ●
Bells	Sugar Bytes	● ● ● ● ●
Bite Lead	Sugar Bytes	● ● ● ● ●
Blowjob MW	Sugar Bytes	● ● ● ● ●
Blowjob MW	Sugar Bytes	● ● ● ● ●
Blumenladen	Sugar Bytes	● ● ● ● ●
BongoClap	Sugar Bytes	● ● ● ● ●
Booom MW	Sugar Bytes	● ● ● ● ●
Bright Choirish	Sugar Bytes	● ● ● ● ●
Choirbeast	Sugar Bytes	● ● ● ● ●
Choirbeast2	Sugar Bytes	● ● ● ● ●
Choirmalet	Sugar Bytes	● ● ● ● ●
Classic Bass MW	Sugar Bytes	● ● ● ● ●
Classic Bass MW	Sugar Bytes	● ● ● ● ●
Classic Lead MW	Sugar Bytes	● ● ● ● ●

The preset browser is used to sort and archive your presets by using specific keywords or **tags**. The browser provides several search functions to retrieve presets which have specific properties, labelled accordingly using the corresponding tags. If you need e.g. a distorted synth bass, you can search the entire preset pool for this type of sound. This will save you a lot of time.

Clicking on the **preset name** will load the preset. Have fun! Make use of the mod wheel and/or the morph fader while trying out the presets – numerous presets hide some nice surprises for you...

Searching presets



In the upper left you will find a large window labelled **TRACE**. It provides several functions for tagging and searching presets described here:

The Cloud function



Click the **cloud button**. The trace window now shows all **tags** (keywords) that are currently being used in your entire preset library. The **size of each tag** represents how frequently this specific quality is used to classify presets in the library.

In the figure below, „Sequenced“ presets are available in a large number while only a few e.g. „FM“ or „Morph“ presets can be found in the library.

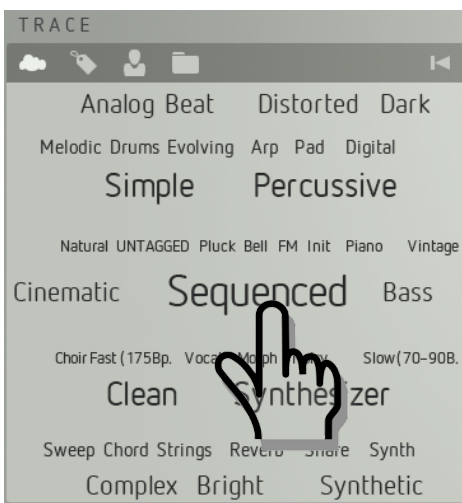

The selection procedure is executed by clicking the desired tag. The chosen tag (e.g. „Sequenced“) is high-lighted in blue. The Results list on the right of the preset browser now shows only presets that make use of the tag „Sequenced“.

To further refine the search, you can click another tag (e.g. „Distorted“). The selection will now be narrowed down to presets that use these two tags. The tag selection in the cloud window will also be updated.

Since each preset is tagged with four keywords (or at least should be), you can refine the search four times by clicking more tags (e.g. „Bright“). Clicking a blue high-lighted tag, resets the last selection.

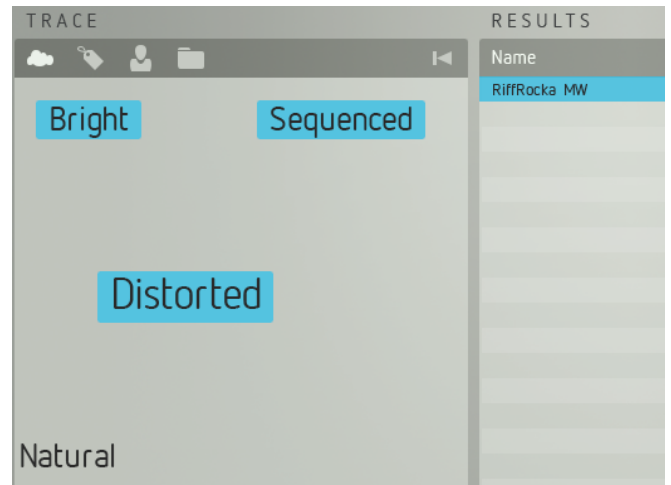
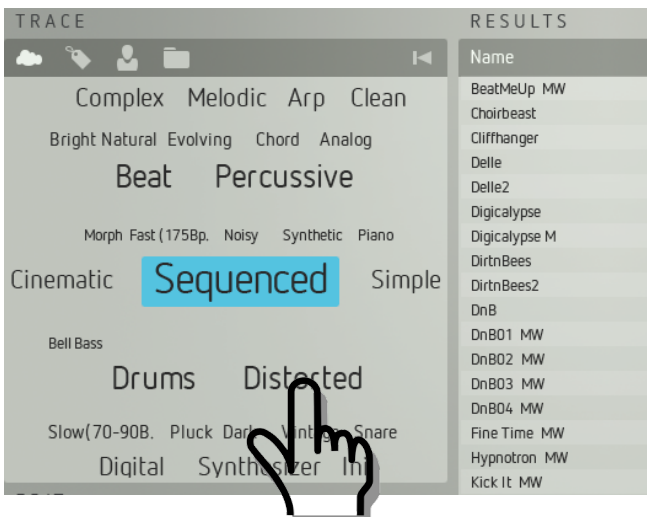

A click on the desired **preset name** in the **RESULTS** list will load it. Have fun! Make use of the mod wheel while trying out the presets – numerous presets hide some nice surprises for you...



Clicking on the **Backwards** symbol above the trace window will reset the current search.

Important: In order to make effective use of the preset browser, you are required to tag all presets as accurately and meaningfully as possible. You should always use all four tags and make sure they describe the character of the presets as accurately as possible.

You can create your own tags (see below) as well but please keep in mind that the cloud window might look a bit confusing when a large amount of tags is in use. To keep life simple, we advise you to stick to the tags suggested by the system as often as you possibly can.

Tag presets

Assigning tags:

You can always tag presets or change existing tags by using the functions in the **EDIT** window. Simply click on the arrow symbol of the tag. A selection window will pop up. Click on the desired tag – done. This change will immediately be stored in the preset – no extra preset saving required.

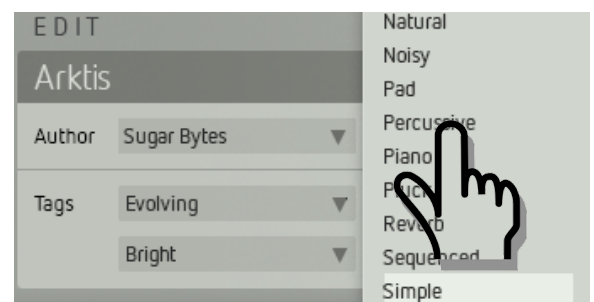
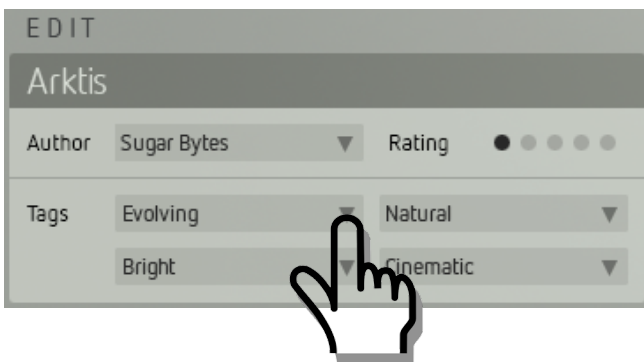

Creating new tags:

You can create new tags. Click into the name of a tag field and enter a new and meaningful tag name (“mind-blowing” is not always a good starting point...). Each new tag will be added to the cloud (and list). Again – please bear in mind that the cloud window might become a bit confusing when a large amount of tags is in use. For simplicity’s sake, we advise you to stick to the given tags as often as you can.

Please note: You cannot erase existing tags directly. But tags that are not connected to a preset anymore – e.g. because all the presets that used them have been erased – are erased from the preset browser after Factory’s next launch.

Author:

Here, you can select the preset author’s name, enter a new name or change the existing one. The preset browser can sort the presets by author.

Rating:

Here, you can rate the presets’ qualities from one to five. The preset browser can sort the presets by rating. This way it is pretty easy to retrieve your favourite presets quickly.

Sorting functions

In addition to the cloud ([please see above](#)), Factory features more sorting functions that make the task of retrieving specific presets easier.



When clicking on the **tag** symbol, the trace window will display all existing tags as a list. The digit shows the number of presets that use the respective tag. Here, too, you can refine your search by using up to four tags.

TRACE		
Analog(17)	FM(6)	Strings(4)
Arp(8)	Fast (175Bpm)(2)	Sweep(4)
Bass(15)	Init(4)	Synth(2)
Beat(15)	Melodic(12)	Synthesizer(18)
Bell(6)	Morph(2)	Synthetic(13)
Bright(13)	Natural(10)	UNTAGGED(1)
Choir(2)	Noisy(2)	Vintage(6)
Chord(3)	Pad(8)	Vocal(1)
Cinematic(18)	Percussive(20)	
Clean(20)	Piano(6)	
Complex(11)	Pluck(8)	
Dark(10)	Reverb(1)	
Digital(9)	Sequenced(33)	
Distorted(14)	Simple(23)	
Drums(9)	Slow(70-90Bpm)(1)	
Evolving(9)	Snare(2)	



By clicking on the **author** symbol, the trace window will present a list of all existing preset authors. Clicking on the desired author name will further refine the search.



By clicking on the **folder** symbol, the trace window will display a list of all folders on your hard drive that contain Factory presets. Clicking on the desired folder name will further refine your search as well.

Results list

The results list displays the results yielded by the search, performed in the trace window. You can change the order of the presets by:

- **Name:** The resulting presets will be sorted alphabetically.
- **Author:** The resulting presets will be sorted alphabetically by the author's name.
- **Rating:** The resulting presets will be sorted by rating score.

RESULTS		
Name	Author	Rating
BeatMeUp MW	Sugar Bytes	● ● ● ● ●
BeatMeUp MW	Sugar Bytes	● ● ● ● ●
BeatSequencer	Sugar Bytes	● ● ● ● ●
Choirbeast2	Sugar Bytes	● ● ● ● ●
Cliffhanger	Sugar Bytes	● ● ● ● ●
Delle	Sugar Bytes	● ● ● ● ●
Delle2	Sugar Bytes	● ● ● ● ●
DnB	Sugar Bytes	● ● ● ● ●
DnB02	Sugar Bytes	● ● ● ● ●
DnB03	Sugar Bytes	● ● ● ● ●
DnB04	Sugar Bytes	● ● ● ● ●

Program (PGM) List

Click on the **arrow** symbol right beside „Pgm List“. A list with 128 positions will open up (in its default state, it is empty). A Program list can e.g. be used to prepare a preset selection/sequence for a live gig.

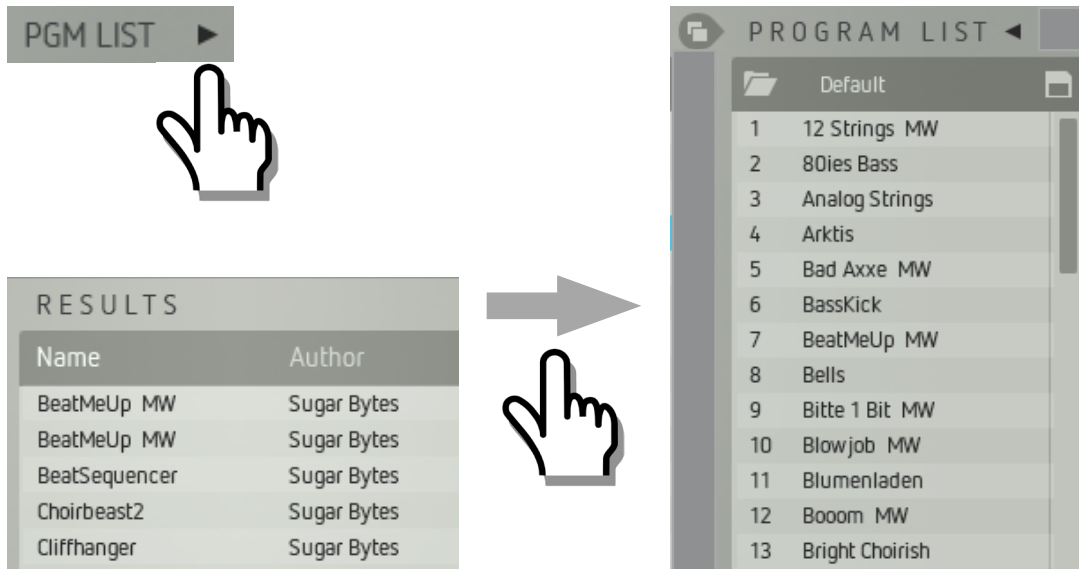



You can now drag'n'drop presets from the **results** list into the **program** list. Depending on its position there (1 – 128), each preset will respond to the respective MIDI program change command. If e.g. the preset „Bells“ is on position 58, an incoming MIDI program change command #58 will load the preset „Bells“.

You can change the order of the presets within the program list simply by using drag'n'drop.

 Clicking this symbol, automatically fills the program list with the presets currently contained by the results list (of course this works only for the first 128 presets).

 After clicking into the **name**, you can enter a new name or rename the current program list.

 When clicking on the **disk** symbol (right), the file browser of your computer will open up. Now you can name the current program list and save it in a memory slot of your choice.

 When clicking on the **folder** symbol (left), the file browser of your computer will open up again. Now you can load a previously saved program list.

 Click on the **arrow** symbol again to close the program list.

Closing the preset browser

 Clicking on the **X** symbol (top right) or the **preset name** (in the header) will close the preset browser

Previous / next Preset

 Clicking on the **short arrow buttons in the header** will load the next resp. previous preset in the current results list. This allows you to cycle through the presets of a search one by one even when the preset browser is closed.

Save Presets

You can save your current settings at every time as a preset.



Click on the **disk** symbol right in Factory's **header**. A window with preset name and tags will pop up. As described in the section „[tag presets](#)“, you can name, tag and rate the preset here.

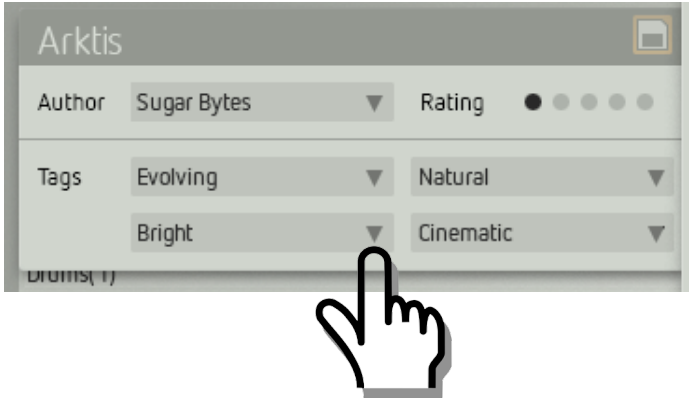

Next click on the **flashing disk** symbol. The file browser of your computer will open up. Now you can save the current preset in a memory slot of your choice. We advise to use Factory's default preset folder structure.

To cancel the preset save procedure, simply click somewhere onto Factory's main window. The preset save windows will close and the save function is aborted.

Undo / Redo function



These buttons (in the header) set back or redo your last operating step.

Preset random selection

Clicking the blue colored gear of the Factory logo loads a randomly selected preset.



FACTORY IN DETAIL

Signal path

In this section, you will be introduced to Factory’s sound generation with all its functions. Factory employs a classic subtractive signal path but the modules in their own right, and the way they interact, are pretty innovative. Two audio oscillators with ten synthesis models each, one sub-oscillator, and a noise source provide the audio signals. They are combined and ring-modulated if so desired, shaped further by a multimode filter and/or a drive section as well as a level modulation unit. In addition to that, Factory features a powerful effects section with three multi-effects modules running in series.

As modulation sources you will find various audio signals (oscillators, noise) and modulators. The latter provide two envelopes and LFOs as well as a very powerful sample + hold module. The interconnection between modulation sources and destinations is executed using the central modulation matrix.

The four-track step sequencer and the arpeggiator do not only create melodies – they are entirely integrated into the sound generation via the matrix.

The Pitch Factory determines the tonal scaling of modulations and control the function of the pitch and mod wheels. „Intonation“ creates a bit of animation and randomness in Factory’s sound.

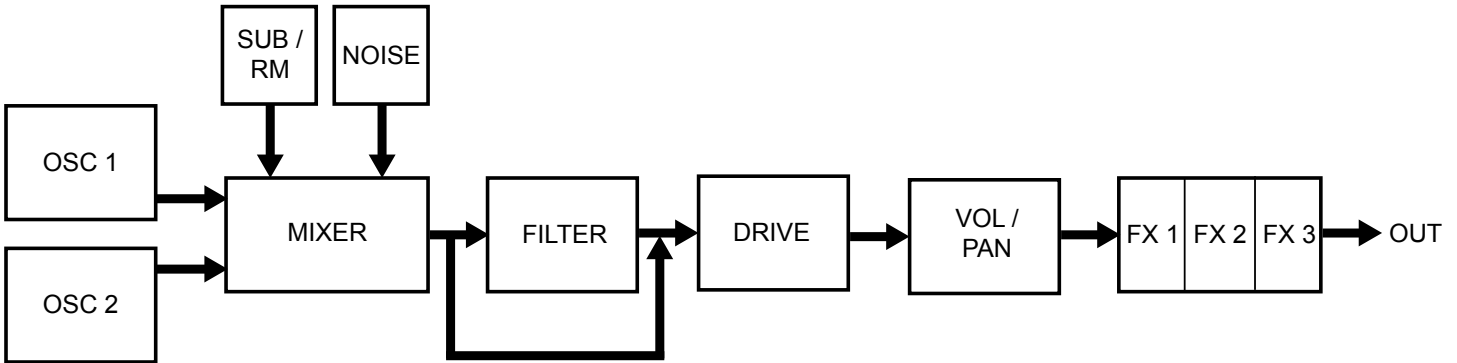

Oscillators

Watch video

The oscillators OSC 1 and OSC 2 are Factory's main signal sources. They are identical with each other and provide ten different oscillator models each, with very different sonic capabilities.

The parameters/controls of the oscillator models are a little different here and there. However, three identical functions appear on all oscillator models:

- **Tuning:**
 - the left number controls the pitch of the oscillator by +/- 36 semitones (+/-3 octaves).
 - the right number detunes the oscillator by cents (0 to 99 cent)
- **Pitch Track:** (keyboard symbol) connects / disconnects the pitch control to/from the keyboard. The latter is useful for e.g. drum sounds.



Oscillator models

Clicking on the name of the oscillator model will open up a selection window. Load the desired model by clicking on it. You can cycle through the different models using the arrow buttons.

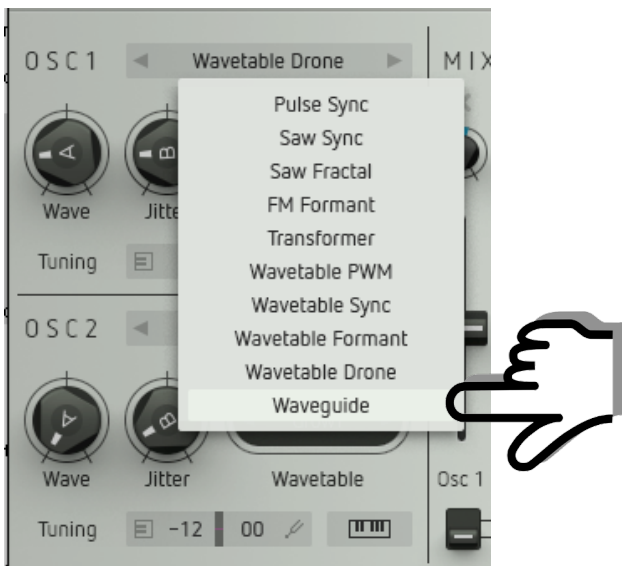

Pulse Sync

Produces a signal made up of several pulsewaves synced with each other. The sound is dense and vivid. By and large, this is the equivalent of a classic, fat-sounding analog pulsewave.

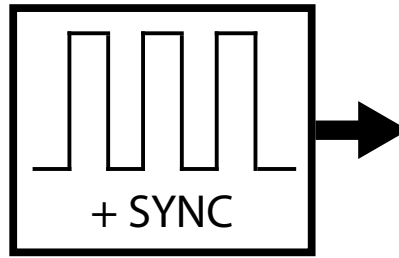

- **Sync Freq:** Controls the sync frequency and thus the fundamental timbral character.
- **Key Track:** Controls to what extent the sync frequency – and thus the sound – will change, depending on the pitch played.
- **Pulse Width :** Controls the pulsewidth of the pulsewave. A symmetrical squarewave is generated at center setting. By turning the knob clockwise (or back), the ratio between peaks and troughs will change increasingly.

Saw Sync

Produces a signal made up of several sawtooth waves, synced with each other. The sound is very bright and warm. It largely resembles a classic, analog sawtooth wave (and fat-sounding it is, too. We thought we should point this out).

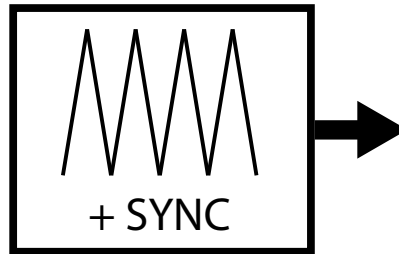

- **Sync Freq:** Controls the sync frequency and thus its fundamental timbral character.
- **Key Track:** Controls to what extent the sync frequency – and thus the sound – will change depending on the pitch played.

Saw Fractal

Produces a sawtooth wave that gets chopped up into tiny fragments at a set rate, which is then fed back into the oscillator. Depending on the setting of these controls, the sound can range somewhere between thin and static and dense and shimmering.

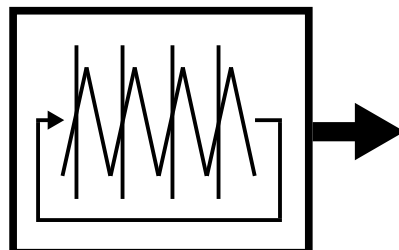
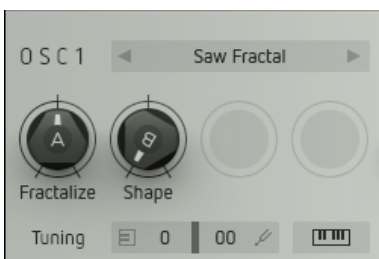

- **Freq:** Controls the frequency of the „fragmentation“ of the signals or, in other words, the size of the chopped-up segments.
- **Shape:** Controls feedback level and polarity. The waveform shape vaguely resembles a sawtooth wave („clockwise“) or a pulsewave („counter clockwise“).

FM Formshift

This oscillator model features Phase Modulation (much more popular under the not quite correct term „frequency modulation / FM“, but we mustn't use this nomenclature here...). A sinewave, modulated by a second one, resulting in a very versatile and rich sound. The frequency ratio of both sinewaves is scaled – thus all sounds can be played harmonically tuned across the whole note range.

But that is not all there is: The result of the phase modulation model will be processed further, using formant shift.

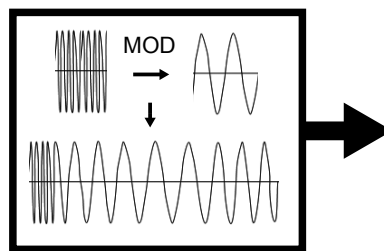

- **Amount:** Controls the amount of phase modulation. Turning Amount clockwise increasingly generates more overtones.
- **Feedback:** Distorts the resulting waveshape from sine-like (Amount and Feedback fully counter-clockwise) to sawtooth-like (Feedback fully clockwise).
- **Shift:** Shifts the formants of the resulting PM waveform and thus alters its fundamental timbral character
- **Ratio:** Controls a scaled frequency ratio between both basic waveforms.

Transformer

A granular oscillator. Here, you can import a sample of your choice. The sample will be automatically analysed and transformed into a wavetable which is then played back in segments as a looped waveform. By applying this process, it is possible to play the sample across a theoretically unlimited note range. Feel free to try out any kind of sound material for more Metal Machine Music. Even unusual sounds, e.g. vocal samples of you singing under the shower, may yield interesting results. Or not.

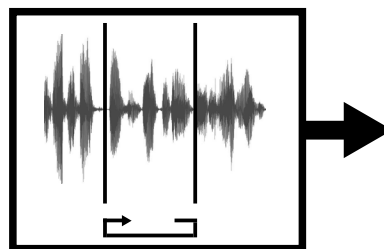

- **Position:** Shifts the section of the sample that will be looped and played back.
- **Formant:** Shifts the formants of the sample and thus alters its fundamental timbre.



To load an audiofile, click on the small **waveform display**. Your computers file browser will open up. Select an audiofile of your choice anywhere on your hard disk and load it into Factory’s oscillator by another click.
 Factory will accept the audio file formats wav, aif, and mp3.

By clicking on the **sample name** under the sample display, you will directly open up Factory’s sample content, organised in groups and samples.

Using the **arrow symbols**, you can step through the samples in Factory’s sample folder.

Factory’s sample content is located on your hard disk here:

„Documents/Sugar Bytes/Factory/Samples“ (OSX)
 „user/documents/sugar bytes/factory “ (Windows)

Wavetable PWM

This oscillator model uses wavetable synthesis, i.e. a series of different waveforms that is played back sequentially. In addition to that, the resulting sound will get a pulsewidth-modulation treatment.

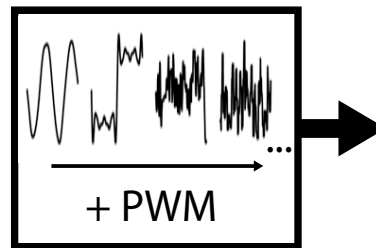

- **Wave:** Defines the playback position within the selected wavetable and thus changes its timbral character.
- **Pulse Width:** Controls the pulsewidth of the waveform. A symmetrical wave is generated at the center setting. By turning the knob clockwise (or back), the ratio between peaks and troughs will change increasingly.



By clicking on the **wavetable name**, a selection window will open up. It shows Factory’s wavetable content, content, organised in groups and wavetables. You can select and load a wavetable into the oscillator by another click on the mouse key.

Click on the short **arrow symbols** to step through the wavetables in Factory’s wavetable folder

Wavetable Sync

This oscillator model also uses wavetable synthesis. In addition to that, the resulting wave is synced to another wave running at a higher frequency. This yields a completely new waveshape.

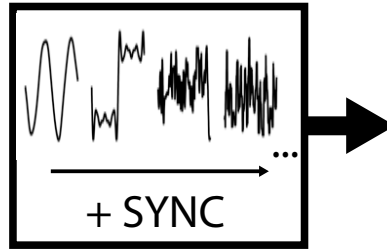

By clicking on the **wavetable name**, a selection window will open up. You can select and load a wavetable into the oscillator by another click on the mouse key ([please see screenshot on previous page](#)).

- **Wave:** Defines the playback position within the selected wavetable and thus determines its timbral character.
- **Sync Freq:** Controls the sync frequency and thus the timbral character, i.e. the sound grows increasingly brighter.

Wavetable Formant

Yet another wavetable oscillator. This one adds formant shifting to the produced waveform. The sound is quite different from the other wavetable models. It can be useful for the creation of e.g. vocal-like sounds.

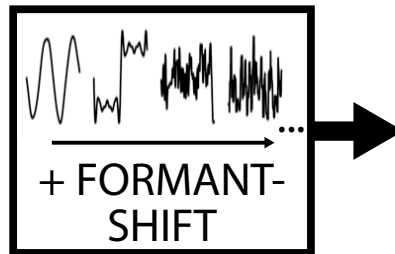

Clicking on the **wavetable name** will open a selection window. You can select and load a wavetable into the oscillator by another click on the mouse key ([please see screenshot on previous page](#)).

- **Wave:** Defines the playback position within the selected wavetable and thus determines its timbral character.
- **Formant:** Shifts the formants of the produced waveform and thus determines its timbral character.

Wavetable Drone

Here comes yet another and quite unique wavetable syntheses application: A cluster of four processed wavetables using the capabilities of a granular synthesizer. With just one parameter (**Jitter**) you can create a very wide sonic scope from „pure“ and „clean“ waveforms to harsh and complex noise. The resulting signals are quite useful as raw material for lush strings or choirs as well as for drum sounds and noise effects.

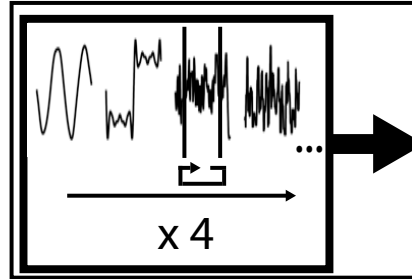

Clicking on the **wavetable name** will open a selection window. You can select and load a wavetable into the oscillator by another click on the mouse key ([please see screenshot on previous page](#)).

- **Wave:** Again, defines the playback position within the selected wavetable.
- **Jitter:** Controls the timbral character of the resulting signal. Turning the control counterclockwise will result in more tonal sound. Turning it clockwise, will provide increasingly harsh and noisy effects. Modulating this parameter can be very interesting.

Waveguide

Uses the wavetables discussed earlier and combines them with a resonator-algorithm. This results in percussive sounds that generally resemble plucked strings.

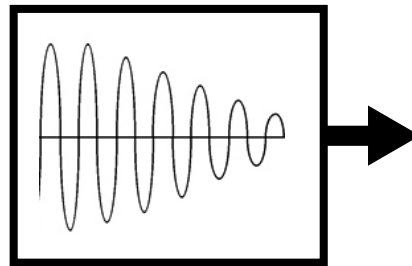

Clicking on the **wavetable name** will open a selection window. You can select and load a wavetable into the oscillator by another click on the mouse key ([please see screenshot on previous page](#)).

- **Wave:** Defines the playback position within the selected wavetable and thus alters its timbral character.
- **Color:** Increasingly damps the generated waveform, which corresponds to the acoustic properties of a plucked string.

Please note when modulating the Wave parameter: Modulation will only affect the first wave cycle that is stimulating the resonator. Modulating the Wave parameter while the previous sound is still resonating will have no audible effect.

MIXER

In this module, Factory's sound sources are combined and routed into the subsequent modules for further treatment. In addition, two of these signals can be **ring-modulated** with each other. The section also provides a **sub oscillator** and a **noise source**.

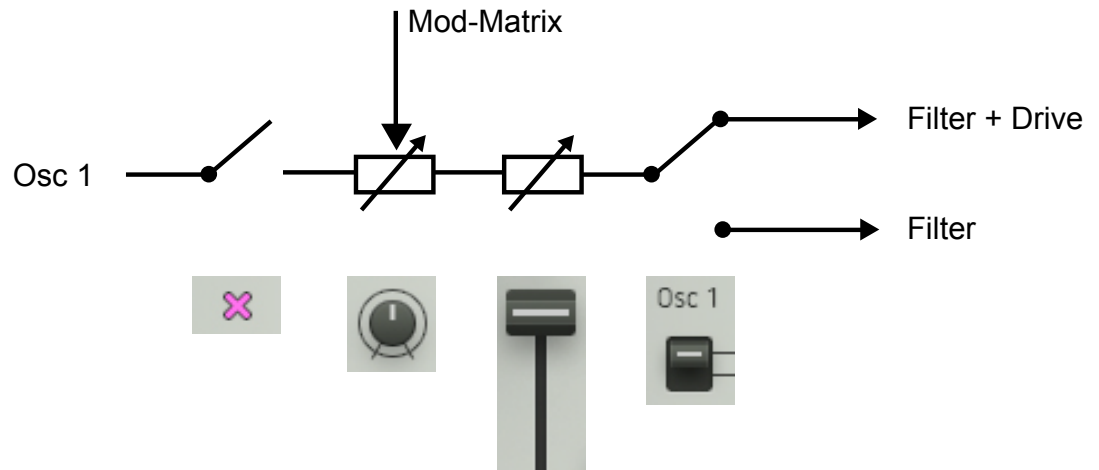
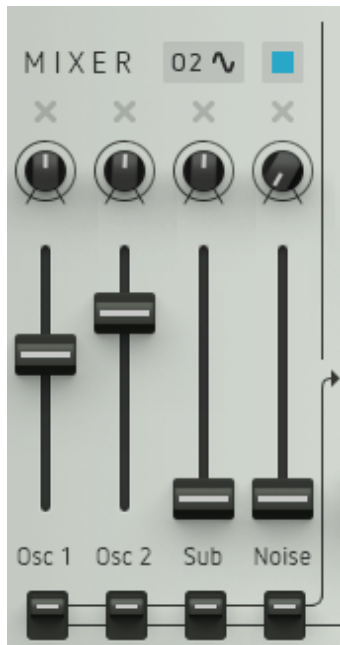

Why knobs AND faders? Operating principle of a channel strip:

On each mixer channel, you will find two daisy-chained level controls, a **knob** and a **fader** – why is that?

The knobs can be controlled via the modulation matrix (more about this later on). They are used for level *modulation*.

With the subsequent faders, you can control the level *ratios* between the different signals (according to the faders of a mixing desk).

An example: Let's suppose you want to create a drum pattern made up of kick and snare, using the internal sequencer. To generate individual hits, the sequencer's gate signals will open and close (modulate) two of the level knobs. To control the level ratios of these two sounds additionally, you are using the (unmodulated) faders.

Knobs and faders:

Osc 1/2: control the levels of both oscillator signals.

Sub: controls the level of the suboscillator signal. Its pitch is one octave below the master oscillator. Clicking on the **button** above the fader will make a window pop up where you can select several suboscillator sound sources:



- **O1 Sin:** a sinewave. Pitch follows oscillator 1.
- **O1 Sqr:** a squarewave. Pitch follows oscillator 1.
- **O2 Sin:** a sinewave. Pitch follows oscillator 2.
- **O2 Sqr:** a squarewave. Pitch follows oscillator 2.
- **Osc1xOsc2:** this setting will ringmodulate the signals of oscillator 1 and oscillator 2. The level of the ringmodulated signal is also controlled by the **Sub fader**. The timbral character of the ringmodulated signal depends greatly on the oscillator settings used and can be described as ranging from „singing“ to „metallic“.

Please note: when selected as a modulation destination, the suboscillator only gets a quantised modulation.

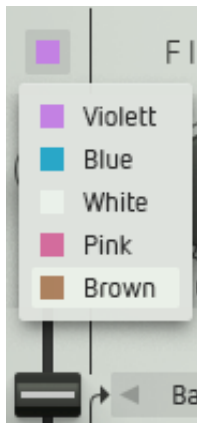

- **Noise:** sets the level of the noise signal. By clicking on the **Color symbol**, you can choose between five different noise types with different sonic characters.

Mute function:

Clicking on these **symbols** will mute the respective mixer signal input.

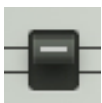
Routing switches:

These **switches** determine which signal is routed into the filter and drive sections (up) or just into the drive section (down).

Please note: Mute and routing functions cannot be assigned to a MIDI CC number (see MIDI CC assignment).

FILTER



As soon as the routing switches of the mixer are set to their upper position, the corresponding signal will be sent through the filter and the subsequent drive section. Factorys filter is a multimode filter with resonance and lots of sound-shaping potential.

By clicking on the dark shadowed **display**, a window will pop up. Here, you can select between eleven different filter types just by clicking.

You can also step through the filter types by using either **arrow buttons**.

The following filter models are available:



Filter models

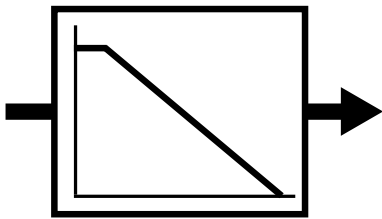

LP 2 Pole:

Lowpass with a 12dB slope. When the filter is closed (turning **Cutoff** counter-clockwise), high frequencies will be increasingly attenuated – the sound will grow more and more dull. **Reso** boosts the frequencies around the cutoff which will lead to a more and more pronounced sound up to self-oscillation.

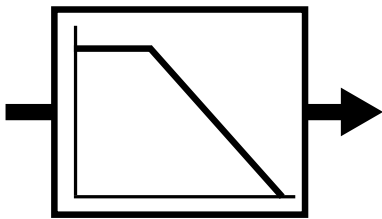

LP 4 Pole:

Lowpass with a 24dB slope. It is corresponding to the LP 2 Pole but with even more impact on the sound.

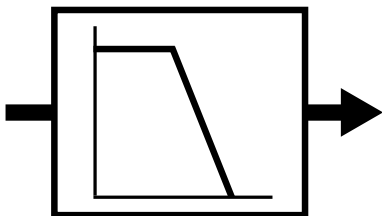

LP 8 Pole:

Lowpass with a 48dB slope. Another lowpass option with even ballsier results.

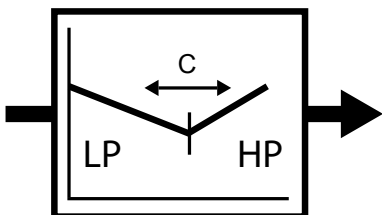

X Fade:

Blends between a lowpass and a highpass filter. When the **Cutoff** knob is at its central position, the filter will provide a neutral effect. By turning counter-clockwise, the filter will become a lowpass, by turning clockwise a highpass. In both cases, **Reso** boosts the frequencies around the cutoff/mid frequency which will lead to an increasingly sharper and more pronounced sound.

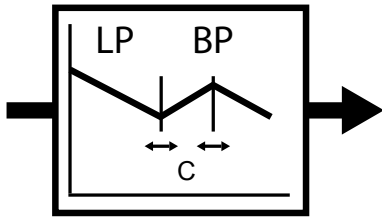
**Mid Boost:**

A combination of lowpass and bandpass, useful for boosting mid-frequency content of a signal. **Cutoff** controls cutoff resp. center frequency of the filters at a certain ratio. **Reso** boosts the frequencies around the cutoff/mid frequency which leads to an increasingly sharper and more pronounced sound.

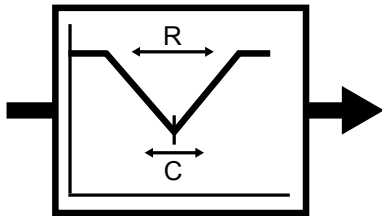
**Bandreject:**

Attenuates a specific frequency band. **Cutoff** controls its center frequency, **Reso** its width. Cutoff modulation results in phaser-like sounds.

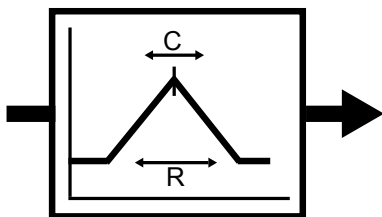
**Bandpass:**

Only a specific frequency band will be passed. Again, **Cutoff** controls its center frequency, **Reso** its width. Useful to thin out sounds around a specific frequency band.

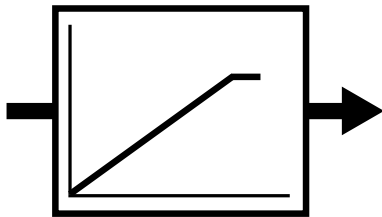
**Highpass:**

Highpass with a 12dB slope. When the **Cutoff** control is turned counter-clockwise, high frequencies will be increasingly passed through – the sound gradually becomes brighter. It works exactly the opposite way of a lowpass. **Reso** again boosts the frequencies around the cutoff frequency which will lead to an increasingly sharper and more pronounced sound.

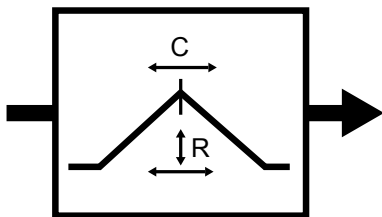
**Peak:**

Boosts a specific frequency range. **Cutoff** determines this range (its center frequency), **Reso** controls the amount of boost/attenuation. The higher the boost, the narrower the range boosted. This behaviour corresponds to a semi-parametric EQ which can be found with many mixing desks. The sonic result differs from the Mid Boost type.

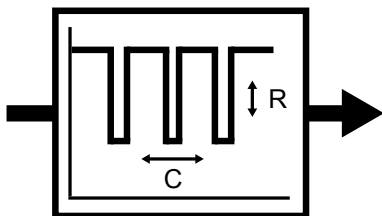
**Comb:**

Generates a so-called comb filter effect. It generates evenly spaced peaks and notches in the frequency band (quite similar to the teeth of a comb). **Cutoff** shifts their position, **Reso** determines the intensity of the effect. Cutoff modulation can result in flanger-type sounds.

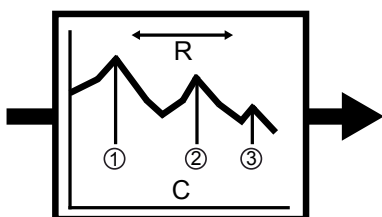
**Vowel:**

Generates vocal-like sounds by shifting certain formants of a signal. **Cutoff** selects three out of sixteen formants, **Reso** shifts them up/down. The zero-position of the reso control is at 12:00. Great in combination with e.g. vocal-like oscillator wavetables.

DRIVE



Drive provides a wide range of distortion effects from soft saturation up to heavy fuzz. In conjunction with the different filter models and their settings, Drive can generate very intense and dynamic sounds.

The **Drive** knob controls the intensity of the effect. Set fully counter-clockwise, the effect will be disabled (off).

When clicking on the dark shadowed display, a window will pop up. Here, you can select between three different **drive types** by another click (Tube, Diode, and Sine). They all sound very different.

Try using different routings and settings as the placement of a filter before a distortion in the signal chain can produce results which are significantly different from a signal that is routed into the fuzz directly.

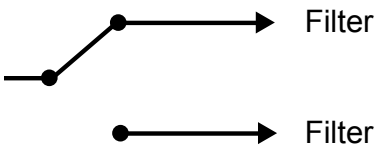

Filter + Drive

With the **routing switches** of the mixer in the low position, the signal is sent directly into the Drive section. In up position, the signal first passes the filter and is then sent to the Drive section (please refer to the [mixer section](#)).

Filter

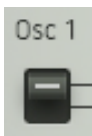

Sound Settings

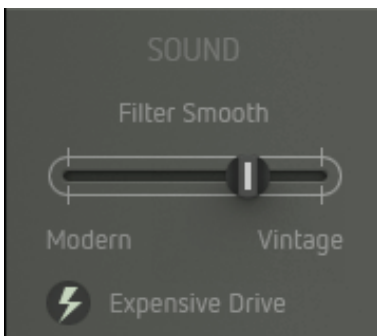

In the [Setting menu](#) you will find some parameters related to the sound of the filter and drive section.

Filter Smooth:

Here you can tailor the sound character of the filter section to your personal taste. The differences are quite subtle and best audible at high resonance settings.

Expensive Drive:

When enabled, Factorys Drive is even more enhanced by a four times higher resolution, making the drive sound absolutely free of audible artefacts. Needs somewhat more processing power.

OUTPUT

To the very right of Factory's panel, the output section is located. Here, you can control and modulate the overall output level (**Vol**) as well as the panorama position (**Pan**).

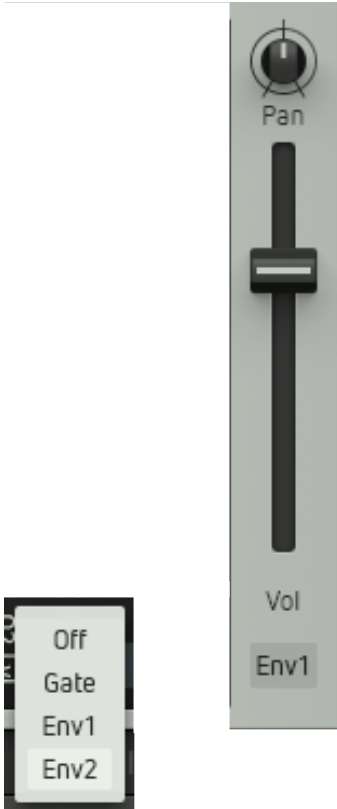

Volume modulation:

The output volume level is usually modulated by the volume envelope (ENV 1 – default setting).

By clicking on the dark shadowed display, you can select between four alternative types of volume level modulation:

- **Off:** No volume modulation. The sound will sustain infinitely at full level, even when there is no key played (resp. no MIDI note received). Useful for all styles of Dark Ambient Music – we call it the brick-on-keyboard generator.
- **Gate:** The sound will sustain at full level as long as a key is being depressed (resp. when a MIDI note-on command is received). The level will not be modulated. This is basically an organ envelope.
- **Env 1:** Envelope 1 modulates the volume level (default setting).
- **Env 2:** Envelope 2 modulates the volume level.

Pan:

Controls the position of the output signal within the stereo panorama.

This knob can be modulated via the [modulation matrix](#) which will generate an auto-panning effect. This is especially interesting with the polyphonic feature of the [LFOs \(please see below\)](#): Each voice can be shifted separately within the stereo panorama for some really head-spinning effects – without using psychotropic substances.

MODULATORS

Watch video

To bring its sound to life, Factory provides several modulation sources. The Modulators are of top priority. Click the tab labelled MODULATORS to open the respective window. You will find two identical envelopes (**ENV 1** and **ENV 2**), two **LFOs** that are also identical, and a **sample + hold** module.

With the exception of the default volume modulation (Env 1 → **Vol fader**), all modulation paths are created by using the modulation matrix. All modulators can be found there as modulation sources. The modulation matrix will be covered in the next chapter.



ENV 1 and ENV 2

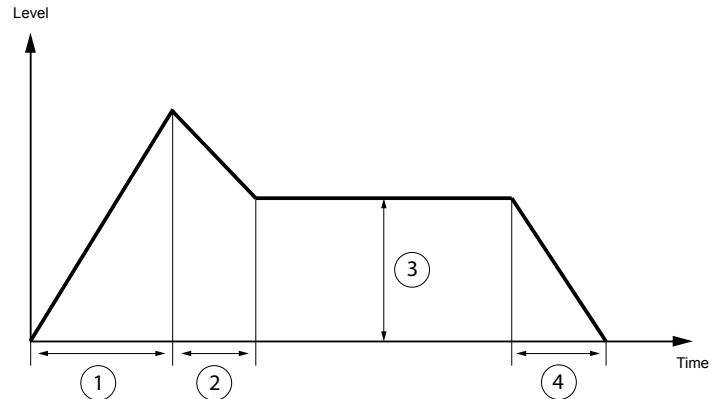
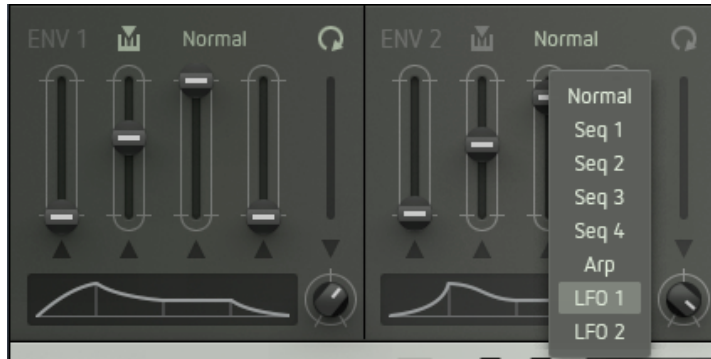

Envelope generators usually provide a one-off modulation. Shape and duration can be controlled by various parameters. Factory's envelope generators work exactly like this but provide a loop function to generate complex periodic modulation shapes with (did we hear anybody mention the name of that little British suitcase synthesizer). Both envelopes are identical.

Envelope shape:

The envelope shape is controlled by four faders:

- (1) The first fader (**Attack**) adjusts rise time from zero to maximum level.
- (2) The second fader (**Decay**) adjusts fall time from maximum level to Sustain level.
- (3) The third fader adjusts **Sustain** level. Its value is maintained as long as the envelope is receiving a MIDI note-on command, i. e. until the key is released.

- (4) The fourth fader (**Release**) adjusts fall time from Sustain level after receiving a note-off message.
- The **knob** alters the envelope shape in its entirety. You can watch the result in the **envelope display**.

Modulating envelope parameters:

The five parameters mentioned above can in turn be modulated as well. To do so, please select Env 1 or Env 2 as a modulation target in the [mod matrix \(more on this later\)](#). By clicking on the arrow symbols right beneath the envelope faders/knobs, you can determine which of these five parameters will be controlled via the mod matrix.



More envelope functions:

Loop:



The circular arrow symbol will loop the attack- and decay phase of the envelope. This produces periodic modulation shapes.

Velocity:



When clicking on the keyboard symbol, the maximum envelope level will be determined by velocity.

Trigger source:

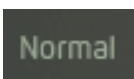

By clicking on this parameter, you can select the trigger source of the envelope. By doing so, the envelope will not only be triggered by a MIDI note-on command (default) but also by other events. This produces rhythmically accurate modulation.

Please select between the following options:

- **Standard:** The envelope will be triggered by the keyboard resp. a MIDI note-on command.
- **Seq 1 – 4:** The envelope will be triggered by the active steps of the selected sequencer track.
- **Arp:** The envelope will be triggered by the steps of the arpeggiator.
- **LFO 1 / 2:** The envelope will be triggered as soon as the respective LFO is entering a new wave cycle.

LFO 1 and LFO 2

The LFOs usually provide periodic modulation. A one-shot function is also present. That way, the LFOs can work as mini envelopes. Both LFOs are identical.



Rate controls the LFO speed in a range between 0.05 Hz and 500 Hz. When the **Clock symbol** is active, the LFO will be in sync with the song tempo. In this case, the Rate values will be translated into note values (eight whole notes to 1/32 note).

The lower right knob determines the **waveshape** according to the graphic display.

Phase shifts the phase angle of the LFO waveform. This function is especially useful in combination with retrigger (please see below).

Modulating LFO parameters:

The three parameters mentioned above can be modulated individually. To do so, please select LFO 1 or LFO 2 as a modulation target in the mod matrix (more on this later). By clicking the arrows beneath the faders/knobs, you can determine which of these three parameters will be controlled via the mod matrix.

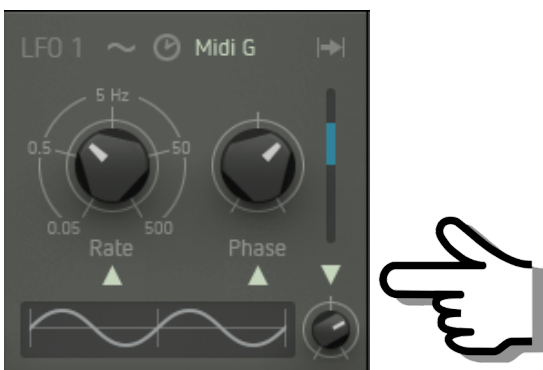

More LFO functions:

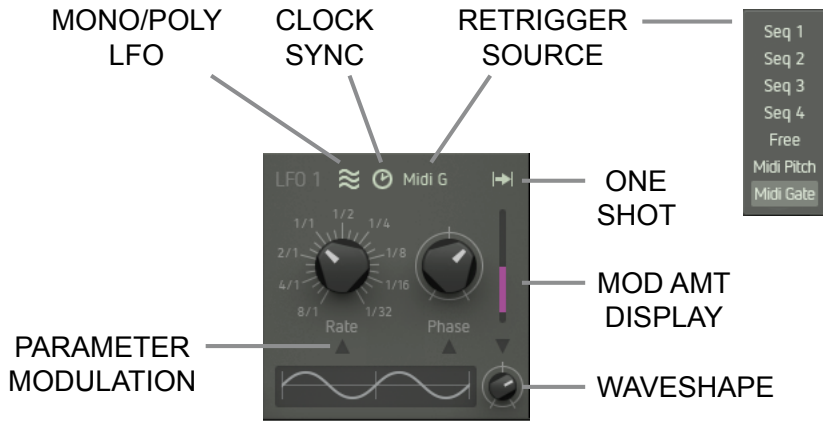

Retrigger:



By clicking on this display, you can select the retrigger source. Every retrigger will restart the LFO. This allows for rhythmically correct modulation that is perfectly in sync with the beat.

Please select between the following options:

- **Free:** No retriggering but the LFO will still be synced to the song tempo as long as the **Clock symbol** is enabled.
- **Seq 1 – 4:** The LFO will be retriggered by the active steps of the respective sequencer track.
- **MIDI Pitch:** The LFO will be restarted as soon as you are playing a new pitch. When you are repeatedly playing, say, a „G“ key three times, the LFO will not be retriggered. When you are playing e.g. a „D“ instead, the LFO will be retriggered.
- **MIDI Gate:** The LFO will be restarted with every new note played.

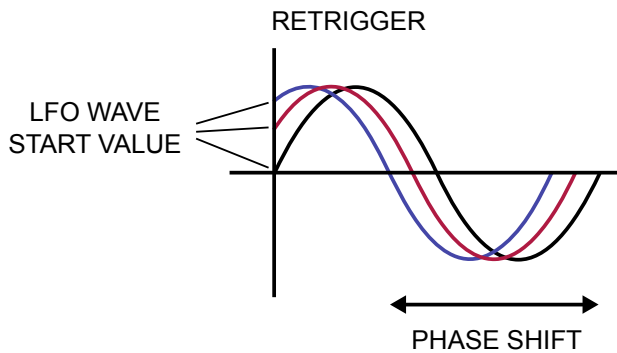

The retrigger function is very useful in combination with the phase parameter: By shifting the phase, the LFO will not start at zero crossing but with a certain amount of offset. In other words – the starting point of the LFO waveform can be defined and shifted back and forth which can be useful for extra-rich vibrato, complex modulation bursts etc.

One shot:



When the arrow symbol is active, the LFO will work in one-shot mode and stop after completing one full cycle. This function is especially useful with the retrigger and Phase parameters (please see above).

Mono/Poly LFO:



All voices will use the same LFO (Mono LFO).



Each voice will use its individual LFO (Poly LFO). This can result in more organic or more chaotic (i. e. life-like) sounds. It is also interesting in combination with the retrigger function. For drum and percussion sounds, it can be more useful to use the Mono LFO mode.

MIDI clock sync:



When active, the LFO will be in sync with the song tempo. In this case, the Rate values will be translated from „Hz“ into note values (eight whole notes to 1/32 note).

Sample + Hold

[Watch video](#)



Factory's sample + hold module is far more powerful and advanced than most S&H functions commonly implemented. By using Factory's sample + hold module you can create almost any kind of modulation waveshape – even rhythmically accurate and in sync with other modulation sources.

Function principle:

The module uses two signal inputs – one for the trigger signal that scans the input signal and another one for the signal source to be sampled. Both input sources can be selected by using a drop-down menu.

Every time the **trigger signal** exceeds the **threshold** level, an **impulse** will be generated. This impulse will measure (scan) the current value of the **sample source signal** level which is held until the next trigger comes in, again sampling the current value and holding etc. (“sample” and “hold”, geddit?). This will produce a stepped waveform („**resulting signal**“).

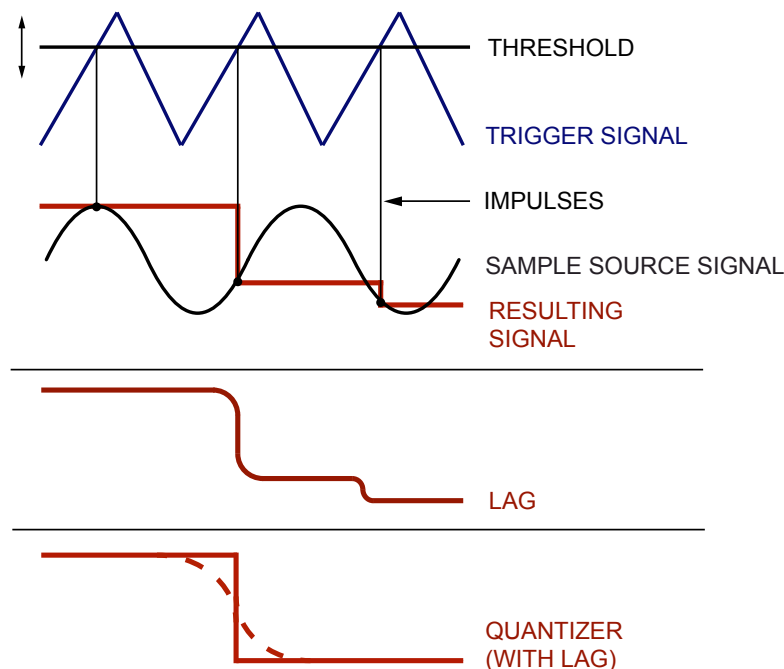

The example shows the basic function principle with very simple input waveforms used. Even here you can see how complex the resulting waveform might eventually become by simply altering the threshold setting and the frequencies of scan pulse and sampled signal. Triangle and sinewave can be replaced by audiosignals if so desired. You might also want to use more complex LFO waveforms, or how about running the sequencer outputs into it? The resulting waveform will become more and more complex, odd, and interesting. Since the results will not always be totally predictable, we – as the manufacturer of your choice – advise you to indulge yourself unlimited experimentation, restricted only by your imagination. When using clocked input signals ([sequencer](#), synced [LFOs](#), or [envelopes](#)), you will get rhythmic modulation effects.

Functions / controls:

Here you will find all functions of the S + H module:

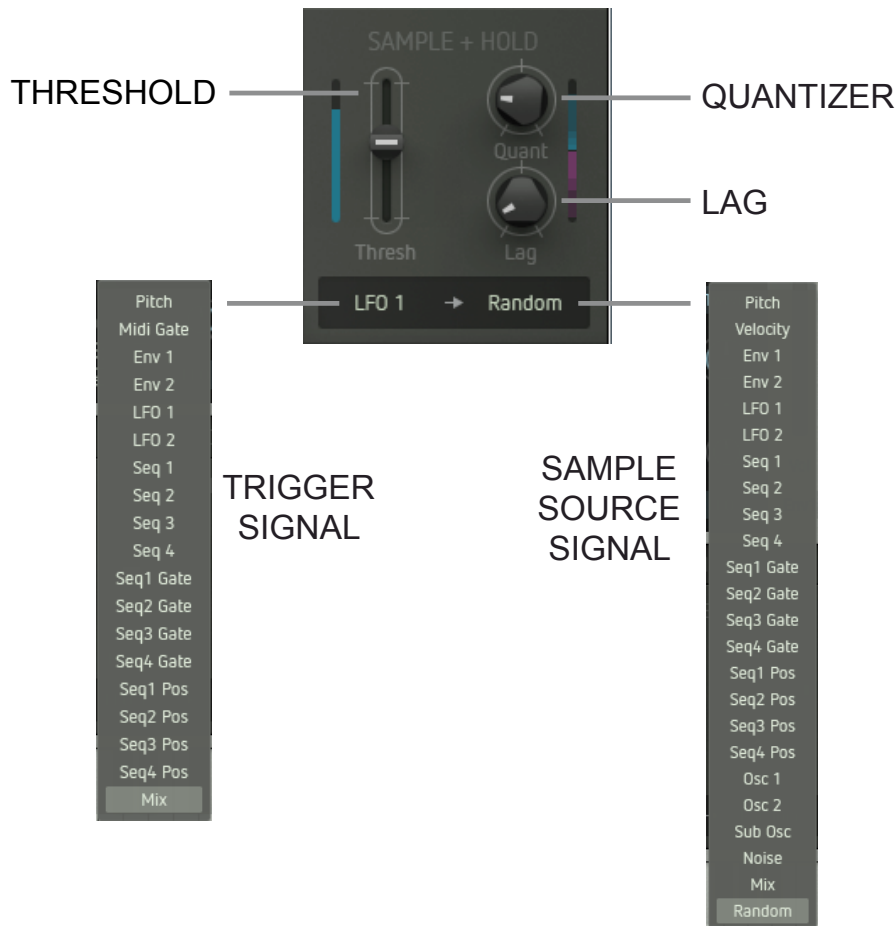

- **Input signals:** Click to select a **trigger signal** (left) and a **sample source signal** (right).
- **Tresh:** Sets the **trigger threshold level**.
- **Lag:** Increasingly smoothes the edges of the resulting waveform.
- **Quant:** Quantizes the resulting waveform. The waveform will become increasingly coarse and more and more stepped. Lag and Quant can be used in conjunction in order to shape the wave depending on the setting of these parameter (please see example on [previous page](#)).

MODULATION MATRIX

Function principle:

[Watch video](#)

The modulation matrix is Factory’s central key element. It is used to set up modulation paths in a very easy and flexible manner. It provides you with the patching flexibility and timbral power of a really big modular synthesizer – of course fully storable in memory, and polyphonic at that!

Using Factory’s modulation matrix, you can patch up to eight modulation paths at a time. That should be enough for the majority of really far-out sounds.

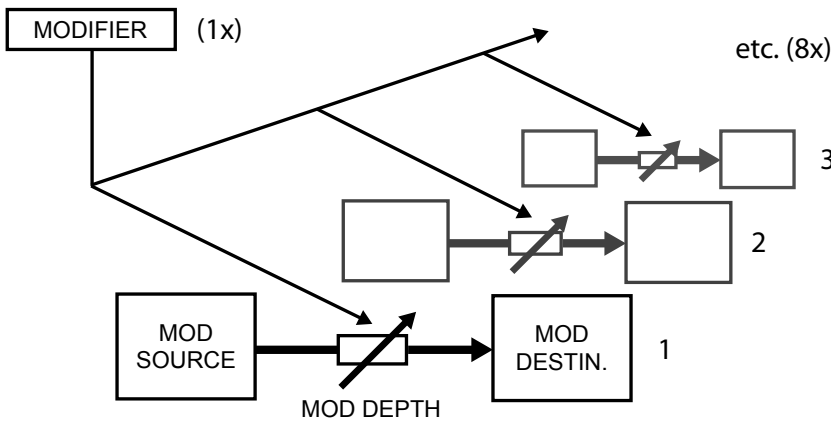

A modulation path consists of a **source** and a **destination** parameter which is modulated at a specific level. The intensity – or **modulation depth** – can be manually controlled for each modulation path individually. An arbitrary **modifier** provides the global control and/or modulation of all modulation depths as well.

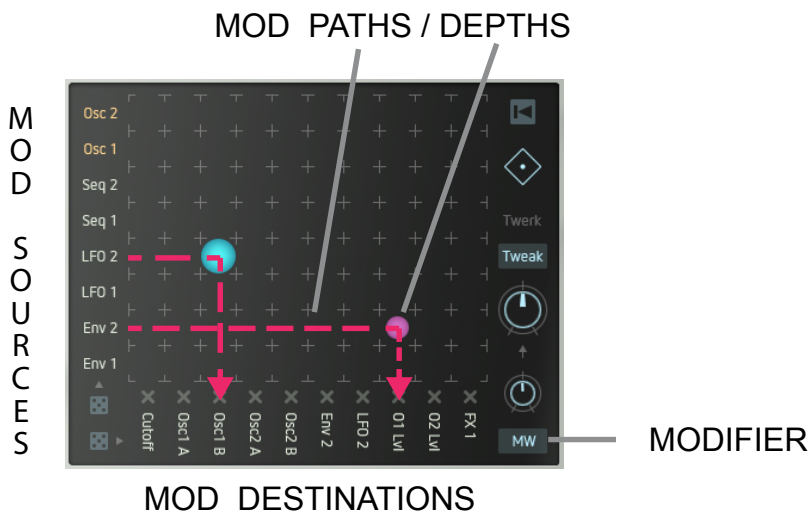

Since Factory is a polyphonic synthesizer from a technical point of view, each voice uses its own complete modulation matrix. Their parameter settings are of course identical (you define them on the user interface) but in the background, all active voices will be processed separately. The technical effort takes quite a bit of calculating work, and we are glad that Factory is not all too wasteful with the resources of your computer, though.

Using Factory's modulation matrix:

Select modulation sources:

Modulation sources are arranged vertically. As soon as you click on an item, a small menu will pop up (please see below) and show all sources available for this slot. A click on the desired item will allocate the source to the matrix.

The selection is the same for all slots, except 1 and 2 (labelled in orange): These additionally provide audio signals as modulation sources (output signals of oscillators 1 and 2, suboscillator and noise generator as well as the summed-up output signal of the mixer). These signal paths are processed in extra high resolution to ensure an extraordinarily high sound quality.



Most of the terminology used for the sources will speak for itself. Only the sources provided by the sequencer may require a brief introduction:

- **Sequencer 1 to Sequencer 4:** transmit the parameter values of the active sequencer steps, allocated to the respective sequencer track.
- **Seq 1 Position to Seq 4 Position:** the respective sequencer track transmits a value according to each step position (1 to 16). Depending on the playback direction of the sequencer, this setting creates a counter going upward or downward respectively.

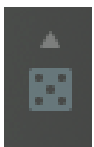

Clicking on the **dice symbol** right underneath the sources will allocate a **random selection of modulation sources** to the matrix. Even though the results may differ from a standard synthesizer patch quite a bit, we are sure you will be a winner in most cases. At least, these random settings can be a springboard for exploring uncharted timbral territories.

Select modulation destinations:

Modulation destinations are arranged horizontally. Here, too, clicking on an item will open up a drop-down menu that displays all destinations available for this slot. A click on the desired item will allocate the destination to the matrix. The selection is the same for all slots without exceptions.

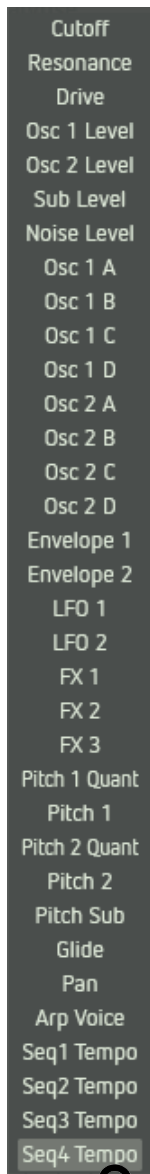

Some of the labellings are self-explanatory, others are explained here:

- **Osc 1/2 A - D:** Up to four knobs to control the oscillator models.
- **Envelope 1/2:** Selects an envelope module as a mod destination. Select the desired parameter directly in the envelope window (click **arrow** symbol).
- **LFO 1/2:** Selects an LFO module as a mod destination. Select the desired parameter directly in the LFO window (click **arrow** symbol).
- **FX 1 – 3:** Selects an effect slot as a mod destination. Select the desired effect parameter directly in the effect slot (click **arrow** symbol).
- **Pitch 1/2 Quant:** Oscillator pitch. The modulation is quantized in semitones. A continuous mod source (e.g. LFO sinewave) will generate pitched sequences that resemble little tunes.
- **Pitch 1/2:** Oscillator pitch – no quantization. Continuous pitch alterations will be generated this way (e.g. beat frequencies, pitch sweeps).
- **Pitch Sub:** Suboscillator pitch. Normally, the suboscillator follows the pitch of its master oscillator, quantized in semitones. To modulate the suboscillators pitch independently from its master oscillator, please use this setting as modulation destination. **Please note that this modulation is also quantised.**
- **Arp Voice:** This one is for the voice/note allocation of the arpeggiator. This way, the order in which notes will be played back can be controlled/modulated by a modulation source.
- **Seq 1 – 4 Tempo:** Modulates the tempo of a selected sequencer track. The tempo changes are quantized to note values in order to keep timing intact.



Clicking on the lower **dice** will allocate a **random selection of modulation destinations** to the matrix. Take a gamble.

Mod path mute:

Clicking on a purple-colored „X“ will mute the corresponding modulation path. This function is quite useful if you wish to tidy up the matrix temporarily or to isolate single modulation paths within a complex setting and check their respective effect on the sound or patch.

Create modulation connections / define modulation depth:

To connect a source to a destination, simply place your mouse at their point of intersection in the matrix grid and move the mouse up or down while keeping the mouse button depressed. This will create a coloured circle at the intersection. The size of the circle symbolizes the modulation depth. Blue means a positive value, purple a negative value.

A double-click on the circle will reset the modulation depth to zero resp. disable the modulation path.

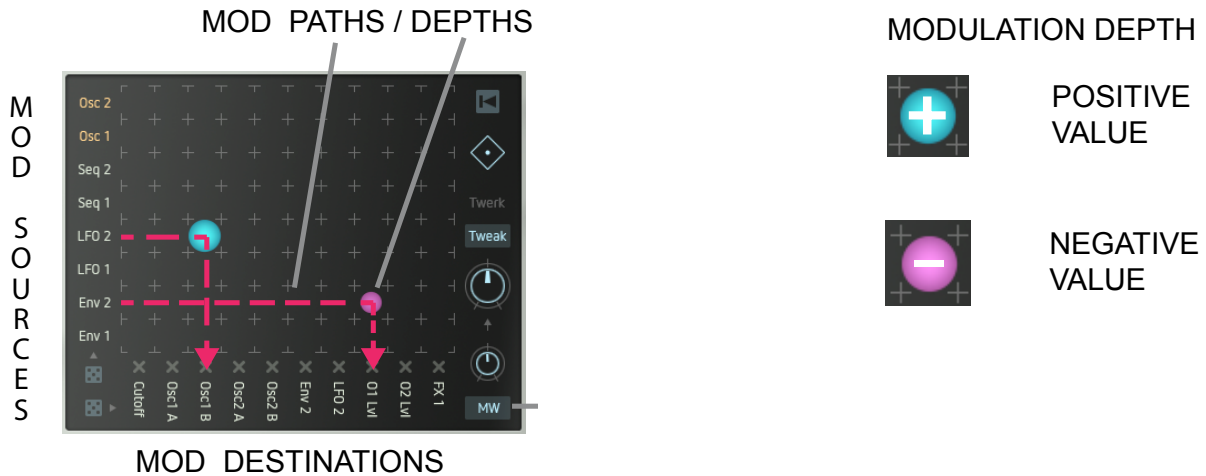

Modulation depth and direction is also displayed by colored bars or rings respectively, visible on the control of the destination parameter. This allows you to see at a glance which source modulates which destination at what depth.

The following figure explains the relation between a parameter value (here cutoff) and modulation depth. The parameter value defines the position of the modulation range. The amount of the modulation depth defines the width of the modulation range. Sounds weird, we know, but just toy around with it and you will see.

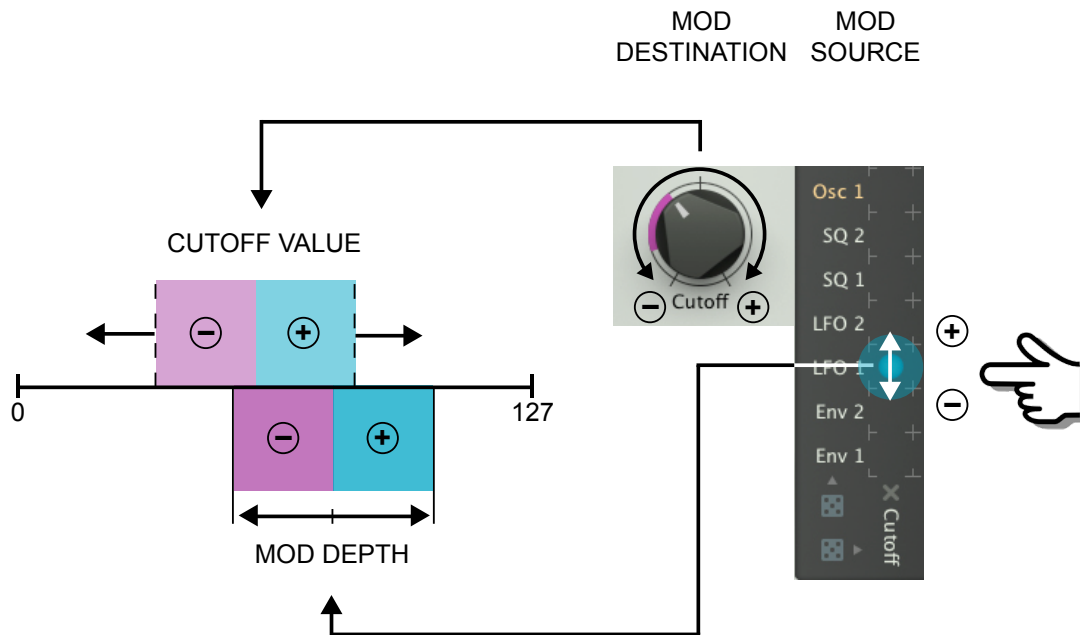

Reset the matrix / delete all modulation paths:

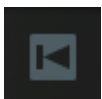

To delete all previously made modulation paths, simply click the rewind symbol in the upper right corner.

The modifier or matrix modulation: [\(Watch video\)](#)

Now it is about time to introduce you to another layer of complexity inherent to the modulation path. Picture this: You want to fade in and out a timbre variation (LFO 1 → Cutoff), using the mod wheel.

First, initialize the matrix by clicking on the **rewind** symbol. Then proceed like this:

1a. Create a modulation path by defining a source (LFO 1), a destination (Cutoff) and a positive modulation depth (a blue circle at the intersection point). Now, a cutoff modulation should be audible (something like “wah-wah-wah” or “boink-boink-boink”, depending on the waveshape used for modulation... you get an idea).

1b. Decrease the modulation depth by reducing the circle width until the filter modulation becomes almost inaudible. This setting defines the minimal value of the modulation depth. It will be reached when the modwheel is fully turned down.

But now, please turn up the **modwheel** fully.

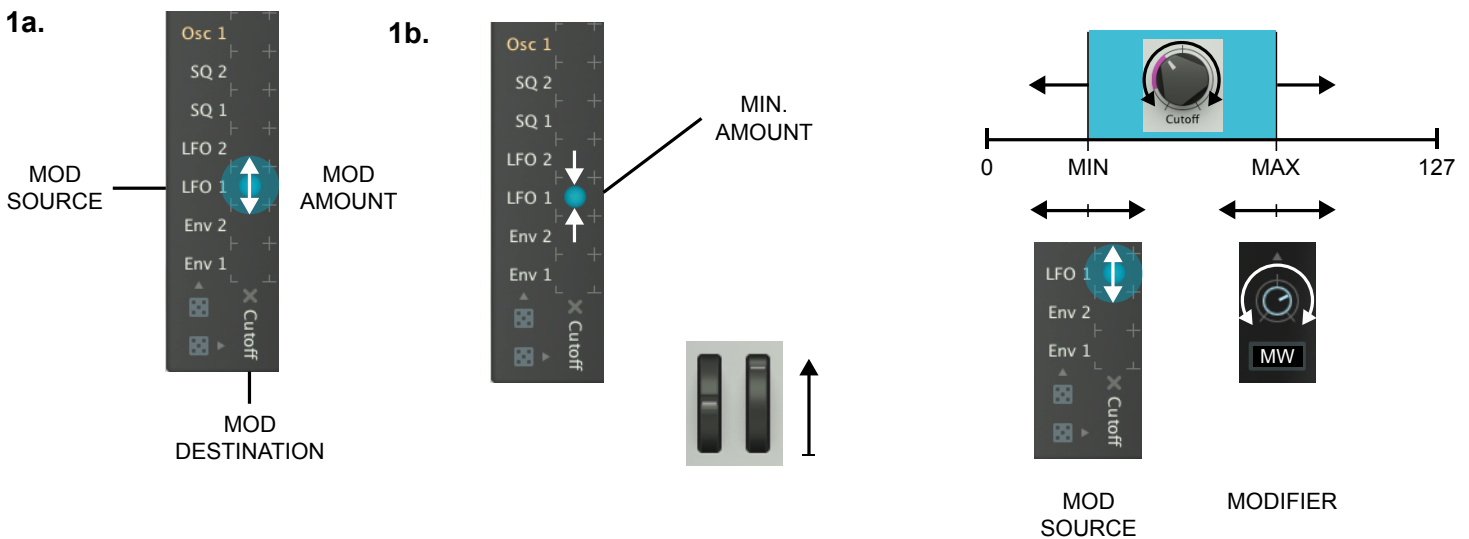

2. Select the setting „Target“ from the upper popup menu. Then select the **modifier** (here MW – modwheel) using the lower pop-up menu and turn up the intensity knob fully. In the matrix, a second (blue) circle with variable size will appear. This setting defines the maximum value of the modulation depth. It will be reached when the modwheel has been turned up fully.

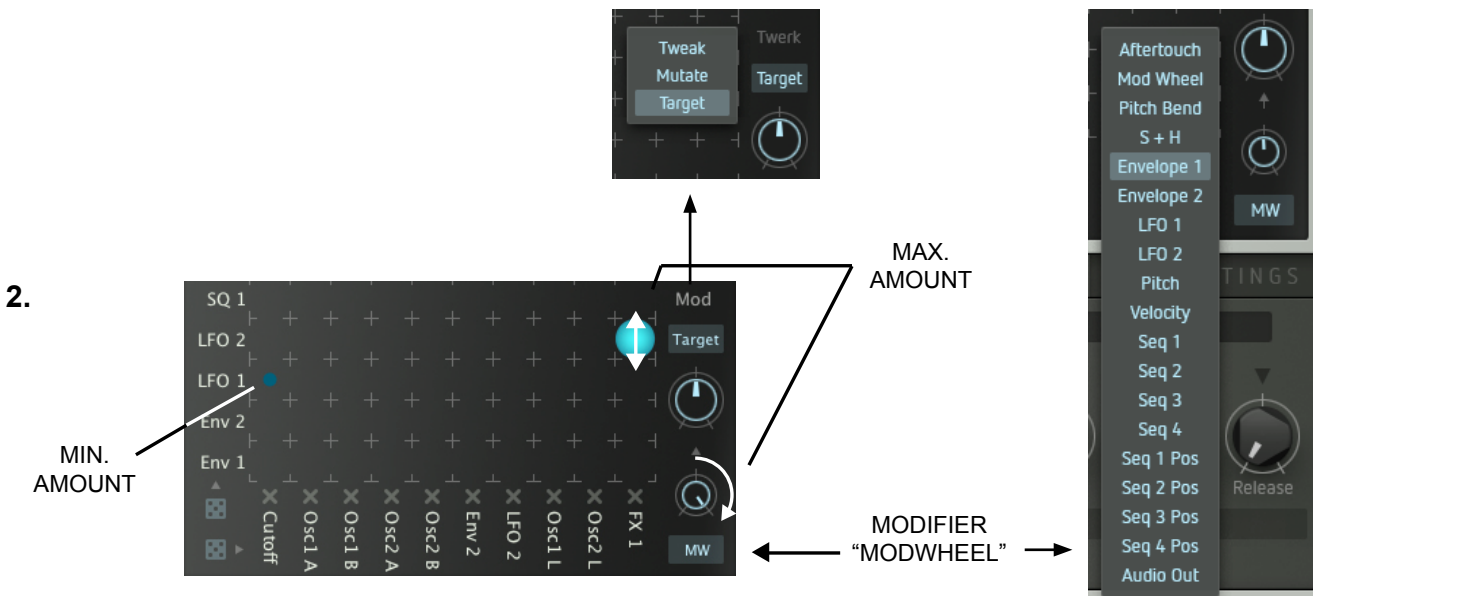

3. Turn the **Target** knob slowly. By doing so, you can shift the new circle to the modulation path previously created (circle at the intersection point between LFO 1 and Cutoff). Minimum and maximum modulation depths will be combined automatically. Now turn the **modwheel** back and forth – the modulation depth will change within the previously defined range. By turning the Cutoff control, you can shift the position of this range. The movement of the coloured ring around the cutoff control exactly shows the resulting modulation depth/ range.

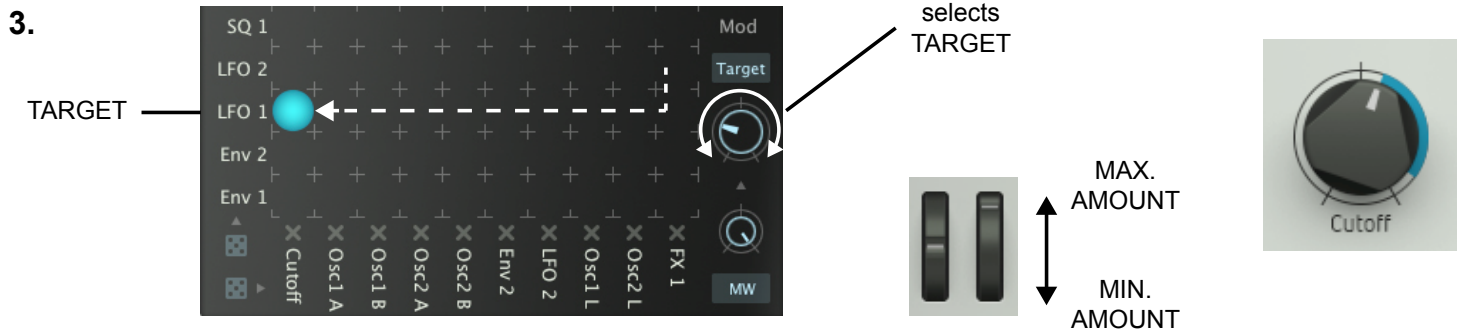

The following figure will make the relationship between the different parameters and their value settings easily understandable.

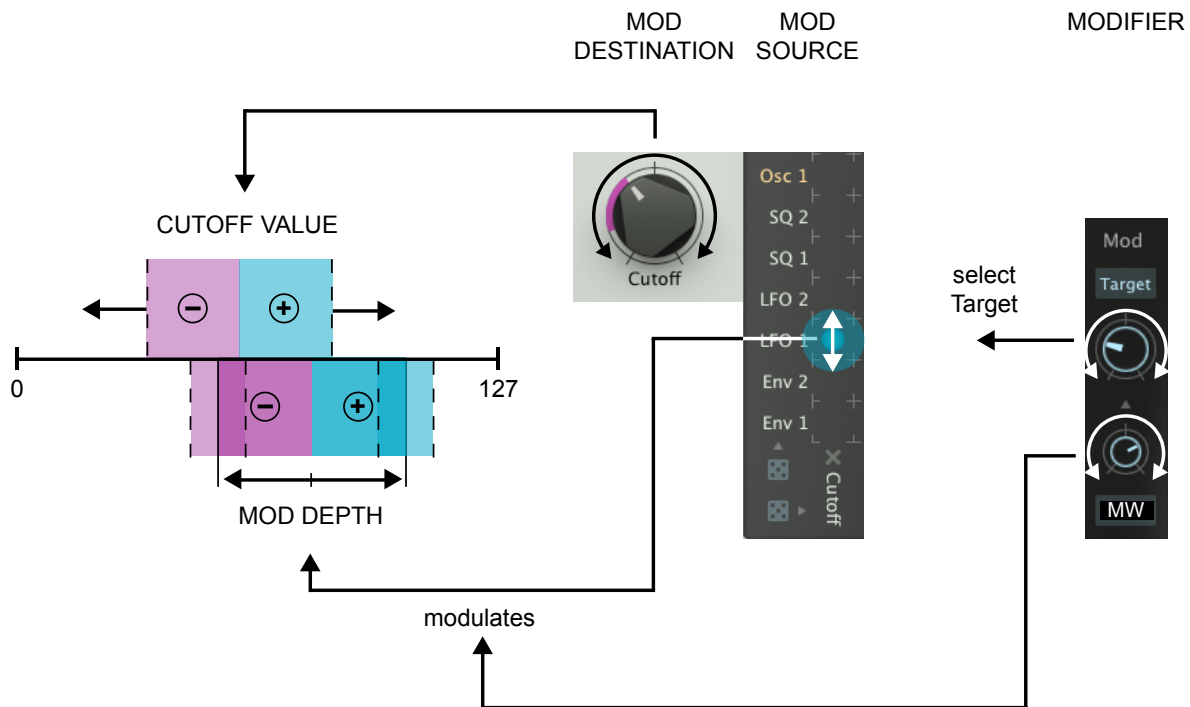

Please note:

To keep things simple, we limited our example to positive modulation depths. Of course, all these values work in a bi-polar fashion. You can alter the example e.g. by using a negative modulation depth for the target. That way, the timbre variation would be increased by turning down the modwheel and vice versa.

You can adress *one* modifier at a time, e.g. mod wheel for the entire matrix.

Please note:

To make sure that a circle appears in the mod matrix when setting a modifier, the corresponding modifier has to put out a positive or negative value with an amount other than zero (the example below shows LFO 1).

When e.g. the modwheel is fully turned down (no output), the circle will be minimized resp. invisible. This is also why we asked you to turn up the modwheel in step **1b**.

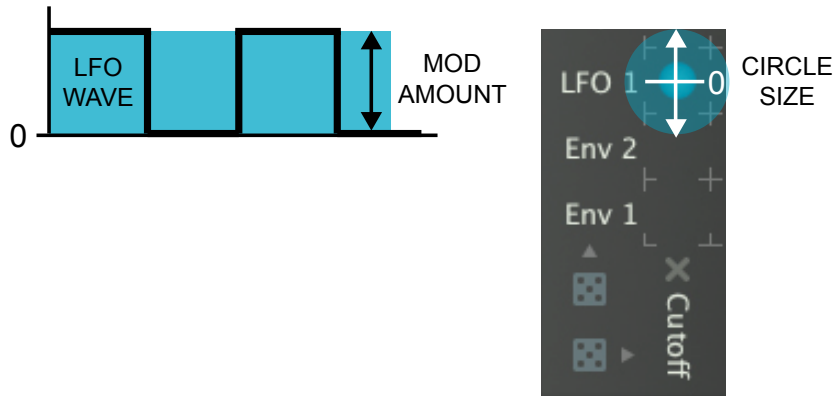
**Mod Tweak and Mutate functions**

In the section above, you have modulated the modulation depth of *one* modulation path with a modifier (e.g. modwheel). But there is more: The matrix provides an interesting function that enables the chosen modifier to alter the modulation depths of *all* active mod paths at a time. The ratio between the amounts will be retained.

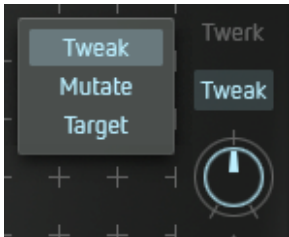
Mod Tweak:

Load an appropriate preset with many mod paths (e.g. „Choirbeast“). Set the **Mod** parameter to **Tweak**. Turn the **knob below** the selection window to alter all modulation depths manually.



Check, if „LFO 2“ is chosen as modifier. Turn the **knob above** the modifier and watch the pulsing circles in the matrix – nice, eh? This will wipe the floor with most arcade games.

Now all modulation depths are changing simultaneously by the selected modifier (here LFO 2) – in accordance with their original ratios. When a value is exceeding its available maximum range, it will be „mirrored“.

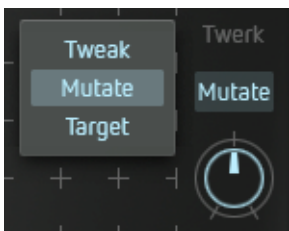
Mod Mutate:

This function works in a very similar fashion to Mod Tweak but it varies the modulation depths randomly – still in accordance with their original ratios.

By returning the knob to its original position, the initial values will be retrieved, including all stages in between. View it as a random function with undo-option, if you wish. Probably unique in the known universe, and so incredibly useful (at least sometimes).

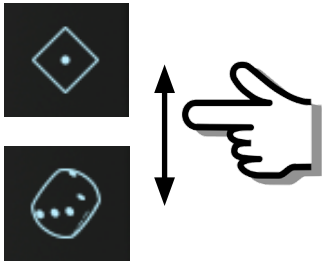
Random function (dice symbol on end):

This function automatically creates new modulation paths. Keep the mouse button pressed and drag the mouse vertically across the dice symbol. The matrix will be increasingly randomised.

Again, this is the trick: By moving the mouse backwards, the initial state of the matrix will be completely recreated, including all in-between stages. By moving the cursor again, exactly the same process will be repeated. By moving the cursor up and down (resp. „rolling the dice“) you can control an unlimited undo/redo function that will cover all the settings / parameters of the matrix.

The matrix will be initialised and the settings / mod paths previously active are deleted only after clicking on the backwards symbol (top right). When you are now rolling the dice again, a completely new configuration of the matrix will be generated.

Since the results are reproducible, the practical use of this system is much higher than a conventional „random“-function.

All settings that have been generated by the Mod Tweak, Mutate, and Random functions will be stored in a preset, along with all other patch data.

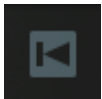
Initializing the matrix:

Simply click on the **backwards** symbol to erase all existing modulation paths (please see also „random function“).

The mod depth of single modulation paths can be set to zero resp. disabled by double-clicking on the desired circle in the matrix.

SEQUENCER

Watch video

Factory features an internal step sequencer with four tracks of up to 16 steps each. It can control pitch and – via the mod matrix – lots of sound parameters (35 parameters, to be exact...).

The sequencer window will always display one of the four tracks. All functions (except Global Swing) can be edited individually for each track.

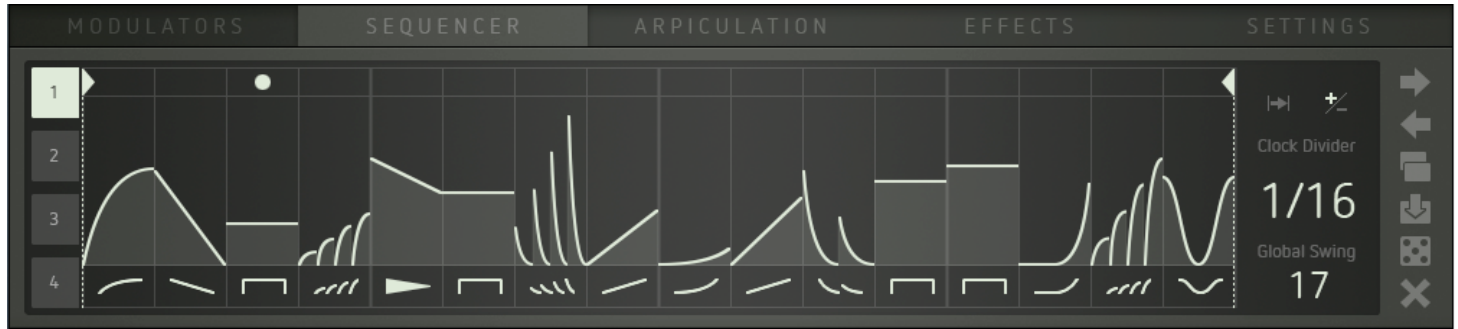

When Factory is running in stand-alone mode or as plug-in with internal clock source, the sequencer will start playing when receiving a note-on command (press **key on the keyboard** to verify).

In plug-in mode using an external clock, Factory's sequencer will be controlled by the start/stop commands of the host sequencer.

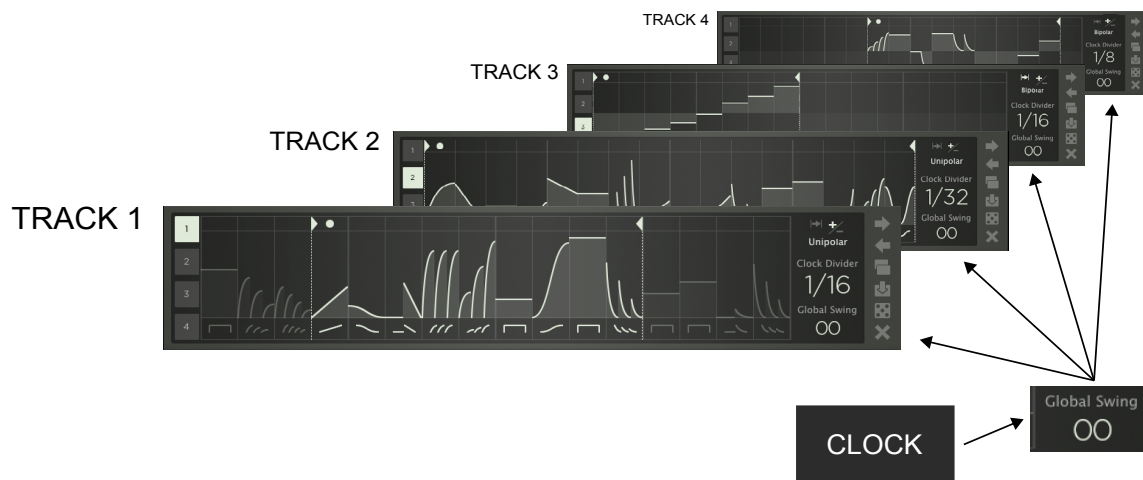

Drawing parameter values / using Step envelopes

You can draw pitches resp. parameter values directly into the track window. You can select one out of 36 step envelopes per step. These will provide different envelope shapes as well as multi-triggers with steady, increasing, or decreasing levels/velocity. This will make programming pretty complex and interesting sequences as easy as eating cake (German saying... Germans love cake, among other things). It is also fairly easy to create the illusion of a sequence that contains more than 16 steps: Using e.g. step envelopes with double triggers and running the sequence at half speed will create the illusion of a sequence that is made up of 32 steps.

When using the quantized oscillator inputs (OSC1/2 Pitch Quantized) as mod destinations, ramp-shaped step envelopes will generate note sequences. Their harmonics will depend on the setting of the scale parameter in the Pitch Factory window.

The swing function (Global Swing)

It is used to shift the offbeat steps of all tracks by the same factor. This is a global parameter. The multi-triggers are also affected by the swing function.

We advise to try out the sequencer using a slow tempo first.

Track parameters and functions

The following figure shows all the available track parameters and functions:

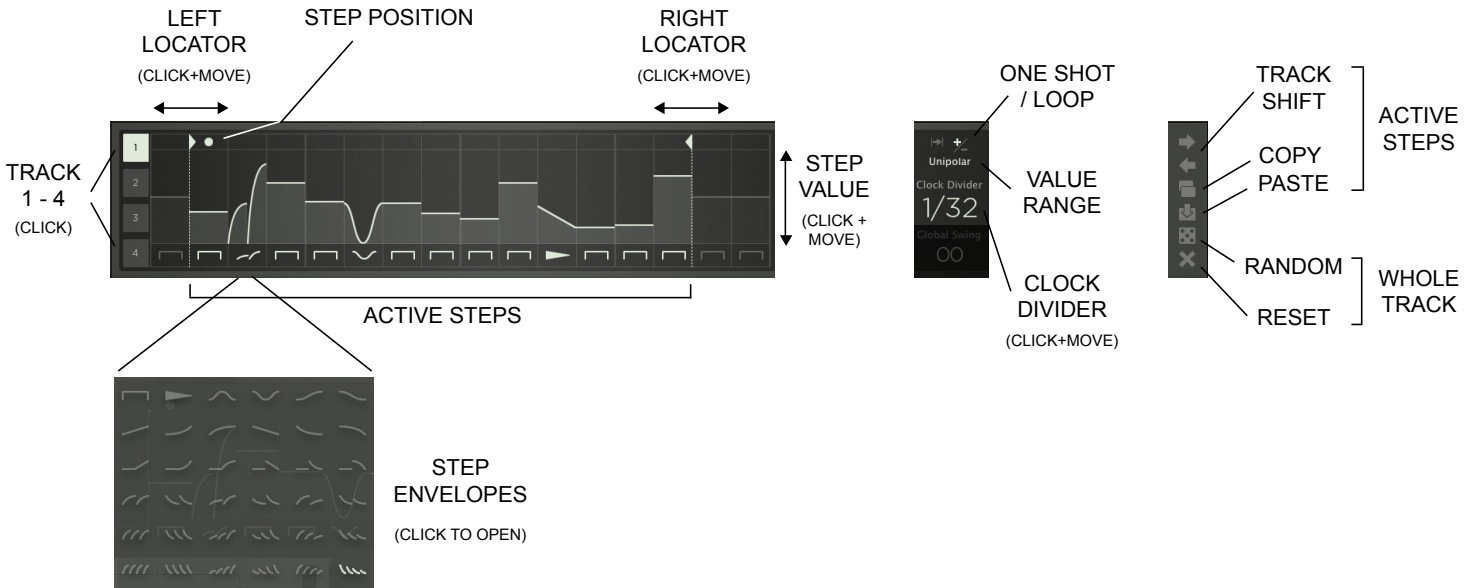

Select a **track** by clicking on its number button.



By shifting the left and right **locator** bars, you can define the range of the track that will be played back. Each track can have its individual playback range.



Click on the lower field of any step to open a drop-down menu containing the available **step envelopes**. Select the desired envelope(s) for each step.



Draw **parameter values** for each step using the mouse. Per track, you can select between unipolar (positive values) or bi-polar (positive and negative values) step parameter ranges.



Each track can run as a continuous **loop** or in **one-shot** mode.

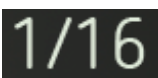

Click and drag the mouse up/down to select a clock divider that determines the clock setting resp. **tempo** ratio between the individual tracks.



Track Shift will move the range between the locator bars back and forth stepwise.



Clicking on the dice symbol will create a **random** selection of step envelopes and values for all steps of the current track.



Clicking on the X-symbol will **initialize** the current track, i.e. all steps will be returned to their default settings/values.



Copy will copy the range between the locator bars (now, would you believe...?).



Paste will insert the copied range between the locator bars. This can be used for the same track or for a different one.

When the inserted range is smaller than the newly defined range, the inserted range will be multiplied accordingly. When the inserted range happens to be larger than the newly defined range, the redundant steps will not be inserted.

COPY STEPS 9 - 13

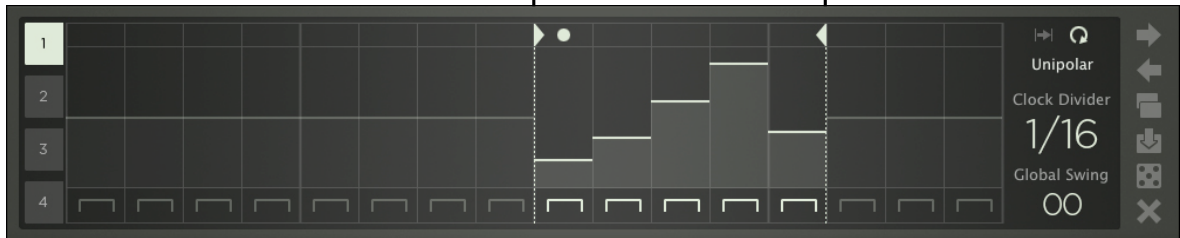

PASTE TO STEPS 1 - 13

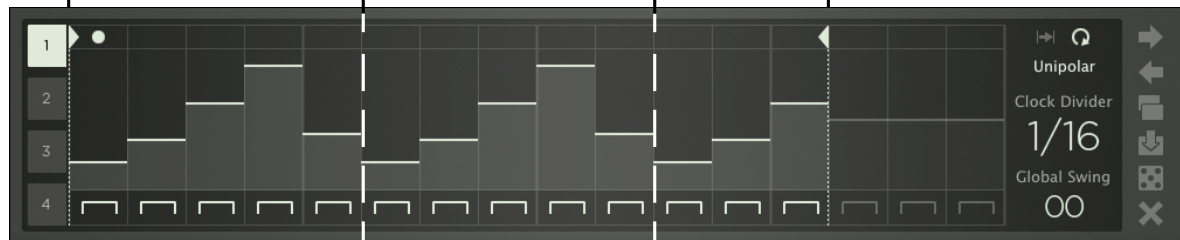

PASTE TO STEPS 1 - 4

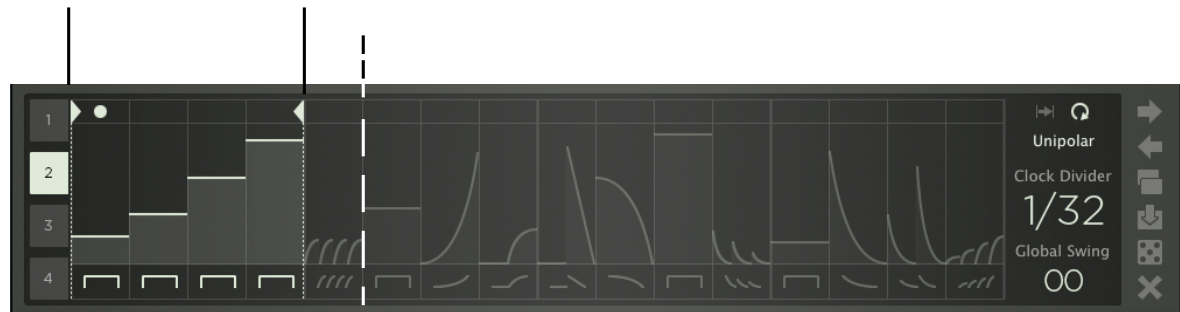

ARPICULATION

Watch video

This section provides an arpeggiator, several functions to control pitch with (Pitch Factory) as well as some parameters that produce a certain „animation“ or „vintage feel“ (... if this were a tape recorder, some would call it “wow and flutter”).

Pitch Factory



Here you will find global functions related to pitch and polyphony.

Tune:

Changes the global pitch cent-wise between 0 and +/-99 cent.

Transpose:

Changes the global pitch by semitones between 0 and +/-36 semitones (3 octaves).



Quantize:

Using the „**Scale**“ drop-down window, this will select one out of twelve musical scalings. The „**Quantize**“ knob above is used to select the desired root note („C“ – „B“).

This function determines the scaling of the quantized oscillator inputs (Pitch 1/2 Quant). In combination with sequencer, arpeggiator or LFOs as modulation sources, note sequences with perfect pitch will be generated. No more odd or bum notes – unless you feel so inclined.

Glide:

Time determines the duration of the glide-effect.



Clicking on the **staircase** symbol will create a glissando (stepped) instead of a portamento (smooth) transition.



When the **hand** symbol is active, the glide effect will be noticeable only when playing legato, i. e. not lifting your fingers between two key depressions.

Bender:

Selects the intensity of the pitch bender individually for up/down movement by semitones (zero to 36 semitones / three octaves).

Unisono:

Enables unison mode (voices will be stacked onto one single note for ultra-rich overkill sounds to melt worlds with... something along these lines, you know). By moving up the fader, the voices will be increasingly detuned against each other.

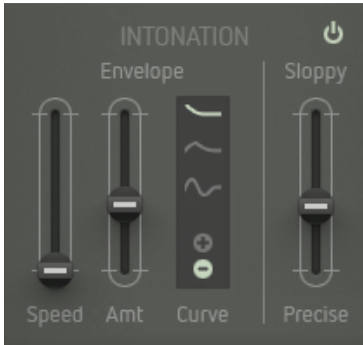
Intonation

These parameters sport a simple mini-envelope that will start with the note-on command coming in. It controls pitch and Factorys intonation. Low values can create subtle inaccuracies that may result in a more „life-like“ or authentic tone you would also find with acoustic instruments or all synthesizers named “vintage” (or in need of a service). High values will produce pitch-changes just like a sitar or slide guitar – instant Ravi or Stevie Ray.

On/Off:

This button will enable the Intonation parameters.

Curve:

Selects between three different envelope shapes and positive resp. negative modulation depth.

Speed:

Determines the duration of the envelope.

Amt:

Controls the intensity of the effect.

Sloppy/Precise:

Creates a pitch imprecision at the beginning of a played note.

Arpeggiator

The arpeggiator breaks down the notes of a chord into a rising or falling sequence of pitches. Enable / disable the arpeggiator using the **on/off** button.

Clock Source:

This determines the clock source that drives the arpeggiator and controls its speed. You will find the following options:

- **Counter:** Factorys internal clock source.
- **Spawn:** By leaving out clock pulses, a „stuttering effect“ is generated but the arpeggiator will still remain in sync with the clock source.
- **Seq Gate 1 – 4:** The gate signals of the sequencer tracks shift on the arpeggiator. It is synced to the sequencer.

Clock:

Click and drag the mouse up/down to select a clock divider that determines the tempo.

Voice Select:

This function determines the order in which the voices are played back resp. the note order.

- **Cntr (Counter):** The voices/notes are played back in subsequent order. The direction depends on setting of the Direction parameter.
- **Rnd (Random):** The voice/note allocation is controlled randomly. A random sequence will be created that way.
- **Matrix:** The voice/note allocation is controlled by a modulation source through the mod matrix. Select Arp Voice as modulation destination in the matrix. This way, the note order can be controlled/modulated in various ways.

Direction:

Determines the running direction resp. the melody pattern that is played by the arpeggiator within one octave. The following figures explain the scheme:

(Settings: **Voice Select „Cntr“; Octave Range „2“**):

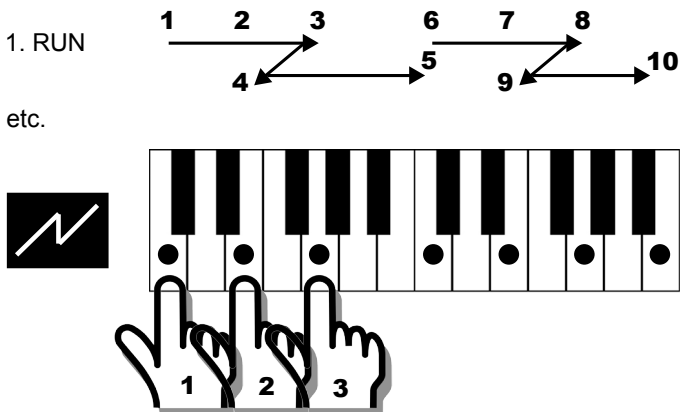
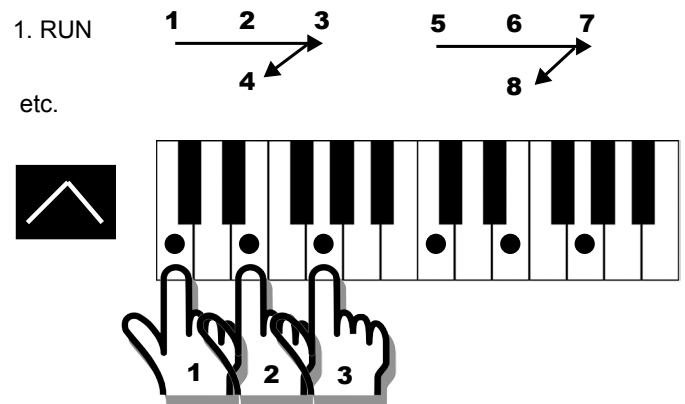
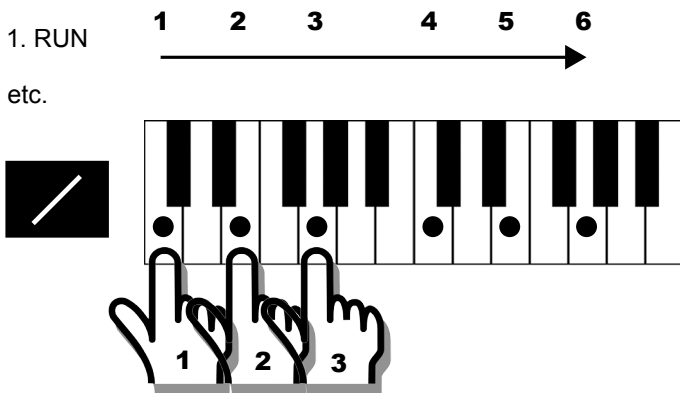

Octave Range:

This function determines the number of octaves in which the arpeggio is played.

Direction:

The Direction parameter (see above) will now be extended by the octaves order. The melodic motif selected by the direction parameter mentioned previously will now be repeated throughout the different octaves, according to the following scheme: (Settings: **Voice Select** „Cntr“; **Octave Range** „4“):

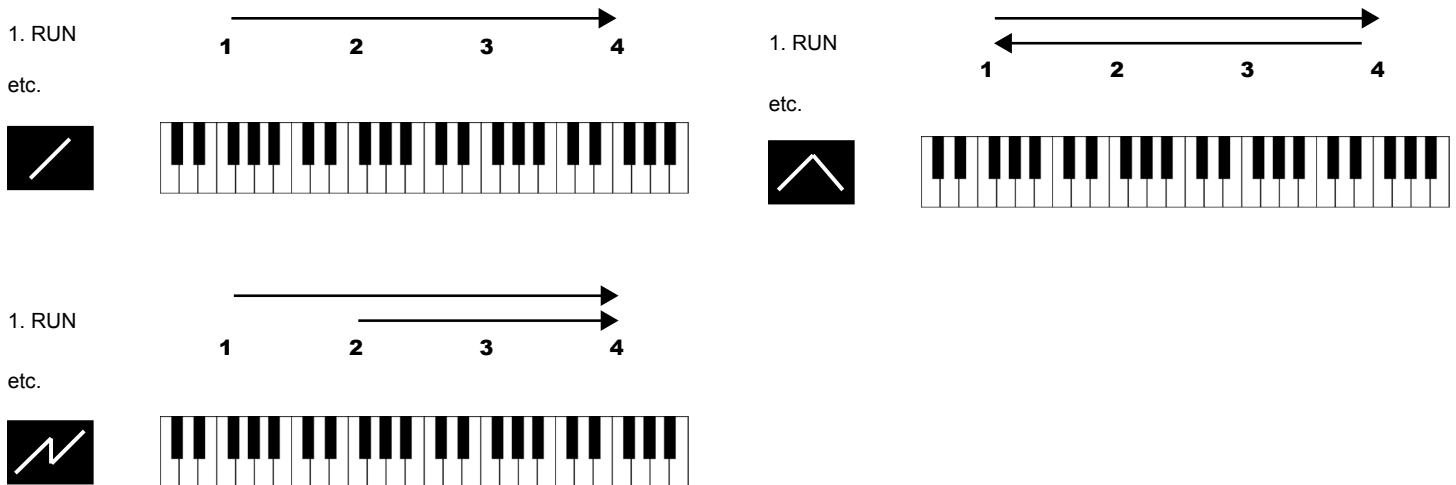

The combination of both direction parameters as well as the voice select function offers countless options – from simple „oldschool“ arpeggios to harp-style glissandi (or would that be glissandos?) up to weird sort-of-random sequences.

To make yourself more familiar with the direction parameter, we advise you to try out the arpeggiator with a relatively simple sound preset (e.g. „Plucky Brit“) and the clock settings „Counter“ and „¼“, and go from there.

The harmonic scale of the arpeggiator is determined by the parameters Scale and Root(-note, not beer) in the Pitch Factory section.

Gate

Velocity / Curve:



Here you can control the velocity scaling resp. its response characteristics. You can see the results in the graphic display.

EFFECTS

Factory sports a powerful effect section that will help you to beef up your sounds even more. It provides three effect slots connected in series with an ample selection of 13 effects each.

All effect slots are identical. You can switch their order as desired. Modulation effects (Chorus, Phaser, Flanger) use their own internal modulation source. In addition to this, you can modulate effect parameters using the [mod matrix](#).

If you decide not to use an effect slot (**Mix** parameter = 0), you should disable the respective slot. This will save CPU processing power.



In the upper line you will find three controls that are the same for all effect slots:



Enable/disable the effect slot with its **on/off** button.



Click on the **hand symbol** and drag the slot to another position while keeping down the mouse button.

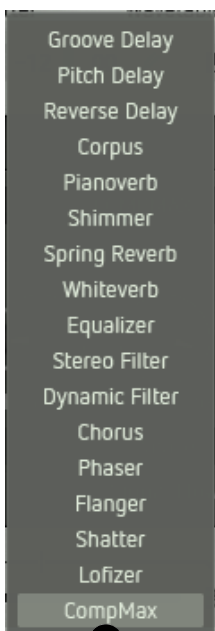

Select an effect by clicking on the **effects name**. A selection window will pop up. Load the desired effect by clicking on its name.



Select between the following effects:

Groove Delay:



A stereo delay for rhythmic echo effects. It sports two delay taps per channel. Their delay time can be shifted individually against each other.

- **Echoes:** Number of repeats... repeats... repeats... re....
- **Rotate:** Intensity of stereo panorama movement.
- **Tone:** Cuts the high frequencies of the echoes.
- **Stereo:** Controls the stereo width.
- **Time L/R:** Determines the delay time of left and right channel by 15 note values.
- **Lag R/L:** Determines the offset of the second delay tap. The value is a factor that is multiplied with the Time value. This is to make sure that the second delay tap will also be synced accurately to the rhythm.

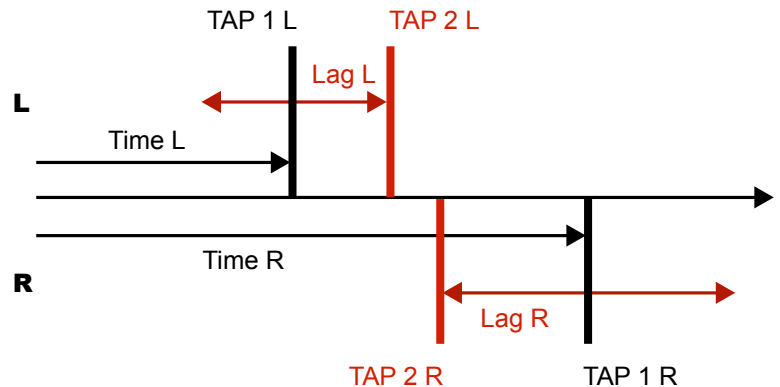
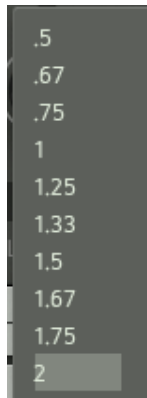

- **Mix:** Controls the effect level within the output signal.

Pitch Delay:

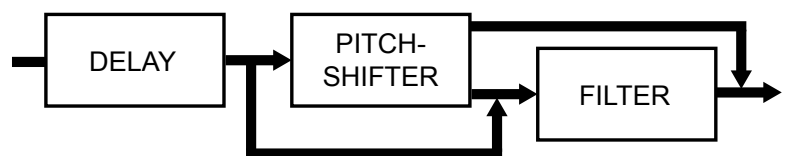

A stereo delay with pitch shifter and filter. Arpeggios are possible as well as tape-echo effects and weird flanger or comb filter sounds.

- **Time L/R:** Determines the delay time of the left and right channels. The values available depend on the **Sync** setting.
- **Sync L/R:**
 - **Sync:** The **Time** control is scaled and selects only even note values.
 - **Sync TP:** The **Time** control is scaled and selects even note values and triplets.
 - **Free:** The delay time is controlled continuously by milliseconds.
- **Feedback:** Number of repeats, up to self-oscillation.
- **Pitch:** Amount of pitch shifting.
- **Mode:** Determines the signal routing within the effect and thus the operation of the integrated filter:

Pitch: No filter in the signal path. Turning the **pitch control** changes the pitch.

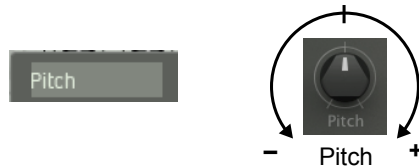

+ Fltr: The pitch shifter is combined with a filter (lowpass, combfilter, highpass each with or without a fixed resonance (Q)). By turning the **pitch control** clockwise, the pitch is changed and the cutoff frequency will be increased and vice versa.

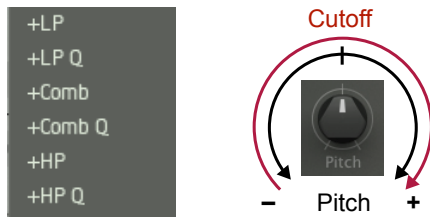

- Fltr: As above, but cutoff shift will be reversed.



Fltr: The **pitch control** exclusively controls the cutoff frequency. No pitch shifting.



- **Mix:** Controls the effect level within the output signal.

Reverse Delay:



A stereo delay producing some kind of sdrawkcab, erm, backwards effect of a reversed tape. Great for rhythmical effects, or for summoning the Dark Lord (instant subliminal messages also work great... try klim emos teg or redrum or the like the next time round).

- **Time L/R:** Determines the delay time of the left and right channels. The values available depend on the **Scale** setting.
- **Sync L/R:**
 - **Sync:** The **Time** control is scaled and selects only even note values.
 - **Sync TP:** The **Time** control is scaled and selects even note values and triplets.
 - **Free:** The delay time is controlled continuously by milliseconds.
- **Feedback:** Number of repeats.. repea... okay, we have already had a laugh here.
- **Fade:** Controls the intensity of the backwards effect.
- **Mix:** Controls the effect level within the output signal.

Corpus:



Emulates the effect of a resonant body of definable shape and material. Provides an ambience effect without audible reverb tail while colouring the sound at the same time – most interesting in combination with the „Waveguide“ oscillator model.

- **Size:** Simulates the size of the resonant body.
- **Tail:** Controls the decay time of the ambience effect.
- **Shape:** Simulates the shape of the resonant body.
- **Material:** Simulates the material of the resonant body.
- **Mix:** Controls the effect level within the output signal.

Pianoverb:



Combines a reverb with a resonator effect. The sound characteristics of the reverb can be tweaked across a wide range and resemble the sonic properties inside a piano enclosure. By using the right parameter values, you can create stunning „impossible rooms“ effects.

- **Size:** Simulates the size of the resonant body / room
- **Tail:** Controls the decay time.
- **Color:** Colours the reverb sound from dull to bright.
- **Reso:** Simulates resonances and alters the reverb sound.
- **Mix:** Controls the effect level within the output signal.

Shimmer:

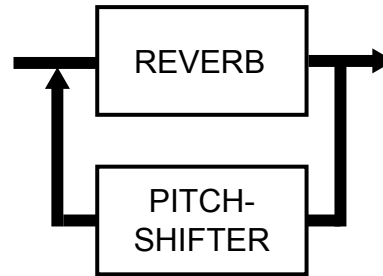

Combines a reverb with a pitch-shifter effect – cool...! The reverb tail is pitch-shifted by an octave up/down. Nice for the emulation of very large rooms / halls and the creation of weird ambient effects.

- **Size:** Simulates the size of the room.
- **Tail:** Controls the decay time of the reverb tail.
- **Tune:** Amount of pitch-shifting (+/- 12 semitones).
- **Effect:** Controls the level of the pitch-shifted signal portion.
- **Mix:** Controls the effect level within the output signal.

Spring Reverb:



Emulates the typical sound of a spring reverb (i. e. the “boink!” factor).

- **Size:** Simulates the room size resp. the length of the spring.
- **Tail:** Controls the decay time of the reverb tail.
- **Color:** Cuts high frequencies.
- **Emphasis:** Another filter to sculpt the sound with.
- **Tension:** Simulates the tension of the spring in four discrete steps.
- **Lo-Cut:** Cuts low frequencies from the reverb signal in four discrete steps – this is to avoid „booming“ noise.
- **Mix:** Controls the effect level within the output signal.

Whiteverb:



Another reverb effect with just a few but very effective parameters – very useful for many applications. Can do a very good job when used only in small amounts.

- **Size:** Simulates the room size resp. the size of the plate.
- **Tail:** Controls the decay time of the reverb tail.
- **Hi-Cut:** Cuts high frequencies from the reverb signal.
- **Mix:** Controls the effect level within the output signal.

Equalizer:



A fully parametric EQ with two bands that can be overlapping.

- **Freq 1:** Center frequency of the first band.
- **Level 1:** Cut/boost of the first band.
- **Q 1:** Width of the first band in six discrete steps (1 – 6 octaves).
- **Freq 2:** Center frequency of the second band.
- **Level 2:** Cut/boost of the second band.
- **Q 2:** Width of the second band in six discrete steps (1 – 6 octaves).
- **Mix:** Controls the effect level within the output signal.

Stereo Filter:



A multimode filter with resonance but no internal modulation. By modulating it via the [mod matrix](#), it can be used as a fully-fledged second filter in Factory's signal path. With modulation also useful for creating stereo panning effects.

- **Type:** Determines the filter characteristics (lowpass, bandpass, highpass).
- **Cutoff:** Operating point of the filter (cutoff resp. center frequency).

- **Reso:** Controls the intensity of the resonance. Emphasizes frequencies around the cutoff frequency point.
- **Stereo:** Controls the cutoff-offset between left and right channel and thus the stereo position of the effect signal.
- **Mix:** Controls the effect level within the output signal.

Dynamic Filter:



A multimode filter with resonance and internal modulation by an envelope follower. Provides level-controlled wah-wah and flanger-like effects.

- **Type:** Determines the filter characteristics (lowpass, bandpass, highpass).
- **Cutoff:** Operating point of the filter (cutoff resp. center frequency).
- **Reso:** Controls the intensity of the resonance. “Peaks” the sound around the cutoff frequency.
- **Amount:** Sets the threshold level of the envelope follower and controls the cutoff resp. the intensity of the effect, depending on the level of the input signal.
- **Rate:** Determines the duration of the envelope and thus the speed of the filter effect from slow (left) to fast (right).
- **Mix:** Controls the effect level within the output signal.

Chorus:



A classic stereo chorus, would you believe – simple but effective. Great not only for pad sounds.

- **Rate:** Controls the speed of the internal modulation.
- **Depth:** Controls the internal modulation depth resp. the intensity of the effect.
- **Stereo:** Controls the stereo width of the effect.
- **Mix:** Controls the effect level within the output signal.

Phaser:

Also a classic: the phaser effect.

- **Rate:** Controls the speed of the internal modulation.
- **Color:** Changes the sonic response of the effect.
- **Depth:** Controls the internal modulation depth resp. the intensity of the effect.
- **Mix:** Controls the effect level in the output signal.

Flanger:

A flanger with flexible control and a wide palette of sounds.

- **Rate:** Controls the speed of the internal modulation.
- **Amount:** Controls the internal modulation depth.
- **Depth:** Controls the delay time and produces either flanging, doubling, or combfilter effects.
- **Feedback:** Determines the feedback intensity.
- **Mix:** Controls the effect level within the output signal.

Shatter:

Provides a combination of a tremolo effect (level vibrato) and a filter vibrato. Very good response to dynamic input signals.

- **Rate:** Controls the speed of the internal modulation.
- **Filter:** Alters the effects sound from dull to bright colours.
- **Mix:** Controls the effect level within the output signal.

Lofizer:



A grinding lo-fi effect which will always be useful when you believe your nicest sound creations to be a tad too nice perhaps...

- **Reduce:** Decreases the bit rate of the signal.
- **Crush:** A really evil bit crusher. Depending on the settings of the other parameters, the signal might become inaudible. Tweak carefully.
- **Sinize:** The signal is modulated by a sine wave which results in a sound a ringmodulator would produce. The control determines the frequency of the sinewave. Turned fully counter-clockwise, this modulation effect will be disabled (off).
- **Distorsion:** Provides a mild level boost with harmonic distortion – nice and nasty... Turned fully counter-clockwise, the distorsion effect will be disabled (off).
- **Mix:** Controls the effect level within the output signal.

Compmax:

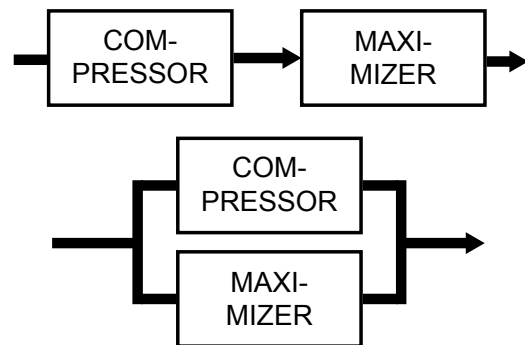

A very handy tool for controlling volume levels and increasing overall loudness. You can boost sounds that appear a little weak – also very handy for e.g. drum- and percussion loops / rhythmic sounds. If necessary, reduce Factorys output level (**Vol**) a bit.

- **Compress:** Controls operating point of the compressor and thus the intensity of the level compression.
- **Attack:** Controls the attack response time of the compressor in five discrete steps.
- **Release:** Controls the release response time of the compressor – synced to Factorys clock source. Makes the creation of rhythmically „pumping” effects easy.
- **Maximize:** Determines the intensity of the gain maximization.
- **Release:** Controls the release response time of the maximizers – also synced to Factorys clock source.
- **Signal Flow:** Determines whether compressor and maximizer work in series or in parallel. To obtain heavy pumping effects, please use serial routing and adjust all parameters carefully.
- **Mix:** Controls the effect level within the output signal.

Modulating effect parameters:

Most of the effect parameters can be controlled via the modulation matrix. This is an easy way to create very interesting and catchy sounds. Imagine delay patterns controlled by the sequencer, or a bit-reduction/distortion effect controlled by keyboard pressure... Here we go:

First, create a modulation path in the matrix with the desired effect slot as modulation destination (**FX 1**, **FX 2** or **FX 3**).

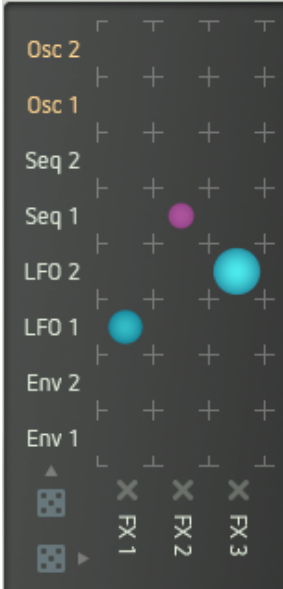

Now click on one (or more) of the **arrow symbols**, placed right above every effect parameter control. The corresponding effect parameter(s) will now be modulated. Range, Depth and rate of the modulation will again be displayed by a colored ring / bar on the corresponding control element.



SETTINGS

This window hides some parameters with global settings. Beneath the Sound-fader you will find your serial number and your Factorys current validity state.

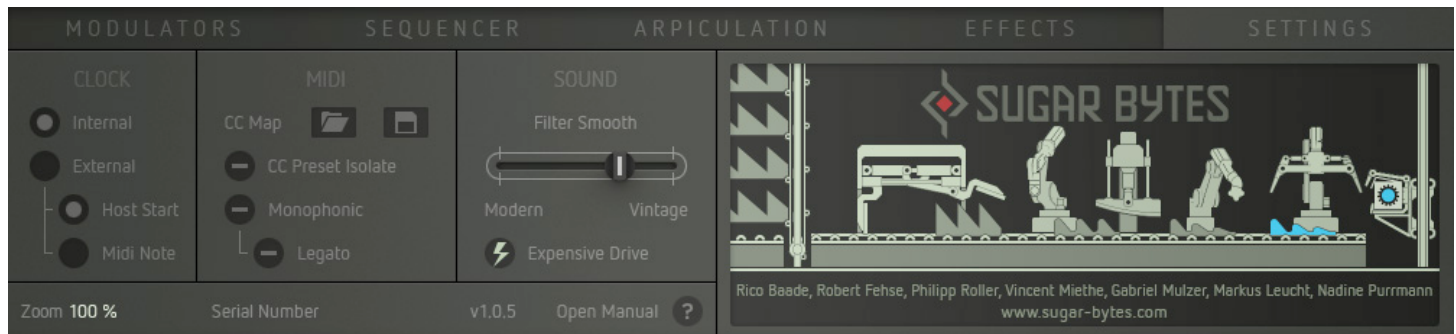

Clock:

Determines the clock source for Factorys timing-related parameters (sequencer and arpeggiator speed, LFO rate etc). Available settings are:

- **Internal:** Factorys internal clock source is active.
- **External:** Factory processes an external clock from the host sequencer. With „**Host Start**“ enabled, Factory will also require start/stop commands etc. from the host DAW.

MIDI:

Provides Factorys MIDI settings:

- **CC Map:** This function provides load and save of MIDI controller mappings independent of a sound preset. Click the **folder/disk symbols** to open your computers file browser and save resp. select and load the desired CC map.
- **CC Preset Isolate:** With the **minus symbol** visible, a preset will be loaded together with its associated controller mapping. When the **check is placed**, the selected preset will be loaded without its associated controller mapping. The currently active controller mapping remains active and, if desired, can be replaced by using the „**CC Map**“ load/save function.
- **Monophonic/Legato:** If the „**Monophonic**“ check mark is placed, Factory works monophonic. With the „**Legato**“ check mark placed, new legato notes will not trigger the envelopes

Sound:

Here you can tailor the sound character of the filter / drive section to your personal taste. You will find a detailed description of these parameters in the filter / drive chapter.

Extras:

Here you can find your Factorys **version-** and **serial numbers**. Please make sure, that you are always running the latest version. By clicking „**Open Manual**“, you are directed to Factorys user manual.

Adjust the Factory GUI to your monitor screen size via the **Zoom** menu or click into an empty area in Factory, then hold down the Ctrl key and press „+“ to increase the size or „-“ to decrease the size.

REALTIME CONTROLLERS

In addition to the keyboard, Factory also sports a pitch bender, a modwheel, and a Morph fader.



Keyboard:

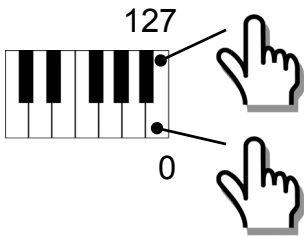

Factory's keyboard generates velocity data: Depending on the contact point on a key, the velocity values will change.

All other keyboard-related parameters can be found in the [Pitch Factory](#) window.

Pitch Bender:

Modulation depth and direction are also defined in the [Arpication](#) window.

Modwheel:

The setup of the modwheel is performed with the assistance of the [modulation matrix](#).

Morph Fader: [\(Watch video\)](#)

The Morph fader enables you to perform complex timbre changes by just one single fader movement. You can blend between two settings „A“ and „B“. This simple example says more than a thousand words:

- Click the **record** button of the Morph fader. Depending on the faders current position, the „A“ or „B“ button „lights up“.



- Move some **parameter knobs** and **faders**.
- Now move the **Morph fader** and watch the control surface. All knob and fader movements performed after clicking the record button have been recorded and are now reproduced simultaneously by moving just the Morph fader.

Each additional parameter movement will also be recorded and reproduced by the Morph fader.



- Again, click on the **record** button of the Morph fader. Its record function will now be disabled. All previously performed knob and fader movements will still be reproduced, but no new ones will be recorded.

- As soon as you enable the record function again, knob and fader movements will be recorded on top of the existing ones etc.
- By clicking on the **X**-symbol, all previously recorded knob and fader movements will be erased. The latest knob and fader settings can now become the starting point of further sound editing.

Tip: The Morph fader itself can be remote-controlled from a MIDI controller. It can be very cool to assign the mod wheels MIDI CC (# 1) to the morph fader (please see below „[MIDI CC assignment](#)“).

The Morph fader records all continuously variable parameters, i.e. knobs and faders. This includes the modulation depths defined in the mod matrix, as well as its knob settings and the random function (dice symbol). The tuning parameters of the oscillators, clock divider settings of the master clock and sequencer tracks as well as the sequencers' global swing will also be recorded. Switching functions or parameter values that are selected via a pop-up menu (e.g. Time-parameter of the Groove Delay) will not be recorded by the Morph fader.

MIDI CC ASSIGNMENT

Most of the panel controls can be assigned to a MIDI CC number. This includes the modulation depths defined in the [mod matrix](#), as well as many [sequencer](#)- and most [articulation](#) parameters.

- Simply right-click on the desired control. A popup window opens up, usually showing a not assigned control by default.
- **MIDI learn:** Click on the **left MIDI socket symbol**. Now move a control of your MIDI controller device. A MIDI learn function automatically assigns it to Factory's selected control.

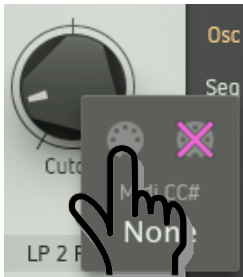

- **Manual input:** Click into the field labelled „number“ and key in the desired CC number.



- Click somewhere into the GUI area to close the popup window.
- To erase the assignment, open up the popup window and click on the crossed out MIDI socket symbol.

INSTALLATION

Install Factory

Download (requires login) the latest version [here](#).

Double-click on the installer and follow exactly the instructions provided by the installation process.

The standalone version and manual will be installed to:

Windows: C:\Program Files\Sugar Bytes\Factory
OS X: /Application/Sugar Bytes/Factory

Presets will be installed into Documents\Sugar Bytes\Factory.

Important: Do not relocate Factory presets after installation!

WINDOWS 32bit

Default installation paths:

VST C:\Program Files\Steinberg\Vstplugins
AAX C:\Program Files\Common Files\Avid\Audio\Plug-Ins

WINDOWS 64bit

Note that all 64-bit plugins are in C:\Program Files and your 32-bit plugins are located in C:\Program Files (x86).

Make sure you have installed the correct version (32- or 64-bit). You can check whether your DAW is running in 64-bit or 32-bit mode by opening the Task Manager while it is running.

Default installation paths for the 32-bit version:

VST C:\Program Files (x86)\Steinberg\Vstplugins
AAX C:\Program Files (x86)\Common Files\Avid\Audio\Plug-Ins

Default installation paths for the 64-bit version:

VST C:\Program Files\Common Files\Steinberg\VST2
AAX C:\Program Files\Common Files\Avid\Audio\Plug-Ins

OS X

All versions of Factory will be installed by default.

Our plugins are Universal Binaries that are both 32-bit and 64-bit compatible. Depending on your host, the proper one will be loaded and used.

AAX is supported by Pro Tools 10.3.5 and higher.

Default installation paths:

VST /Library/Audio/Plug-Ins/VST/

AU /Library/Audio/Plug-Ins/Components/

AAX Macintosh HD/Library/Application Support/Avid/Audio/Plug-Ins

Uninstalling

To uninstall Factory, please follow the instructions:

Windows

Uninstall Factory under Control Panel>Add/Remove Software.

OS X

Delete all the following files and folders:

/Applications/Sugar Bytes/Factory

/Library/Audio/Plug-Ins/VST/Factory.vst

/Library/Audio/Plug-Ins/Components/Factory.component

/Library/Application Support/Avid/Audio/Plug-Ins/Factory.aaxplugin

~/Documents/Sugar Bytes/Factory

~/Library/Preferences/com.sugar-bytes.Factory.plist

,~' means: /Users/YOURLOGINNAME (your home folder)

(Please note that in OSX 10.7 and later, the user Library folder is hidden. In case you cannot locate your Library folder in the Finder: Select „Go to Folder“ from the Finder's Go menu and enter ,~/Library'.)

Authorization

The serial number is requested during installation. If the serial number is missing or incorrect, the product will not produce any sound. Check the **Settings Tab** to verify whether your **serial number** is VALID. Manually entering the correct serial number there or performing a quick reinstall there, should fix any issues.

License

License covers both the OS X and Windows version and can be activated for two computers. For use on more than two computers, please buy an additional license.

You may resell the software three months or more after purchase. We will need to charge you for bureaucratic effort, though, and have to ask for a license transfer voucher, apologies for that! This voucher is available in our online shop for a mere EUR 9,-.

Host integration

Factory works as a VST / AU / AAX plugin in the most common DAW hosts. When installing, please make sure to install the right plugin-type and – if using Windows – the right version (32 or 64 bit).

Some hosts need to perform a plugin rescan when a newly installed plugin is launched for the first time. Please find all detailed instructions for your DAW below.

Cubase

Perform a full rescan in the Cubase plugin manager.

Make sure that the Factory.dll (Win) or Factory.vst (OS X) file is contained in Cubase's assigned VST Plugins folder.

With Windows, make sure you are installing the correct version (32 or 64-bit).

You can check whether Cubase is running at 64-bit or 32-bit when opening the task manager while Cubase is running.



Load Factory as Instrument into an Instrument track.

Ableton Live

When using Mac OS X, we recommend using the VST version of Factory in Live.

With Windows, make sure you are installing the correct version (32 or 64-bit).

With Windows, you can check whether Live is running in 64-bit or 32-bit mode when opening the task manager while Live is running.

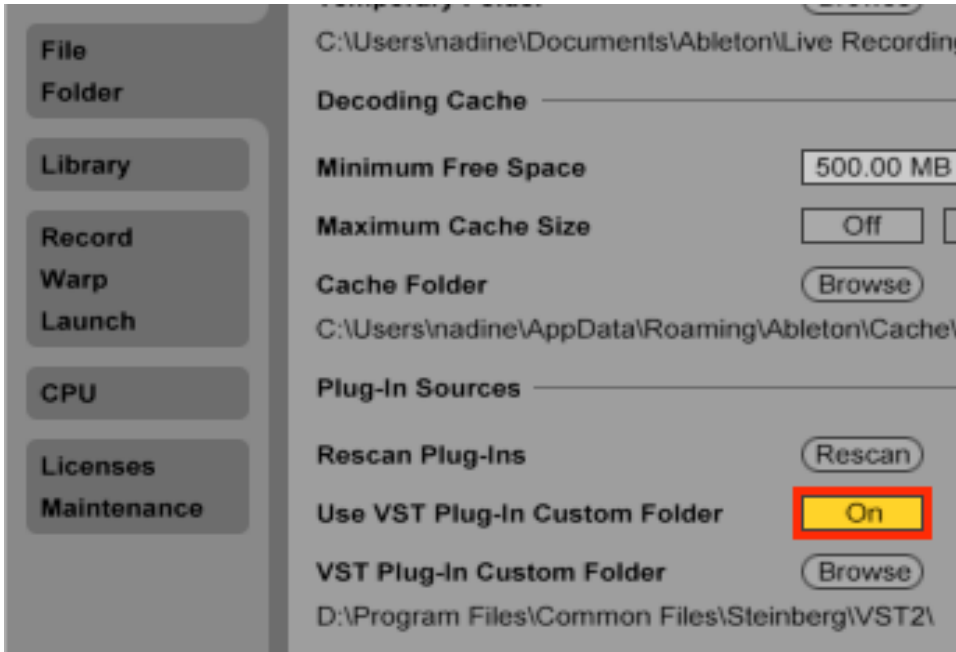

Please note: With Ableton Live, plugins sometimes will be marked as unloadable and not rescanned automatically.

If this happens to be the case, force a rescan by unchecking and checking the 'Use custom VST Folder' checkbox in Preferences/File Folder/Plug-In Sources.



Set up a MIDI track and insert Factory as instrument.

ProTools

When installing Factory, select AAX plug-in format.
(AAX is supported by Pro Tools 10.3.5 and higher.)

Use Factory as an instrument.

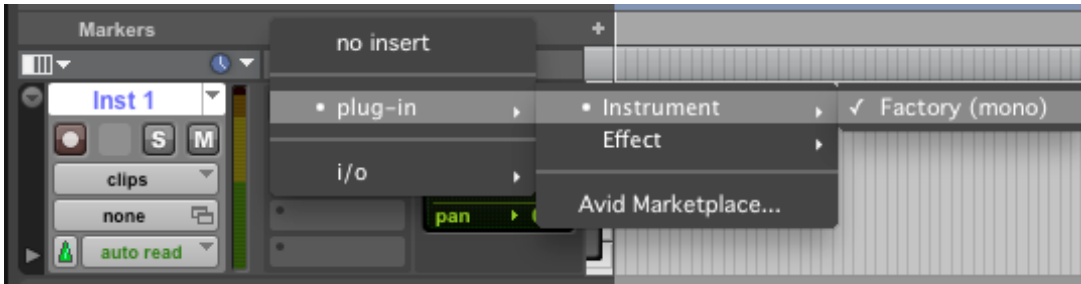

Studio One

Go to the Studio One menu and choose Options. Click Locations, then VST Plug-Ins.

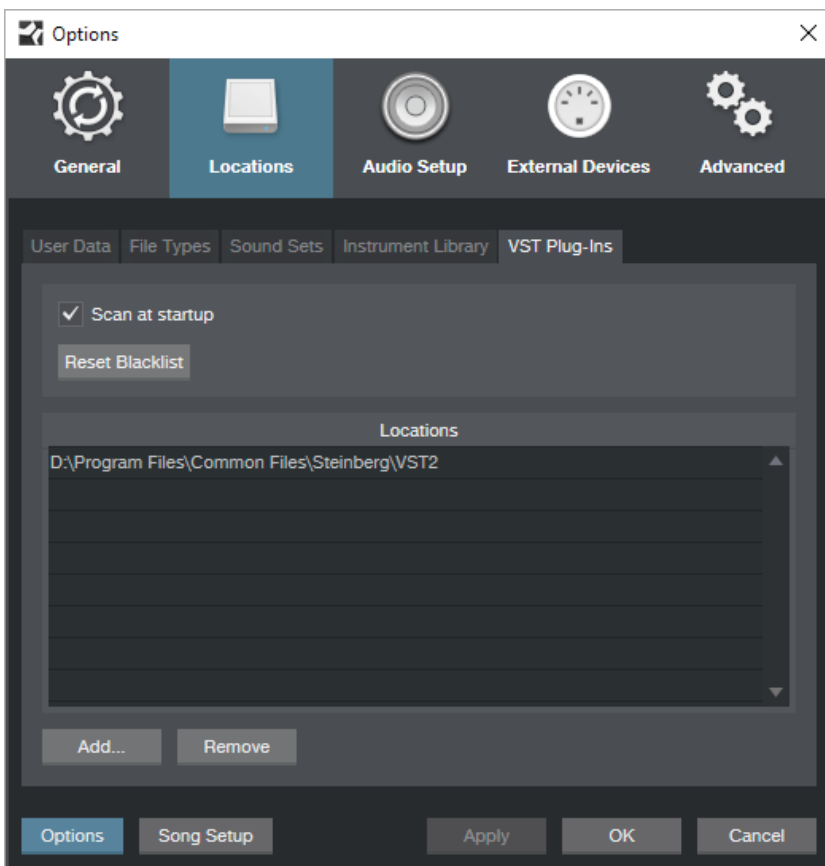

Click the Add... button and select your VST Plugins folder. Press OK, then close and reopen Studio One. If you cannot see the plugin, return to the options / locations screen of Studio One and click the Reset Blacklist button. Then close and open Studio One again.

Create an instrument track and pick Factory up from the Instrument list.

Sonar

Make sure that Factory is installed in the VST Plugins folder used by Sonar, and that you have installed the correct version (32- or 64-bit).

Insert Factory as a „soft synth“.

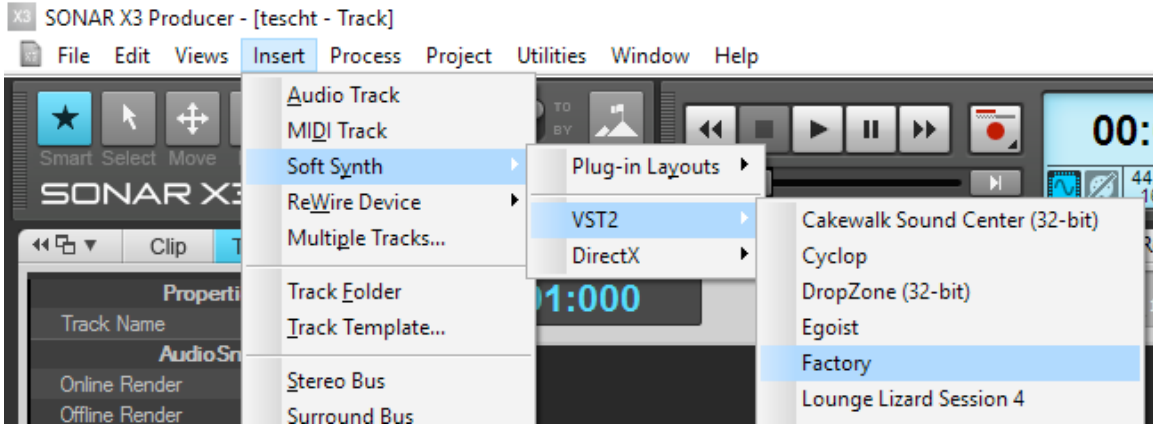

Logic

Select Factory as an AU-Instrument from the I/O dialogue of a Software Instrument track.

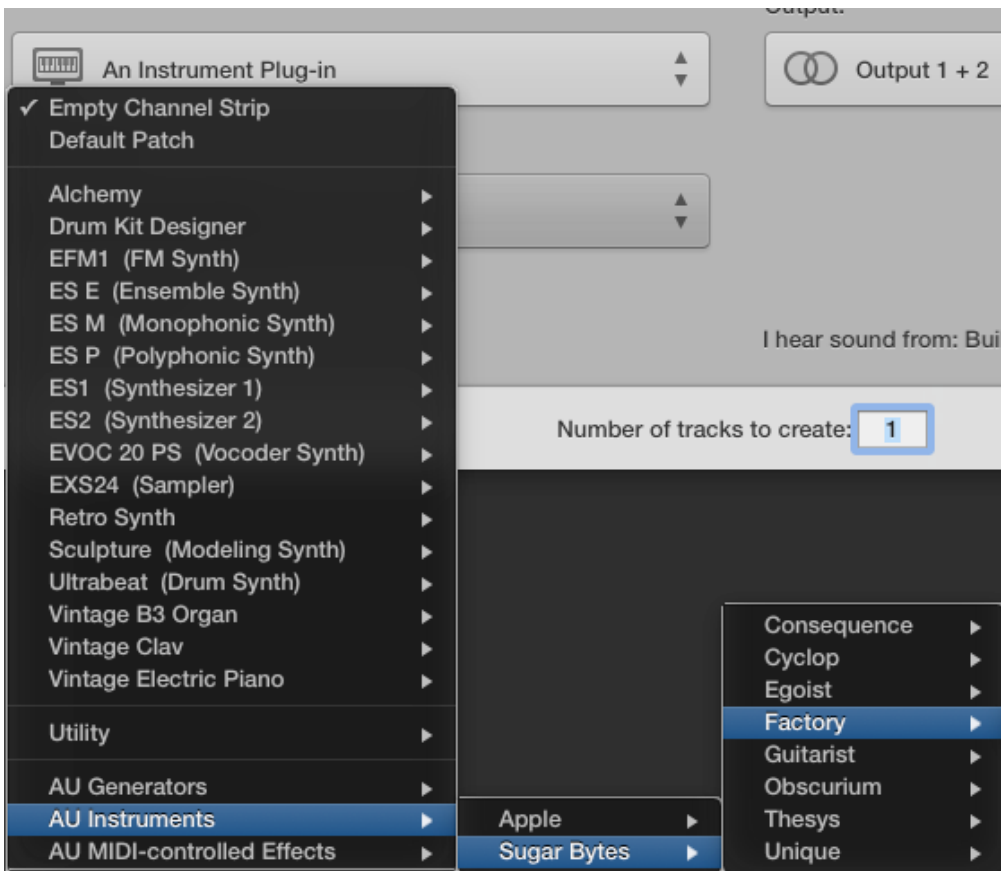

FL Studio

Go to Channels>Add one>More...

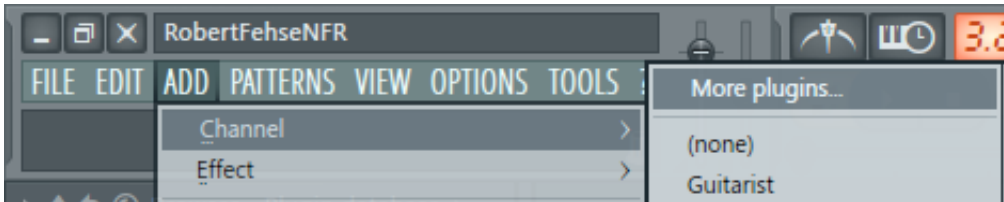

There you should find Factory and perform a refresh.

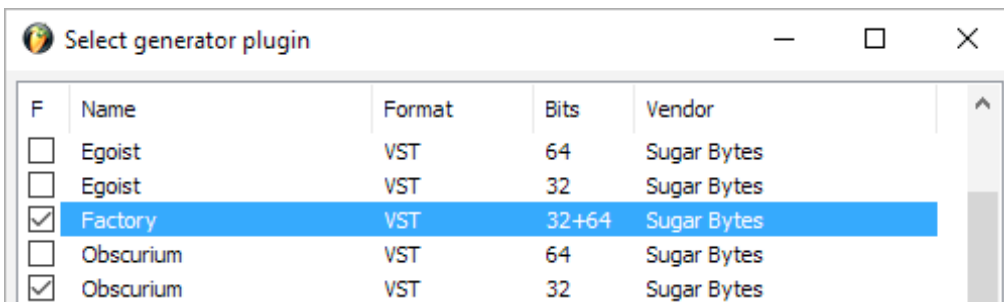

You can now open Factory in the Mixer Inserts

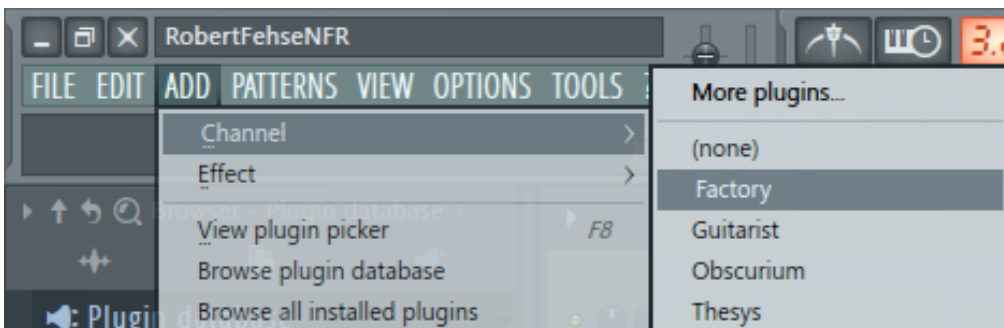

MIDI remote control via host

All the relevant parameters of Factory can be controlled via host automation and MIDI controllers.

Simply right-click/Ctrl+click a control to activate the **MIDI Learn option**.

Native Kontrol Standard NKS

Factory supports Native's NKS standard, giving you the same deep integration with NI controllers like Komplete Instruments.

The main features are a plug-and-play support of Factory's preset browser and trouble-free tagging/organisation for inclusion in the powerful Komplete Kontrol / Maschine browser. This lets you search by sound type (e.g. synth lead), character (e.g. dark), or any combination thereof.

We have strived for highly profound control of Factory's sound engine. Knobs and faders can be mapped to match those on the Kontrol and Maschine hardware in logical ways, with similar controls grouped by pages. For example: Skip to the Filter page and you will find the set of controls related to the filter characteristics.

All presets have been wrapped into .nkfs files which contain preset and tagging information as well as mapped out controls. Different genre and mood categories will speed up the producers' workflow when browsing through libraries, and help you keep your eyes off the computer screen.

Controller Mapping

We have strived for highly profound control of Factory's sound engine.

All mappings are consistent throughout the different presets.

There are ten pages available:

1) Performance

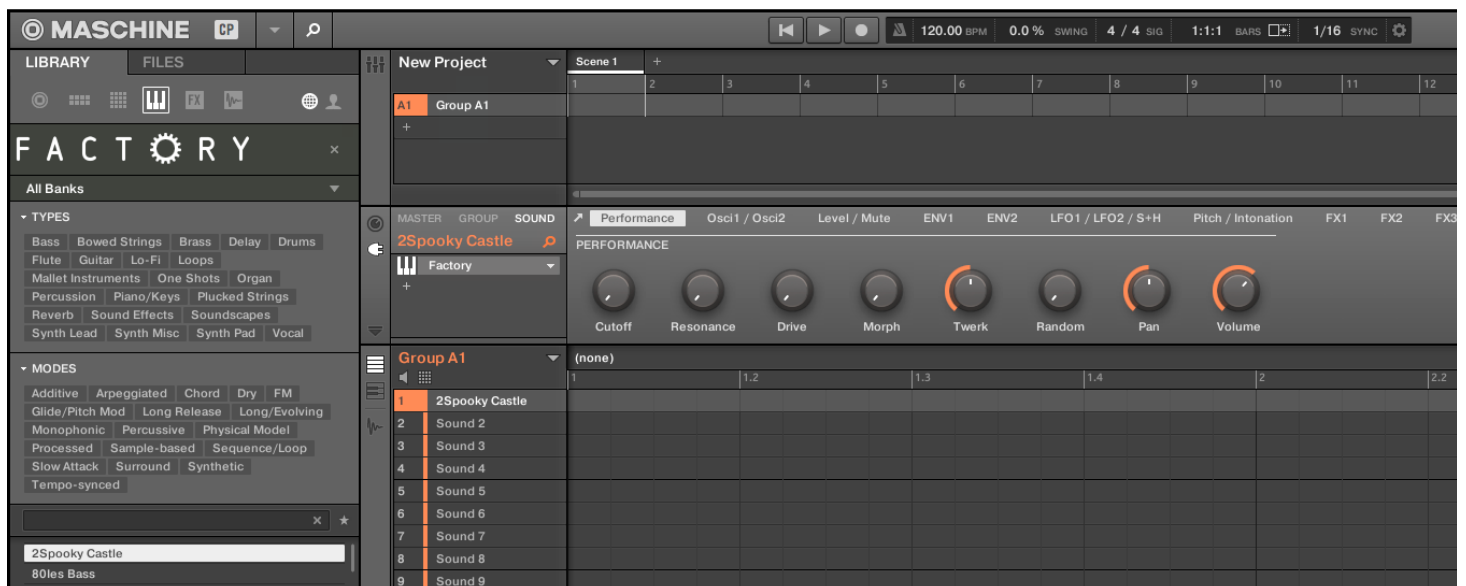

Provides direct access to Factory's most important parameters for most effective and intuitive sound tweaking. Here you will find the three controls of the filter/drive section (Cutoff, Resonance, Drive), the Morph fader, the Twerk control and a Random control, operating Factory's dice symbol (the latter two on the modulation matrix). Last, but not least, you will find Factory's panning and output volume controls here.

2) Osc1 / Osc2

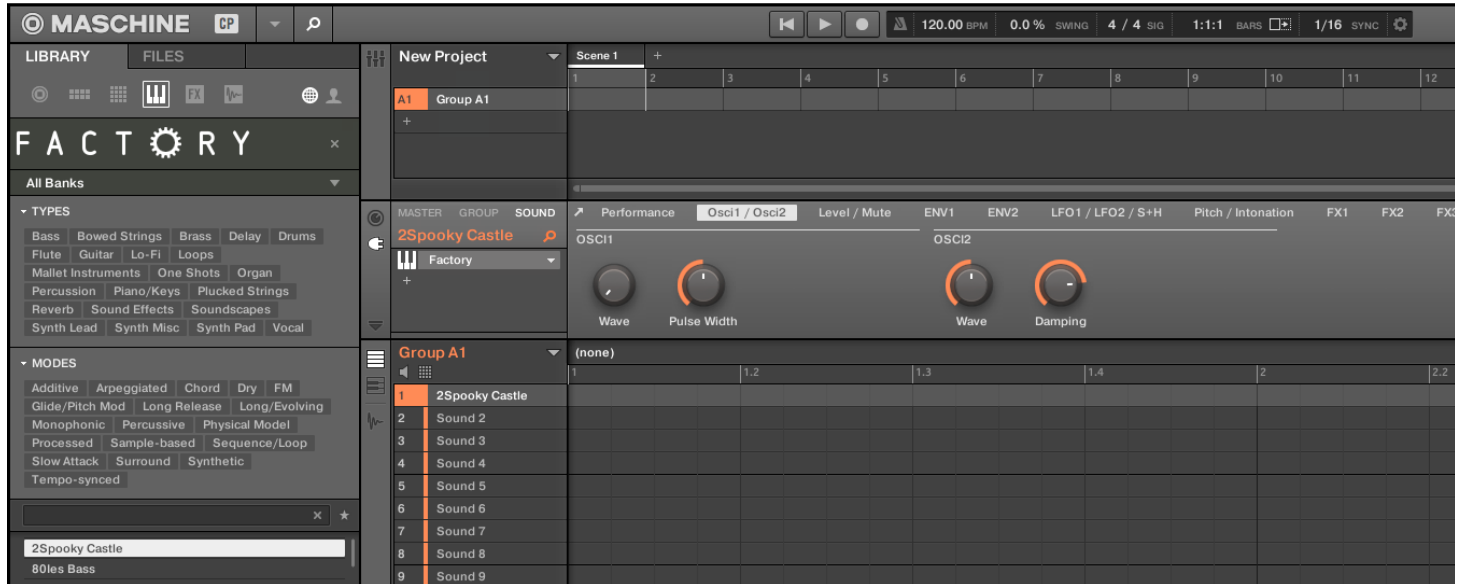

Features the controls of Factory’s oscillators. Depending on the oscillator model selected, you will find the knobs Osc A, Osc B, Osc C, and Osc D mirrored in NI Maschine, e.g.:

Transformer: Formant (Osc1 A) and Position (Osc 1 B).

Pulse Sync: Sync Freq (Osc1 A), Key Track (Osc1 B), Pulse Width (Osc1 C), and so on.

3) Level / Mute

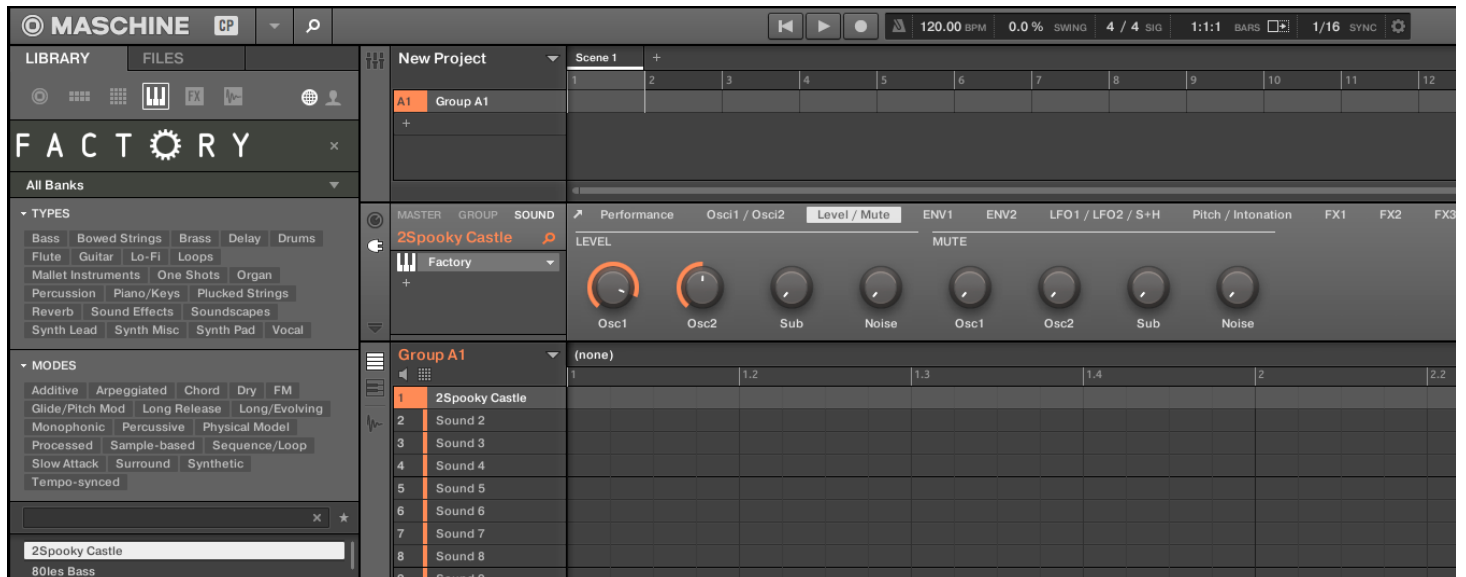

Features the level controls (faders!) and the mute functions of Factory’s mixer section. Mute / unmute Factory’s signal sources by turning the corresponding control clockwise or back.

4) + 5) ENV1 + ENV2

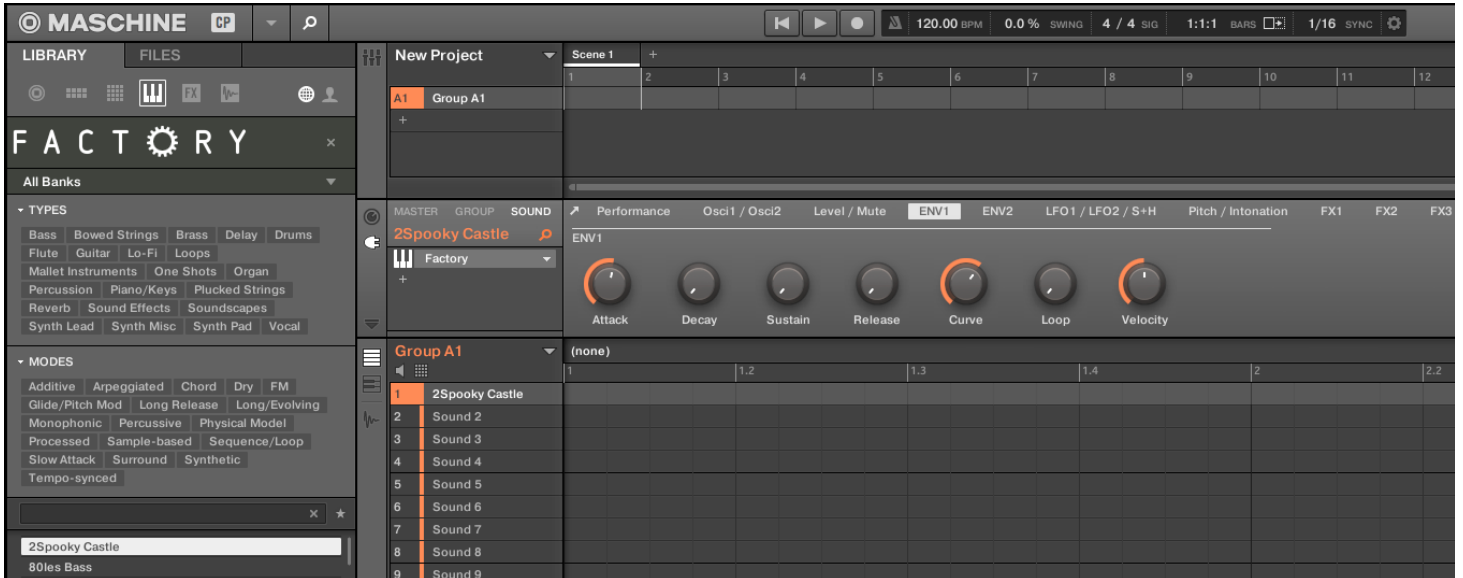

On these two identical pages you will find the controls of Factory’s two envelopes. Please note that Loop and Velocity are switching functions. Enable / disable them by turning the corresponding control clockwise or back.

6) LFO1 / LFO2 / S+H



Here you will find a selection of the most important controls of Factory’s LFOs as well as of the Sample+Hold module.

7) Pitch / Intonation

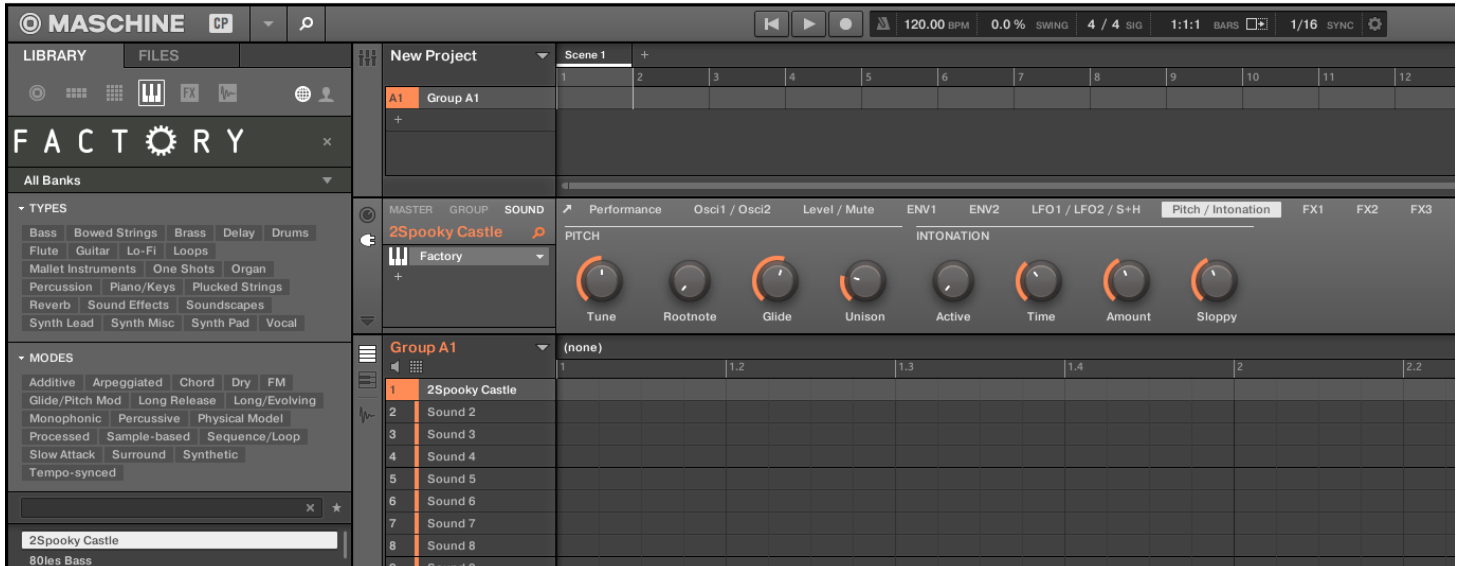

Features the most important controls of Factory’s Pitch Factory and Intonation modules. „Active“ equals Factory’s On/Off button. Enable / disable the Intonation module by turning the control clockwise or back.

8) + 9) + 10) FX1 + FX2 + FX3



These three identical pages feature the controls for Factory’s effects slots. Depending on the effect type selected, you will find the corresponding effect parameters (e.g. Size, Tail, Tune and Effect for „Shimmer“). The Mix parameter and the on/off function („Active“) are provided with every effect type.

CONTACT

Sugar Bytes GmbH | Purely made of passion

Greifswalder Str. 29 | 10405 Berlin, Germany

Tel. +49-30-60920395

info@sugar-bytes.de

www.sugar-bytes.com

